

FI Frame-Mounted End Suction Pumps

FI Series Pumps provide the ultimate in reliability and ease of installation for heating, air conditioning, pressure boosting, cooling water transfer, and water supply applications. Quiet, dependable and proven performance: that's the FI Series.

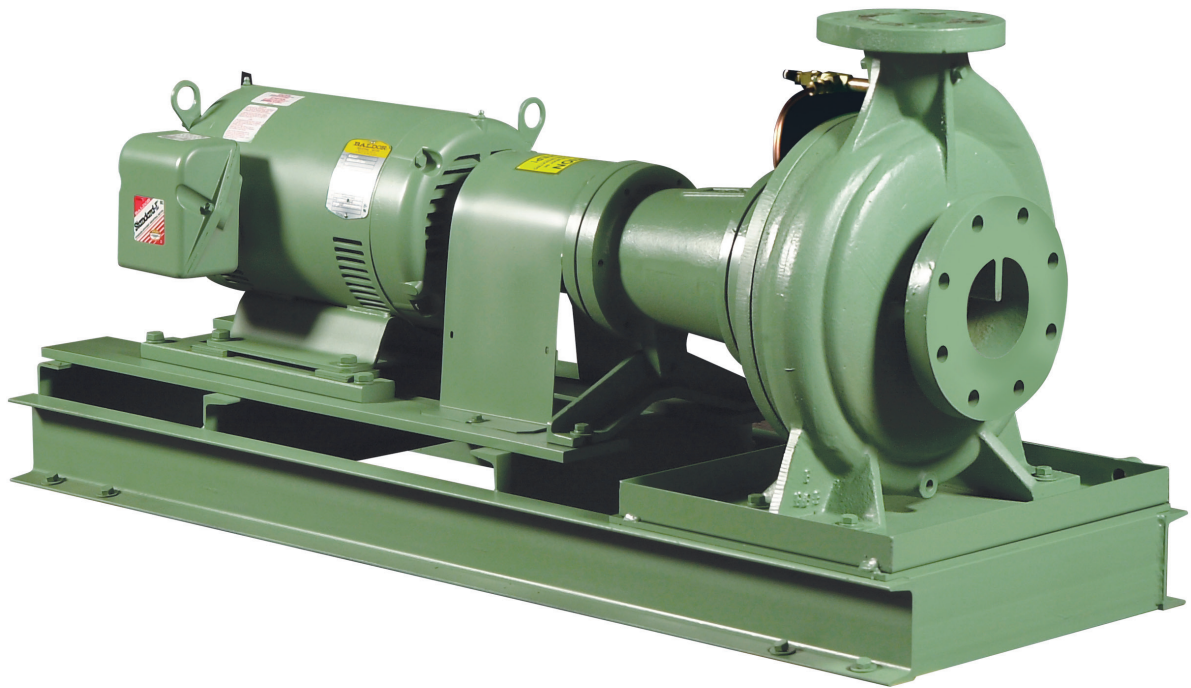

Features & Benefits

Quiet, dependable power and proven performance.

FI Series Pumps meet the latest standards for hydraulic performance and dimensional characteristics. Each is backed by Taco, Inc., a Worldwide leader in heating and cooling equipment for more than eight decades.

Improved bearing frame design features sealed for life bearings meeting all industry requirements for a minimum L 10 life of 60,000 hours. Optional regreaseable bearings are also available. Improved design also incorporates a unique sealing system which prevents the migration of water into the bearing frame. An easy-to-replace, slip-on shaft sleeve facilitates seal maintenance in the field and lowers maintenance costs. The exclusive dry shaft design protects the pump shaft by eliminating contact between the shaft and the circulating fluid. Corrosion-resistant shaft materials are generally not required. FI Pumps also feature flush seal line taps, allowing the installation of a filter to protect the seal from non-condensable particles present in systems. In addition, pressure tappings on suction and discharge connections are provided as a standard feature.

All FI Pumps are provided with a fully welded, rigid structural steel base, with enclosed ends and open grouting area. This combination reduces vibration and improves alignment.

Taco FI Pumps are ideally suited for a variety of applications, including heating, air conditioning, pressure boosting, cooling water transfer, and water supply.

Coupler guard designed for easy access.*

Rear pullout design allows pump to be serviced without disturbing the system piping.

Heavy duty coupling that is easy to install and align. This coupling is not only a superior coupling for typical across the line starting situations, but it is also ideally suited for the more diverse variable torque applications associated with variable frequency drives.

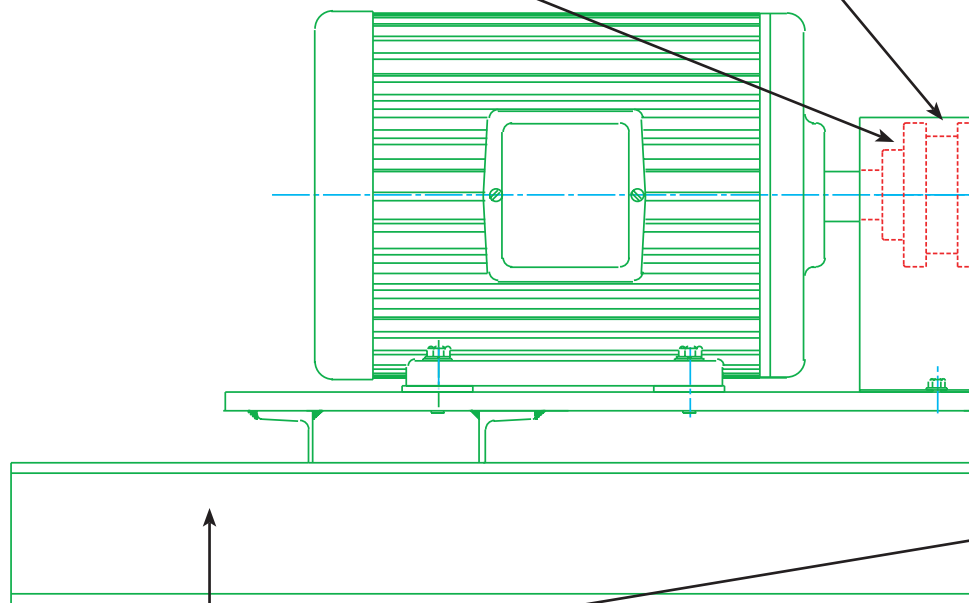

RIGID BASE

- Steel construction provides for rigid base installation.
- Built in drain pan (with 3/4" drain connection), Collects all condensate and seal leakage.
- Ample open space for easy grouting.
- The heavy-duty compact design provides a more stable platform, which meets or exceeds hydraulic institute and industry standards for rigidity and vibration dampening, the base design is an ideal solution for those tight mechanical room installations.
- Facilitates improved alignment and ease of grouting.

* Optional Coupler Guard available which conforms to ANSI 315.1 Section 8 and OSHA 1910.219

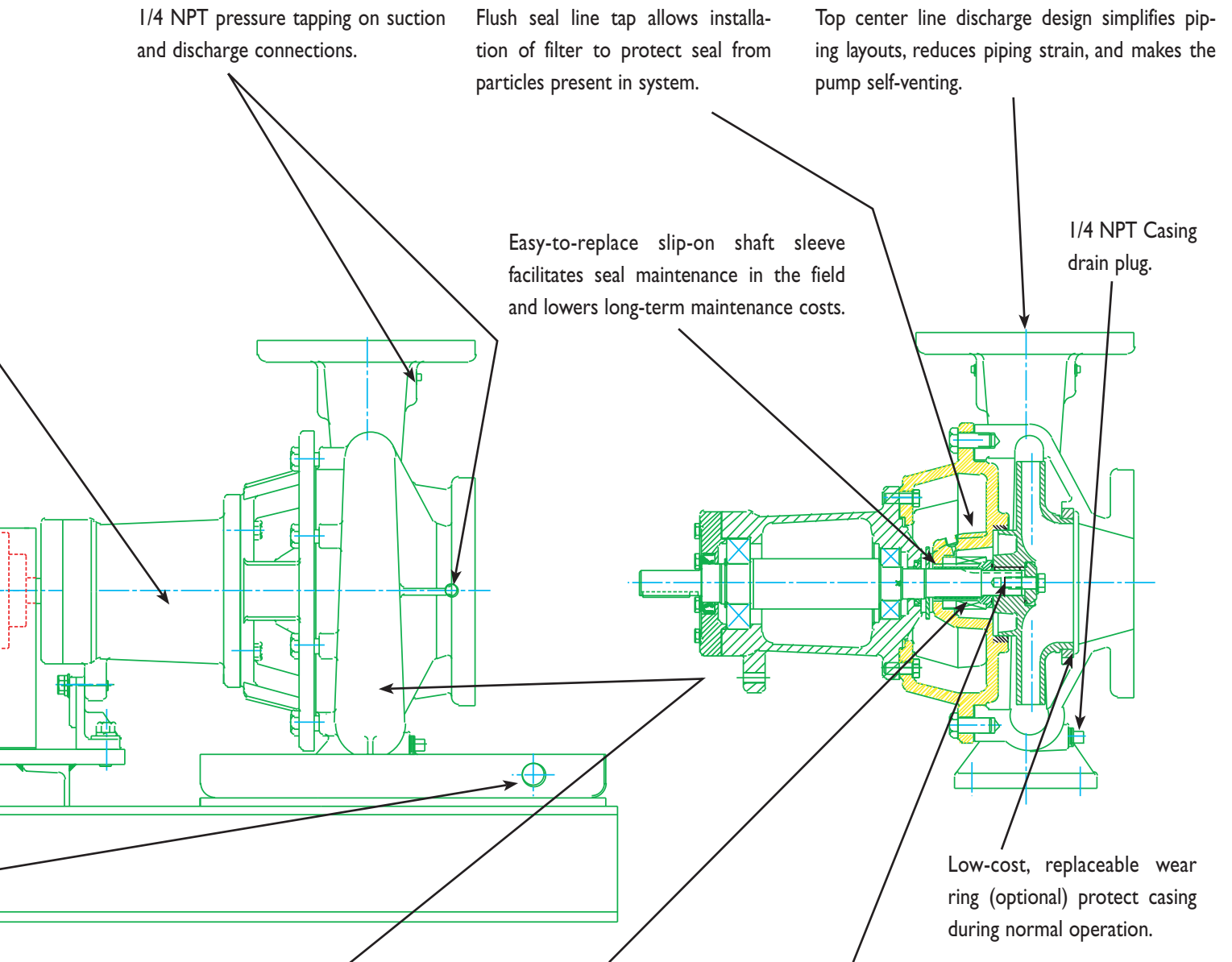

Cast iron casing with integrally cast feet enables pump to be bolted to base for sturdier installation and still allow back pull out without disturbing the piping.

Standard ceramic seals promote product flexibility: enables basic product offering to meet a wide range of application requirements.

DRY SHAFT DESIGN

- Ensures shaft is not exposed to the system fluid.
- Eliminates need for expensive corrosion-resistant shaft.
- Simplifies sleeve and seal removal/reinstallation.

Part I – Fundamentals

A centrifugal pump operated at constant speed delivers any capacity from zero to maximum depending on the head, design and suction conditions. Pump performance is most commonly shown by means of plotted curves which are graphical representations of a pump's performance characteristics. Pump curves present the average results obtained from testing several pumps of the same design under standardized test conditions. For a single family residential application, considerations other than flow and head are of relatively little economic or functional importance, since the total load is small and the equipment used is relatively standardized. For many smaller circulators, only the flow and pressure produced are represented on the performance curve (Fig. I-1).

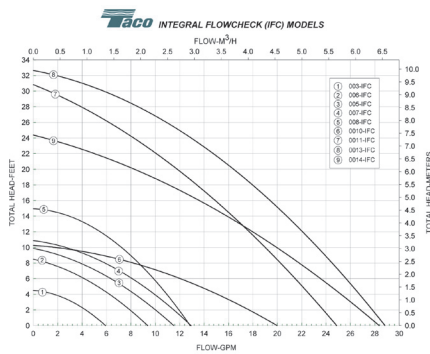

Fig. I-1

For larger and more complex buildings and systems, economic and functional considerations are more critical, and performance curves must relate the hydraulic efficiency, the power required, the shaft speed, and the net positive suction head required in addition to the flow and pressure produced (Fig. I-2).

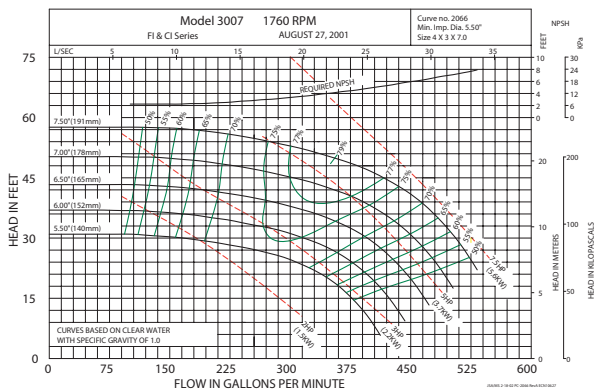

Fig. I-2

Pump performance curves show this interrelation of pump head, flow and efficiency for a specific impeller diameter and casing size. Since impellers of more than one diameter can usually be fitted in a given pump casing, pump curves show the performance of a given pump with impellers of various diameters. Often, a complete line of pumps of one design is available and a plot called a composite or quick selection curve can be used, to give a complete picture of the available head and flow for a given pump line (Fig. I-3).

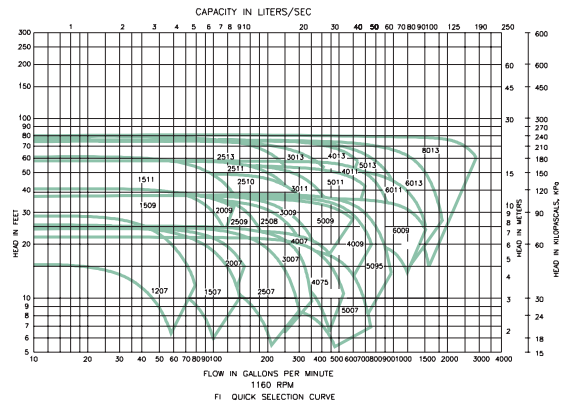

Fig. I-3

Such charts normally give flow, head and pump size only, and the specific performance curve must then be referred to for impeller diameter, efficiency, and other details. For most applications in our industry, pump curves are based on clear water with a specific gravity of 1.0.

Part II – The System Curve

Understanding a system curve, sometimes called a system head curve, is important because conditions in larger, more complex piping systems vary as a result of either controllable or uncontrollable changes. A pump can operate at any point of rating on its performance curve, depending on the actual total head of a particular system. Partially closing a valve in the pump discharge or changing the size or length of pipes are changes in system conditions that will alter the shape of a system curve and, in turn, affect pump flow. Each pump model has a definite capacity curve for a given impeller diameter and speed. Developing a system curve provides the means to determine at what point on that curve a pump will operate when used in a particular piping system.

Pipes, valves and fittings create resistance to flow or friction head. Developing the data to plot a system curve for a closed Hydronic system under pressure requires calculation of the total of these friction head losses. Friction tables are readily available that provide friction loss data for pipe, valves and fittings. These tables usually express the losses in terms of the equivalent length of straight pipe of the same size as the valve or fitting. Once the total system friction is determined, a plot can be made because this friction varies roughly as the square of the liquid flow in the system. This plot represents the SYSTEM CURVE. By laying the system curve over the pump performance curve, the pump flow can be determined (Fig. 2-1).

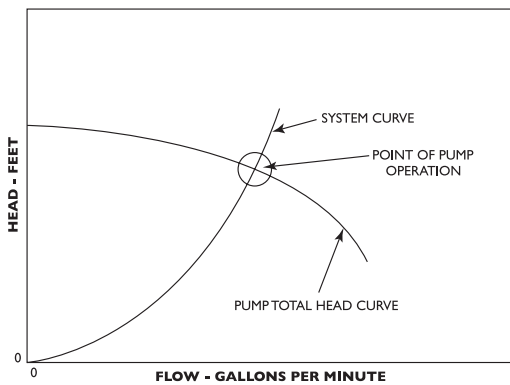

Fig. 2-1

Care must be taken that both pump head and friction are expressed in feet and that both are plotted on the same graph. The system curve will intersect the pump performance curve at the flow rate of the pump because this is the point at which the pump head is equal to the required system head for the same flow.

Fig. 2-2 illustrates the use of a discharge valve to change the system head to vary pump flow. Partially closing the valve shifts the operating point to a higher head or lower

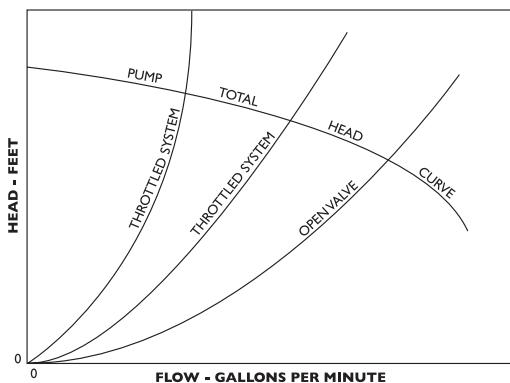

Fig. 2-2

flow capacity. Opening the valve has the opposite effect. Working the system curve against the pump performance curve for different total resistance possibilities provides the system designer important information with which to make pump and motor selection decisions for each system. A system curve is also an effective tool in analyzing system performance problems and choosing appropriate corrective action.

In an open Hydronic system, it may be necessary to add head to raise the liquid from a lower level to a higher level. Called static or elevation head, this amount is added to the friction head to determine the total system head curve. Fig. 2-3 illustrates a system curve developed by adding static head to the friction head resistance.

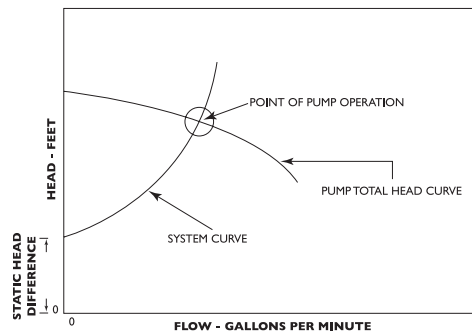

Fig. 2-3

Part III – Stable Curves, Unstable Curves And Parallel Pumping

One of the ways in which the multitude of possible performance curve shapes of centrifugal pumps can be subdivided is as stable and unstable. The head of a stable curve is highest at zero flow (shutoff) and decreases as the flow increases. This is illustrated by the curve of Pump 2 in Fig. 3 – 1.

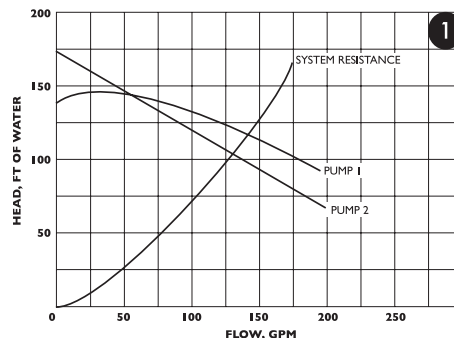

Fig. 3-1

Commercial Hydronic Application Information

So-called unstable curves are those with maximum head not at zero, but at 5 to 25 percent of maximum flow, as shown by the curve for Pump 1 in Fig. 3 – 1.

The term unstable, though commonly used, is rather unfortunate terminology in that it suggests unstable pump performance. Neither term refers to operating characteristic, however. Each is strictly a designation for a particular shape of curve. Both stable and unstable curves have advantages and disadvantages in design and application. It is left to the discretion of the designer to determine the shape of his curve.

In a vast majority of installations, whether the pump curve is stable or unstable is relatively unimportant, as the following examples of typical applications show.

Single Pump In Closed System

In a closed system, such as a Hydronic heating or cooling system, the function of the pump is to circulate the same quantity of fluid over and over again. Primary interest is in providing flow rate. No static head or lifting of fluid from one level to another takes place.

All system resistance curves originate at zero flow any head. Any pump, no matter how large or small, will produce some flow in a closed system.

For a given system resistance curve, the flow produced by any pump is determined by the intersection of the pump curve with the system resistance curve since only at this point is operating equilibrium possible. For each combination of system and pump, one and only one such intersection exists. Consequently, whether a pump curve is stable or unstable is of no consequence. This is illustrated in Fig. 3 – 1.

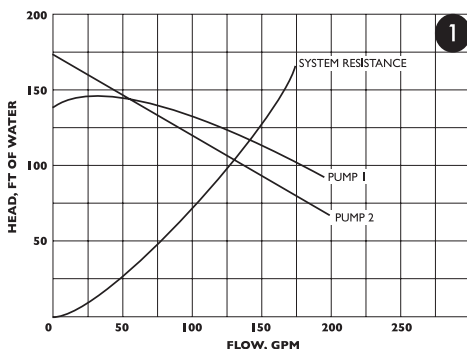

Fig. 3-1

5.

Single Pump In Open System With Static Head

In an open system with static head, the resistance curve originates at zero flow and at the static head to be overcome. The flow is again given by the intersection of system resistance and pump curves as illustrated for a stable curve in Fig. 3–2.

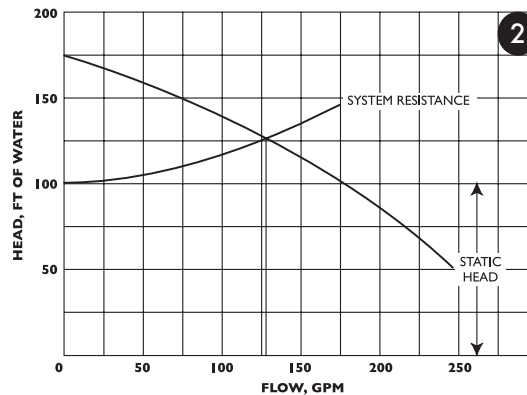

Fig. 3-2

It has been said that in an open system with static head a condition could exist where an unstable curve could cause the flow to “hunt” back and forth between two points since the system resistance curve intersects the pump curve twice, as shown in Fig. 3–3. The fallacy of this reasoning lies, in the fact that the pump used for the system in Fig. 3–3 already represents an improper selection in that it can never deliver any fluid at all. The shutoff head is lower than the static head. The explanation for this can be found in the manner in which a centrifugal pump develops its full pressure when the motor is started. The very important fact to remember here is that the shutoff head of the pump must theoretically always be at least equal to the static head.

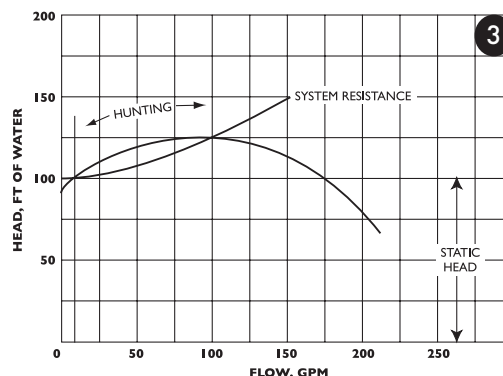

Fig. 3-3

From a practical point of view, the shutoff head should be 5 to 10 percent higher than the static head because the slightest reduction in pump head (such as that caused by possible impeller erosion or lower than anticipated motor speed or voltage) would again cause shutoff head to be lower than static head. If the pump is properly selected, there will be only one resistance curve intersection with the pump curve and definite, unchanging flow will be established, as shown in Fig. 3-4.

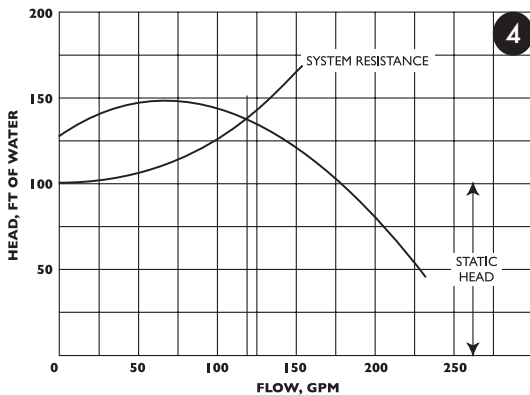

Fig. 3-4

Pumps Operating In Parallel

In more complex piping systems, two or more pumps may be arranged for parallel or series operation to meet a wide range of demand in the most economical manner. When demand drops, one or more pumps can be shut down, allowing the remaining pumps to operate at peak efficiency. Pumps operating in Parallel give multiple flow capacity against a common head. When pumps operate in series, performance is determined by adding heads at the same flow capacity. Pumps to be arranged in series or parallel require the use of a system curve in conjunction with the composite pump performance curves to evaluate their performance under various conditions.

It is sometimes heard that for multiple pumping the individual pumps used must be stable performance curves. Correctly designed installations will give trouble-free service with either type of curve.

The important thing to remember is that additional pumps can be started up only when their shutoff heads are higher than the head developed by the pumps already running.

If a system with fixed resistance (no throttling devices such

as modulating valves) is designed so that its head, with all pumps operating (maximum flow) is less than the shutoff head of any individual pump, the different pumps may be operated singly or in any combination, and any starting sequence will work. Fig. 3-5 shows an example consisting of two dissimilar unstable pumps operating on an open system with static head.

It is also important to realize that stable curves do not

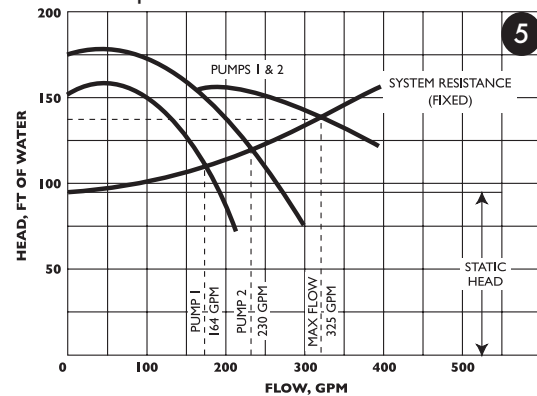

Fig. 3-5

guarantee successful parallel pumping by the mere fact that they are stable. Fig. 3-6 illustrates such a case. Two dissimilar pumps with stable curves are installed in a closed system with variable resistance (throttling may be affected by manually operated valves, for example).

With both pumps running, no benefit would be obtained from Pump I with the system resistance set to go through A, or any point between 0 and 100 GPM, for that matter. In fact, within that range, fluid from Pump 2 would flow backward through Pump I in spite of its running, because pressure available from Pump 2 would flow backward through Pump I in spite of its running, because pressure available from Pump 2 is greater than that developed by Pump I.

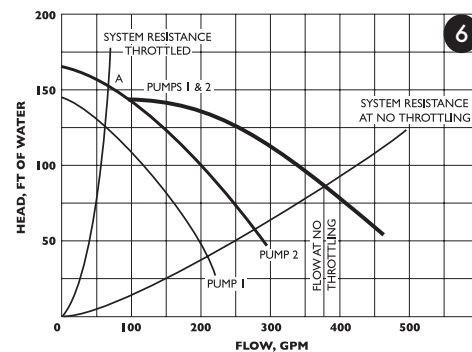

Fig. 3-6

Commercial Hydronic Application Information

In other words, Pump 2 overpowers Pump 1. For this reason, with Pump 2 running alone, Pump 1 should not be started unless Pump 2 operates to the right of the point where the curve of Pump 2 and the curve of Pumps 1 and 2 diverge (100 GPM) in Fig.3–6.

Parallel pumping is often an excellent way to obtain optimum operating conditions and to save energy. To be successful, however, systems and operating conditions must be understood. This applies to both stable and unstable pump curves.

Part IV – NPSH And Pump Cavitation

The net positive suction head (NPSH) is an expression of the minimum suction conditions required to prevent cavitation in a pump. NPSH can be thought of as the head corresponding to the difference between the actual absolute pressure at the inlet to the pump impeller and the fluid vapor pressure. An incorrect determination of NPSH can lead to reduced pump capacity and efficiency, severe operating problems and cavitation damage.

It is helpful to define separately two basic NPSH considerations; required NPSH (NPSHR) and available (NPSHA).

The required or minimum NPSH is dependent on the design of a particular pump and is determined by the manufacturer's testing of each pump model. The pump manufacturer can plot this required NPSH for a given pump model on performance curve and this value, expressed as feet of the liquid handled, is the pressure required to force a given flow through the suction piping into the impeller eye of the pump. Required NPSH can also be defined as the amount of pressure in excess of the vapor pressure required by a particular pump model to prevent the formation of vapor pockets or cavitation. Required NPSH, then, varies from one pump manufacturer to the next and from one manufacturer's model to another. The required NPSH for a particular pump model varies with capacity and rapidly increases in high capacities.

The available NPSH, on the other hand, is dependent on the piping system design as well as the actual location of the pump in that system. The NPSH available as a function of system piping design must always be greater than the NPSH required by the pump in that system. The NPSH available as a function of system piping design must always be greater

than the NPSH required by the pump in that system or noise and cavitation will result. The available NPSH can be altered to satisfy the NPSH required by the pump, if changes in the piping liquid supply level, etc., can be made. Increasing the available NPSH provides a safety margin against the potential for cavitation. The available NPSH is calculated by using the formula:

$$\text{NPSHA} = h_a \pm h_s - h_{vpa} - h_f$$

where:

- h_a = atmospheric pressure in feet absolute
- h_s "+" = suction head or positive pressure in a closed system, expressed in feet gauge
- h_s "-" = suction lift or negative pressure in a closed system, expressed in feet gauge
- h_{vpa} = vapor pressure of the fluid in feet absolute
- h_f = pipe friction in feet between pump suction and suction reference point.

Cavitation can be defined as the formation and subsequent collapse of vapor pockets in a liquid. Cavitation in a centrifugal pump begins to occur when the suction head is insufficient to maintain pressures above the vapor pressure. As the inlet pressure approaches the flash point, vapor pockets form bubbles on the underside of the impeller vane which collapse as they move into the high-pressure area along the outer edge of the impeller. Severe cavitation can cause pitting of the impeller surface and noise levels audible outside the pump.

The Taco pump performance curve below (Fig. 4–1) includes a plot of the required NPSH for a Taco Model 1506. If a pump capacity of 105 GPM is used as an example capacity requirement, reading vertically from that GPM rate shows a required NPSH of 4 feet. An available system NPSH greater than 4 feet would, therefore, be necessary to ensure satisfactory pump performance and operation.

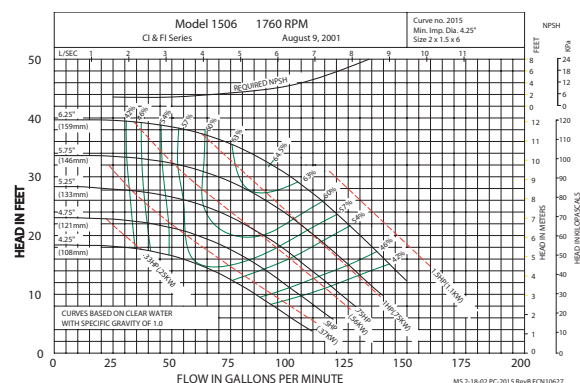

Fig. 4-1

FI Pump Materials of Construction

Description	Bronze Fitted		All Iron	
	Standard*	Optional	Standard	Optional
Casing	Cast Iron ASTM A48 CLASS 30		Cast Iron ASTM A48 CLASS 30A	
Impeller Silicon Bronze	Bronze ASTM B584-836 Bronze ASTM B584-875		Cast Iron ASTM A48 CLASS 30A	
Wear Ring	None	Bronze ASTM B584-932 SAE660	None	N/A
Shaft	Carbon Steel AISI 1045	Stainless Steel AISI 416	Carbon Steel AISI 1045	Stainless Steel AISI 416
Shaft Sleeve	Bronze SAE 660	Stainless Steel AISI 303	Stainless Steel AISI 303	N/A
Mechanical Seal: Stationary Seat	Ceramic	Ni-Resist Tungsten Carbide	Ceramic	Ni-Resist Tungsten Carbide
Rotating Face	Carbon		Carbon	
Elastomer	Ethylene Propylene	Viton	Ethylene Propylene	Viton
Spring	Stainless Steel		Stainless Steel	
Seal Flush Line	N/A	Copper	N/A	Stainless Steel

* Standard Pump Construction

Typical Specification

Furnish and install centrifugal end suction single stage pump(s) with capacities and characteristics as shown on the plans. Pumps shall be Taco model FI or approved equal.

Pump volute or casing shall be center-line discharge for positive air venting constructed of class 30 cast iron with integrally cast mounting feet to allow servicing without disturbing piping connections. The pump may be fitted with an optional replaceable bronze wear ring, drilled and tapped for gauge ports at both the suction and discharge connections and for drain port at the bottom of the casing.

The impeller shall be bronze and hydraulically balanced by either back vanes or balancing holes. The impeller shall be dynamically balanced to ANSI Grade G6.3 and shall be fitted to the shaft with a key. The pump shall incorporate a dry shaft design to prevent the circulating fluid from contacting the shaft. The pump shaft shall be high tensile alloy steel with replaceable bronze (stainless steel) shaft sleeve.

The cast iron pump bearing housing shall have heavy duty permanently lubricated sealed for life ball bearings, replaceable without disturbing the piping connections, and shall have a foot support at the driver end.

The pump shall have a self flushing seal design or a positive external seal flushing line. Pump may be furnished with a seal flush line and a Purocell #900 replaceable cartridge filter with shut-off isolation valve installed in the seal flushing line. The filter shall have the ability to remove particles down to five microns in size.

The pump seal shall be EPT Ceramic rated to 250° F.

The base shall be made of structural steel. The base shall also include an integral drain pan. A flexible coupler suitable for both across the line starting applications as well as variable torque loads associated with variable frequency drives, shall connect the pump to the motor and shall be covered by a coupler guard. Contractor shall level and grout each pump according to the manufacturers recommendations to insure proper alignment prior to operation.

Commercial Hydronic Application Information

Pressure Temperature Ratings

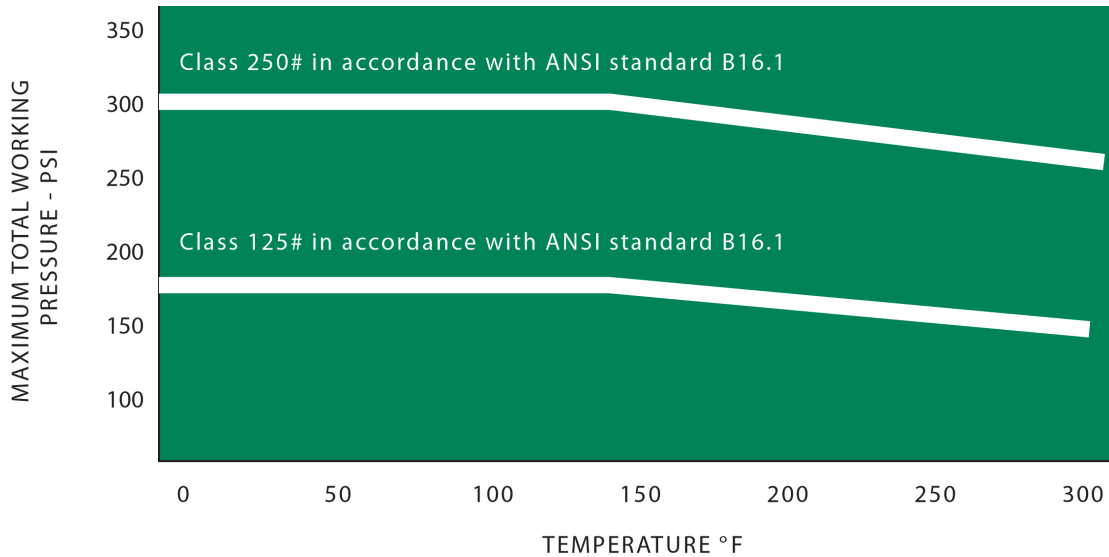

Operating Specifications

	Standard	Optional
Flange	Class 125*	Class 250*
Pressure	175 PSIG* 1210 KPA	300 PSIG* 2070 KPA
Temperature	250°F 120°C**	250°F 120°C**

* Per Pressure Temperature Ratings chart above.

Additional Options

Filters	Cuno 5 Micron
Separators	Kynar Cyclone Separator

** For operating temperatures above 250°F, a cooled flush is required and is recommended for temperatures above 225°F for optimum seal life. On closed systems, cooling is accomplished by inserting a small heat exchanger in the flush line to cool the seal flushing fluid.

FI Series Performance Field 1160 RPM

Curves also available on TacoNet.

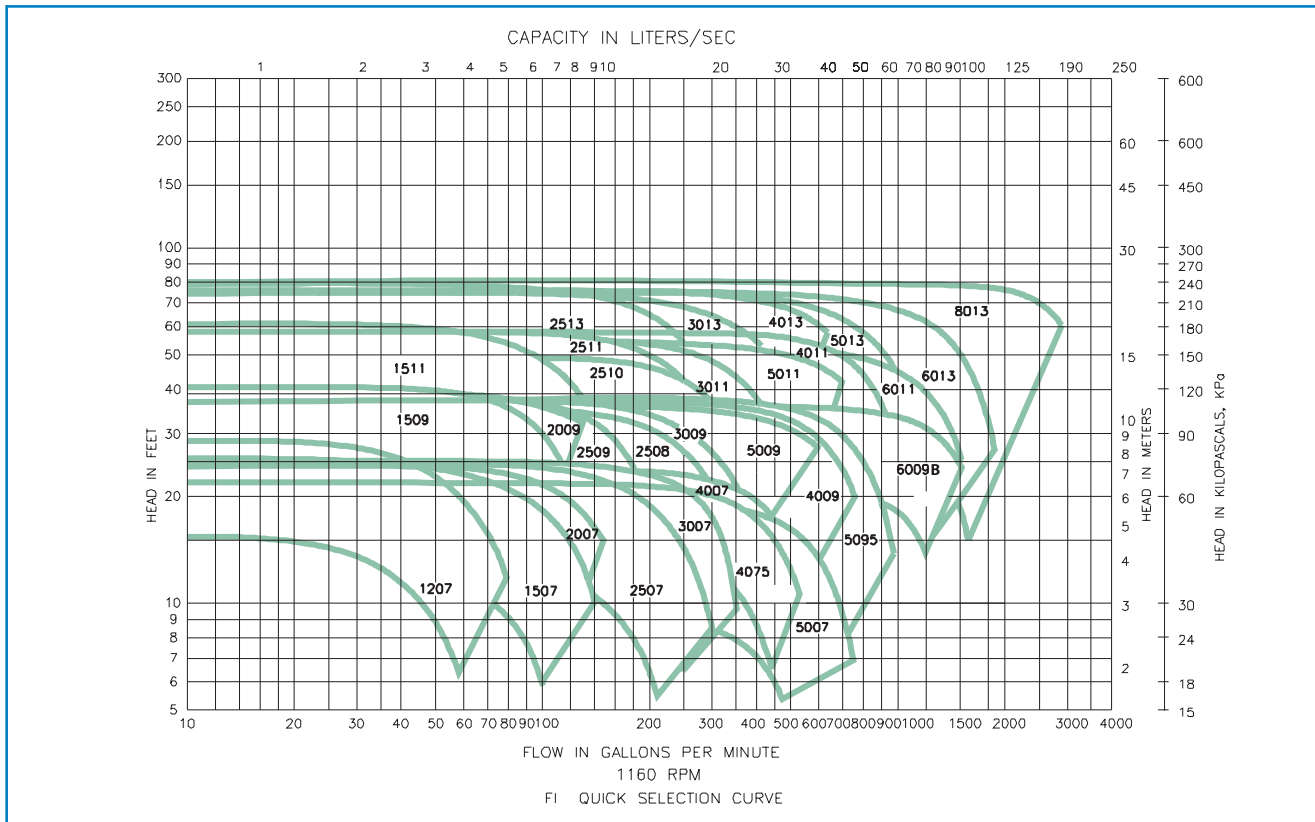

FI Series Performance Field 1760 RPM

Curves also available on TacoNet.

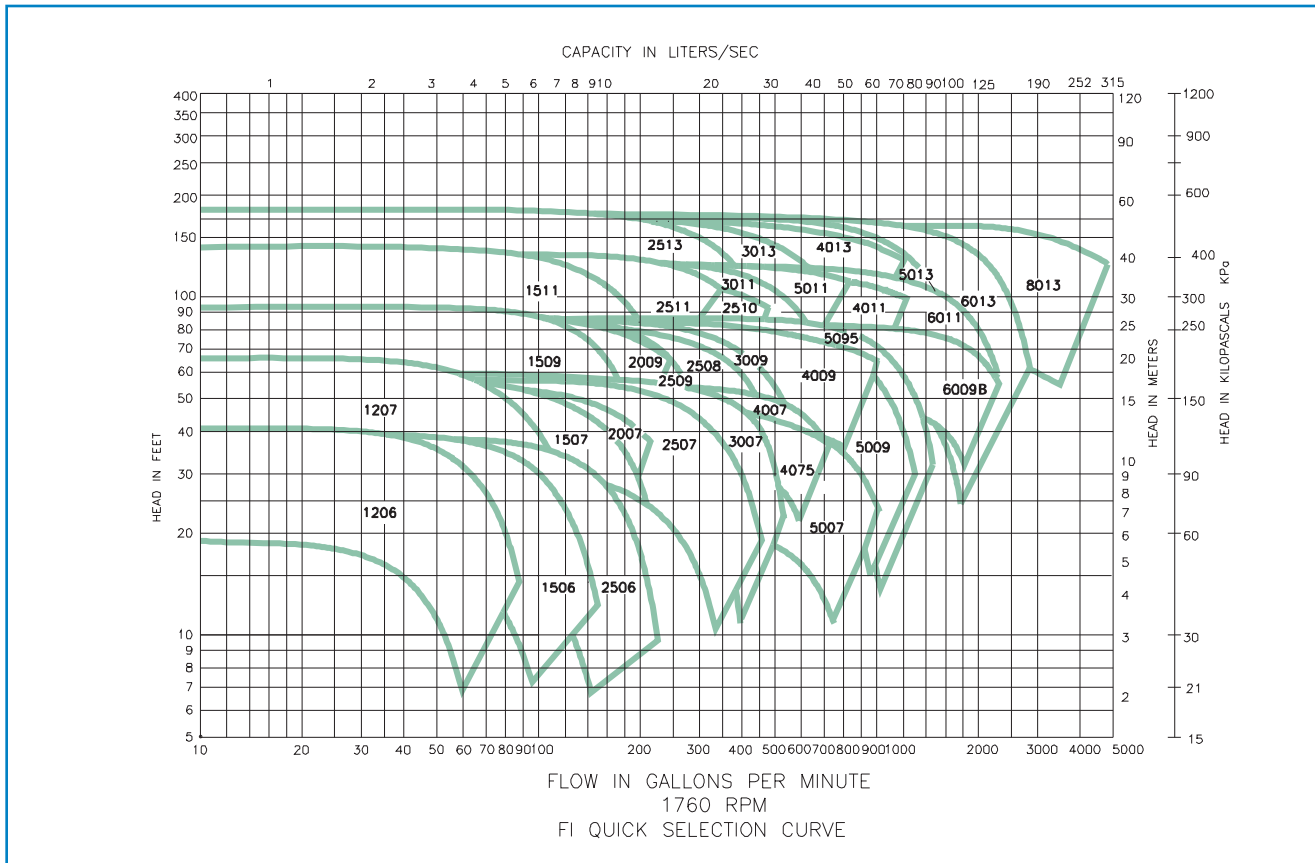

FI Series Performance Field 3500 RPM

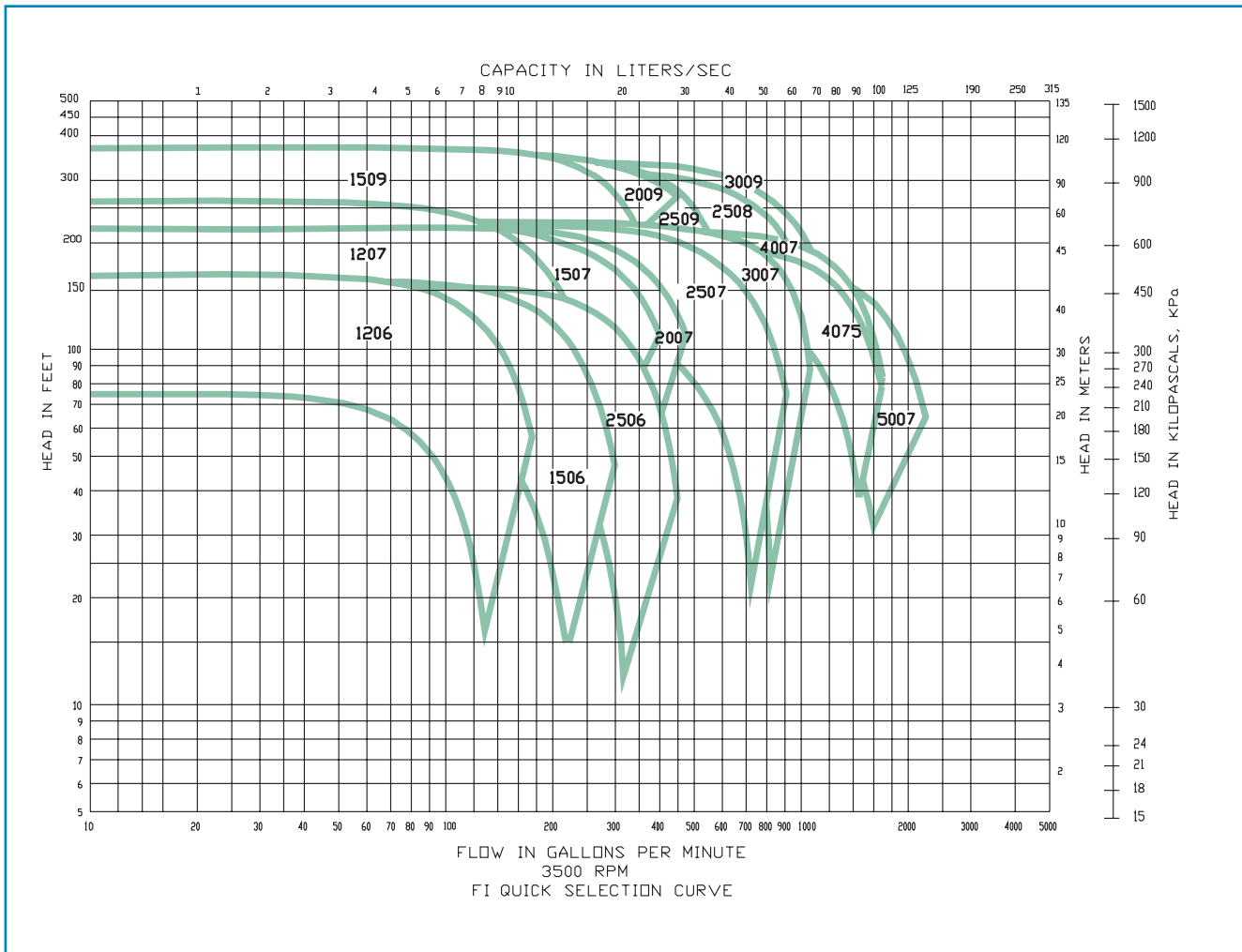

Curves also available on TacoNet®.

FI Series – 6” Pump Dimensions Data

(Individual submittal data sheets available on www.taco-hvac.com)

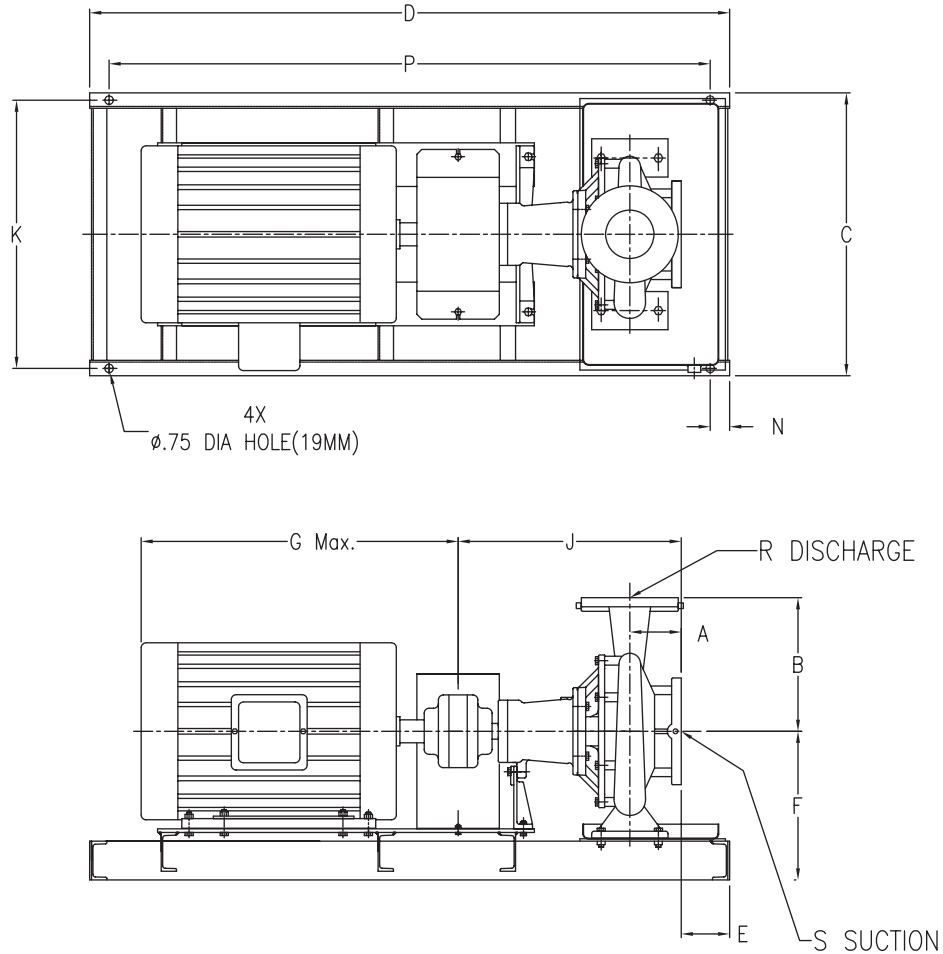

MODEL NO.	CONN. S X R	MOTOR FRAME SIZE	H.P. FOR 3 PHASE TEFC MOTORS		REF. BEARING FRAME SIZE	125# (860kpa) PRESS. CLASS										250# (1720kpa) PRESS. CLASS				
			1160	1760		A	B	C	D	E	F	G MAX.	J	K	N	P	A	B	E	J
			1/2&3/4	3500																
FI 1206	2 X 1 1/4 (51 X 32MM) ⊙	56	1/2&3/4	H	3.75 (95MM)	6.25 (159MM)	14.17 (360MM)	30.0 (762MM)	.75 (19MM)	9.51 (242MM)	11.94(303MM)	16.98 (431MM)	12.67 (322MM)	2.00 (51MM)	26.0 (660MM)	4.00 (102MM)	6.50 (165MM)	.49 (12MM)	17.23 (438MM)	
		143T	1				14.17 (360MM)	35.0 (889MM)	1.48 (38MM)		11.94(303MM)		13.0(330MM)		12.67 (322MM)			31.0 (787MM)		1.22 (31MM)
		145T	2				14.17 (360MM)	35.0 (889MM)	1.48 (38MM)		11.94(303MM)		13.0(330MM)		12.67 (322MM)			31.0 (787MM)		1.22 (31MM)
		182T	3				14.17 (360MM)	35.0 (889MM)	1.48 (38MM)		11.94(303MM)		13.0(330MM)		12.67 (322MM)			31.0 (787MM)		1.22 (31MM)
		184T	5				14.17 (360MM)	35.0 (889MM)	1.48 (38MM)		11.94(303MM)		13.0(330MM)		12.67 (322MM)			31.0 (787MM)		1.22 (31MM)
213T	7 1/2	14.17 (360MM)	35.0 (889MM)	1.48 (38MM)	11.94(303MM)	13.0(330MM)	12.67 (322MM)	31.0 (787MM)	1.22 (31MM)											
FI 1506	2 1/2X 1 1/2 (64 X 38MM)	56	1/2&3/4	H	3.75 (95MM)	7.25 (184MM)	14.17 (360MM)	30.0 (762MM)	.75 (19MM)	9.51 (242MM)	11.94(303MM)	17.02 (432MM)	12.67 (322MM)	2.00 (51MM)	26.0 (660MM)	4.06 (103MM)	7.50 (191MM)	.44 (11MM)	17.33 (440MM)	
		143T	1				14.17 (360MM)	35.0 (889MM)	1.48 (38MM)		11.94(303MM)		13.0(330MM)		12.67 (322MM)			31.0 (787MM)		1.16 (29MM)
		145T	2				14.17 (360MM)	35.0 (889MM)	1.48 (38MM)		11.94(303MM)		13.0(330MM)		12.67 (322MM)			31.0 (787MM)		1.16 (29MM)
		184T	5				14.17 (360MM)	35.0 (889MM)	1.48 (38MM)		11.94(303MM)		13.0(330MM)		12.67 (322MM)			31.0 (787MM)		1.16 (29MM)
		213T	7 1/2				14.17 (360MM)	35.0 (889MM)	1.48 (38MM)		11.94(303MM)		13.0(330MM)		12.67 (322MM)			31.0 (787MM)		1.16 (29MM)
215T	10	14.17 (360MM)	35.0 (889MM)	1.48 (38MM)	11.94(303MM)	13.0(330MM)	12.67 (322MM)	31.0 (787MM)	1.16 (29MM)											
FI 2506	3 X 2 1/2 (76 X 64MM)	56	3/4	H	3.74 (95MM)	7.25 (184MM)	14.17 (360MM)	32.0 (813MM)	1.06 (27MM)	10.61 (269MM)	11.94(303MM)	16.97 (431MM)	12.67 (322MM)	2.00 (51MM)	28.0 (711MM)	4.11 (104MM)	7.56 (192MM)	.69 (18MM)	17.34 (440MM)	
		143T	1				14.17 (360MM)	39.0 (991MM)	1.06 (27MM)		11.94(303MM)		13.0(330MM)		12.67 (322MM)			35.0 (889MM)		.56 (14MM)
		145T	1 1/2&2				14.17 (360MM)	39.0 (991MM)	1.06 (27MM)		11.94(303MM)		13.0(330MM)		12.67 (322MM)			35.0 (889MM)		.56 (14MM)
		184T	5				14.17 (360MM)	39.0 (991MM)	1.06 (27MM)		11.94(303MM)		13.0(330MM)		12.67 (322MM)			35.0 (889MM)		.56 (14MM)
		213T	7 1/2				14.17 (360MM)	39.0 (991MM)	1.06 (27MM)		11.94(303MM)		13.0(330MM)		12.67 (322MM)			35.0 (889MM)		.56 (14MM)
215T	10	14.17 (360MM)	39.0 (991MM)	1.06 (27MM)	11.94(303MM)	13.0(330MM)	12.67 (322MM)	35.0 (889MM)	.56 (14MM)											
254T	15	14.17 (360MM)	39.0 (991MM)	1.06 (27MM)	11.94(303MM)	13.0(330MM)	12.67 (322MM)	35.0 (889MM)	.56 (14MM)											

FI Series – 13” Pump Dimensions Data

MODEL NO.	CONN. S X R	MOTOR FRAME SIZE	H.P. FOR 3 PHASE TEFC MOTORS 1160 1760 3500			REF. BEARING FRAME SIZE	125# (860kpa) PRESS. CLASS										250# (1720kpa) PRESS. CLASS				
							A	B	C	D	E	F	G	J	K	N	P	A	B	E	J
							MAX.														
FI 2513	3 X 2 1/2 (76 X 64MM)	184T	2			J	4.72(120MM)	12.25(311MM)	19.17(487MM)	52.0(1321MM)	1.54(39MM)	13.19(335MM)	16.56(421MM) 17.94(456MM) 18.19(462MM) 21.69(551MM) 23.19(589MM) 24.94(633MM)	23.47(596MM)	17.67(449MM)	2.00(51MM)	48.0(1219MM)	5.09(129MM)	12.54(319MM)	1.17(30MM)	23.84(605MM)
		213T	3	7 1/2																	
		215T	5	10																	
		254T	7 1/2	15																	
		256T		20																	
		284T		25																	
FI 3013	4 X 3 (102 X 76MM)	213T	3			J	4.72(120MM)	12.25(311MM)	19.17(487MM)	52.0(1321MM)	1.05(27MM)	14.15(359MM)	17.94(456MM) 18.19(462MM) 21.69(551MM) 23.19(589MM) 24.94(633MM) 25.06(637MM) 26.69(678MM)	23.5(597MM)	17.67(449MM)	2.00(51MM)	48.0(1219MM)	5.03(128MM)	12.63(321MM)	.74(19MM)	23.81(605MM)
		215T	5	10																	
		254T	7 1/2	15																	
		256T	10	20																	
		284T		25																	
		286T		30																	
FI 4013	5 X 4 (127 X 102MM)	184T	2			J	6.10(155MM)	14.00(356MM)	19.17(487MM)	52.0(1321MM)	-0.34(8.6MM)	14.03(356MM)	16.56(421MM) 17.94(456MM) 18.19(462MM) 21.69(551MM) 23.19(589MM) 24.94(633MM) 25.06(637MM) 26.69(678MM) 27.69(703MM)	25.14(639MM)	17.67(449MM)	2.00(51MM)	48.0(1219MM)	6.54(166MM)	14.44(367MM)	-0.77(20MM)	25.58(650MM)
		213T	3	7 1/2																	
		215T	5	10																	
		254T	7 1/2	15																	
		256T	10	20																	
		284T	15	25																	
		286T		30																	
		324T		40																	
		326T		50																	
FI 5013	6 X 5 (152 X 127MM)	215T	5			L	5.31(139MM)	16.00(406MM)	25.17(639MM)	53.0(1346MM)	1.48(38MM)	15.33(389MM)	18.19(462MM) 21.69(551MM) 23.19(589MM) 24.94(633MM) 25.06(637MM) 26.69(678MM) 27.69(703MM) 29.69(754MM)	25.84(656MM)	23.67(601MM)	2.00(51MM)	49.0(1245MM)	5.75(146MM)	16.44(418MM)	1.04(26MM)	26.28(669MM)
		254T	7 1/2																		
		256T	10	20																	
		284T	15	25																	
		286T	20	30																	
		324T		40																	
		326T		50																	
		364T		60																	
FI 6013	8 X 6 (203 X 152MM)	254T	7.5			L	6.10(155MM)	17.00(432MM)	25.17(639MM)	53.0(1346MM)	.94(24MM)	16.71(424MM)	21.69(551MM) 23.19(589MM) 24.94(633MM) 25.06(637MM) 26.69(678MM) 27.69(703MM)	26.87(682MM)	23.67(601MM)	2.00(51MM)	49.0(1245MM)	6.60(168MM)	17.44(443MM)	.44(11MM)	27.37(695MM)
		256T	10																		
		284T	15																		
		286T	20	30																	
		324T	25	40																	
		326T	30	50																	
		364T		60																	
		365T		75																	
		405T		100																	
		25.17(639MM)	64.0(1626MM)	1.63(41MM)																	
FI 8013	10 X 8 (254 X 203MM)	256T	10			N	10.00(254MM)	19.00(483MM)	25.17(639MM)	60.00(1524MM)	2.38(60MM)	16.59(421MM)	23.19(589MM) 24.94(633MM) 25.06(637MM) 26.69(678MM) 27.69(703MM) 29.69(754MM) 29.69(754MM) 34.0(864MM) 44.3(1125MM) 44.3(1125MM) 47.74(1213MM)	31.65(804MM)	23.67(601MM)	2.00(51MM)	56.00(1422MM)	10.68(271MM)	19.50(495MM)	1.69(43MM)	32.33(821MM)
		284T	15																		
		286T	20																		
		324T	25	40																	
		326T	30	50																	
		364T	40	60																	
		365T	50	75																	
		405T	60	100																	
		444T		125																	
		445T		150																	
		447T		200																	
25.17(639MM)	74.00(1880MM)	2.38(60MM)				70.00(1778MM)				1.69(43MM)											



Taco Inc., 1160 Cranston Street, Cranston, RI 02920 / (401) 942-8000 / Fax (401) 942-2360
Taco (Canada) Ltd., 8450 Lawson Road, Unit #3, Milton, Ontario L9T 0J8 / (905) 564-9422 / Fax (905) 564-9436
www.taco-hvac.com