



The Hot Water Management Experts

Modulating Vertical Boilers & Water Heaters



Models 504A thru 2004A
Category I with vertical vent

Models 503A thru 2003A
Models 2503 thru 4003
Category IV Venting

Up to **88.4%** thermal efficiency!

CSA Certified Lead Content
Less Than .25% Lead



Proudly Assembled in the U.S.A

Category I*—up to 84% efficiency

Category IV—up to 88.4% efficiency

Raypak's Next Generation Modulating Boiler

Time-honored technologies unite with cutting-edge advancements in Raypak's MVB® modulating vertical boiler. Never before has a vertical boiler provided both the installer and building owner such installation flexibility, ease-of-commissioning, reliability and long-term performance. Small space, not a problem. The MVB 503A thru 2003A has the smallest installed footprint of any vertical boiler, only 5.4 square feet. MVB models 2503 thru 4003 are just 11.7 square feet. Raypak's MVB is built with commercial-grade components and materials. From our structural steel base to our stainless steel flue wrapper, you can tell the MVB is built to last. It's easy to handle and install, but still user friendly to service. Our compact design fits through a 32" door opening making it the perfect choice for those hard to reach retrofit projects. Now is the perfect time to take a closer look at Raypak.

Flexibility

Small diameter vents and industry-leading vent length allowances afford greater vent location options, thus reducing wasted space. Vent versatility is further enhanced by the self-tuning combustion system which compensates for unusual chimney and vent configurations.

Category I* -CSA-certified up to 84% boiler and water heater models available (503A-2003A). Our category I solution is the perfect replacement for your retrofit applications. This reduces the installed cost by using existing category I venting or chimney. Installation couldn't be easier; all connections are on the back of the unit. Start-up is a snap, it's as close to plug-n-play as a boiler can get.

Category IV -CSA-certified 86.2% H, 87% WH thermal efficiency (503A-2003A) and 85% thermal efficiency (2503-4003) at full fire—the highest possible for non-condensing boilers (*Up to 88.4% at part load!*) When the job requires high efficiency, our category IV solution meets your needs.

At the heart of every Raypak MVB is a unique integral evaporator system - the first defense against harmful condensation. Raypak's evaporator system collects and re-evaporates condensate which may form during initial start-up or brief periods of cold-water operation, eliminating the need for a boiler condensate drain. This saves you money on installation costs as well as the inconvenience of dealing with multiple condensate drains.

True Modulation

Modulation is nothing new to Raypak, we have honed our gas modulation experience for over 65 years. The Raypak MVB will precisely track the heating load with its built-in Versa IC® Integrated Control platform, eliminating costly overshooting. Utilizing the latest technology for the blower-gas valve package, the optimum fuel-air ratio is maintained throughout the entire range of the load-tracking operation. Now with up to 7:1 turndown (503A thru 4003 Cat IV) ensures efficiency is maintained throughout the firing rate and actually increases during part load, right when you want it! The MVB automatically self-tunes to accommodate the widest range of gas supply pressures. The high quality integrated blower-gas valve is self-correcting and allows smooth operation with fluctuating gas supply pressures. The Raypak MVB is cutting edge technology with atmospheric simplicity.

Key Features

- 16 models from 500,000 to 4,000,000 BTUH
- Up to 84% efficiency (Cat. I*);
- Up to 88.4% efficiency (Cat. IV)
- 7" Color touch screen display
- No boiler condensate drain required (proprietary design)
- Lowest minimum required inlet water temperature (120°F)
- Modulating gas valve and burner, up to 7:1 (503A thru 4003 Cat. IV) turndown
- Multiple pump outputs - Boiler, System, and Indirect DHW.
- 0-10 VDC BMS Interface (setpoint or direct drive).
- Built-in cascade function for up to 4 boilers.
- Built-in outdoor reset functionality.
- Modbus BMS port.
- Engineered with precisely matched system components
- Small installed footprint design fits tight spaces and easily replaces larger boilers
- Indoor/outdoor construction
- Complete cabinet protects all controls and wiring
- Low NOx combustion system
- Suitable for altitudes up to 10,000 ft. (derate above 5,000 ft.)
- With all copper and bronze waterways (optional on some models), the MVB is available in boiler and water heater configurations
- Inline combustion air filter (MERV8)
- All water heaters are low lead (<.25%) certified.

*Category I with vertical vent, category III with horizontal venting and no extractor.

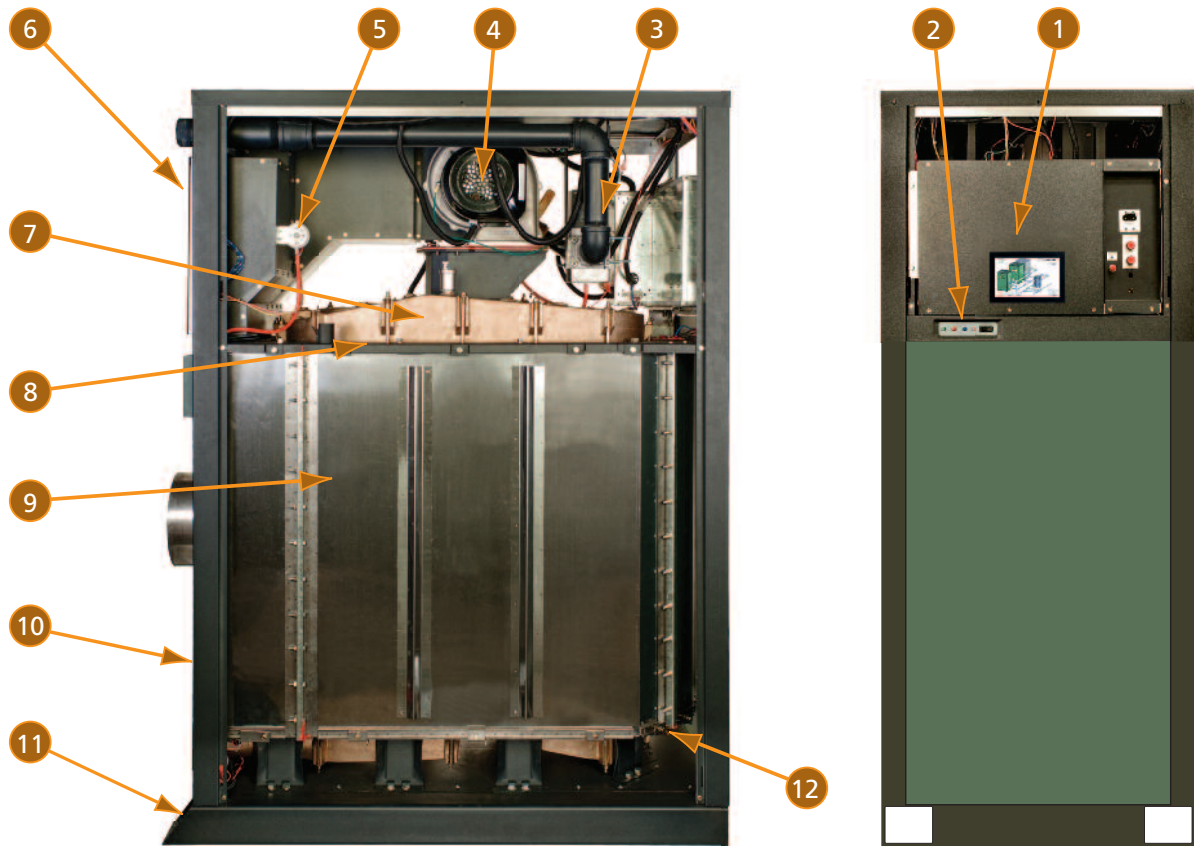

Models 2503 thru 4003

Features and Benefits

1. Control Interface

Large easy to read 7" color touch screen display. Will continuously monitor flame strength (μ a), sensor temps, BMS signal (0-10V), set points, DeltaT, all safety signals, full diagnostics and fault history for last 15 events. Everything you need from set-up to service is at your fingertips, all in one location.

1a. Versa IC Board (not shown)

The Versa IC, Integrated Control system is CSA listed and certified as a combined temperature, safety, and ignition control device. Easy front access to all field wiring. This includes outdoor sensor, DHW sensor, system alarm, Modbus BMS port and 0-10V DC input connections. Each unit comes factory equipped with cascade control capability. Simple, quick access daisy chain of up to 4 boilers, link to Raypak Temp Tracker Mod+ Hybrid Master control for up to 16.

1b. Low Voltage Wiring Connections (not shown)

Up front and easy to get to. Makes sensor wiring and external control wiring simple and clean.

1c. Control Panel (not shown)

Fully enclosed controls and wiring protect against damage or vandalism. Swing out cabinet design affords easy access to controls for installation and service

2. Status Lights and On/Off Switch

Easy to read and monitor boiler status. Colored lights alert maintenance personnel to power, call for heat, burner on and safety fault.

3. Gas Valve

Designed to work in perfect harmony with the air blower. The gas valve delivers the perfect fuel mix based on the amount of combustion air being supplied. The Euro designed gas valve provides smooth light off and precise flame modulation with up to 7:1 turndown (503A thru 4003 Cat. IV).

4. Combustion Air Blower

Cast aluminum blower housing, non-sparking construction. Precise PWM speed input allows for instantaneous response to the Versa IC control output. No blower lag associated with real time water temperature sensing.

5. Vent Pressure Switch

Monitors vent pressure and provides safe shut down if back pressure is excessive.

6. Air Filter

Every MVB comes standard with a rear access, easy to service Merv 8 media, combustion air filter.

7. Rugged Cast Headers

Bronze headers standard on water heater models. Cast-iron standard on boiler models 503A-2004A, with bronze headers optional. Bronze headers are standard on all models 2503 thru 4003.

8. Tube Sheet Construction

Eliminates the repair & maintenance problems associated with rolled-tube construction. Easy, cost-effective component replacement.

9. Vertical Heat Exchanger

Cylindrical, multi-pass heat exchanger for models 503A thru 2004A captures all radiant energy, eliminating the need for heavy refractory. Dual heat exchanger for models 2503 thru 4003.

10. Minimum Clearance Requirements

Only one inch of side clearance is required from combustible surfaces.

10a. Weather-Proof Jacket

Heavy gauge galvanized steel with a UV-resistant Polytuf powder coat finish is impervious to weather and corrosion. Raypak has one of the finest, top-of-the-line powder coat systems on the west coast regardless of industry. We laugh at a 1000 hour salt spray test. Independent test documentation available upon request.

11. Easy Rigging

Steel base allows for forklift/pallet jack use. Models 2503 thru 4003 have factory mounted rigging eyelets for hoist and crane connections.

12. Drain Valves

Two drain valves are located at the bottom of the heat exchanger. This allows for complete winterizing and drainage of the heater. Connects to a standard garden hose.



**Models
503A thru 2003A
504A thru 2004A**

503A thru 2003A 504A thru 2004A

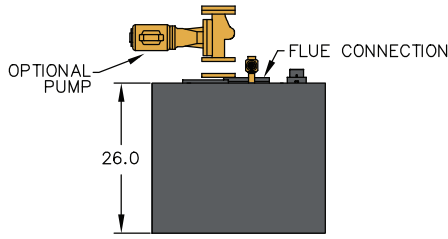

TOP VIEW

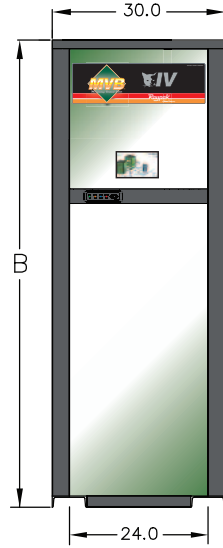

FRONT VIEW

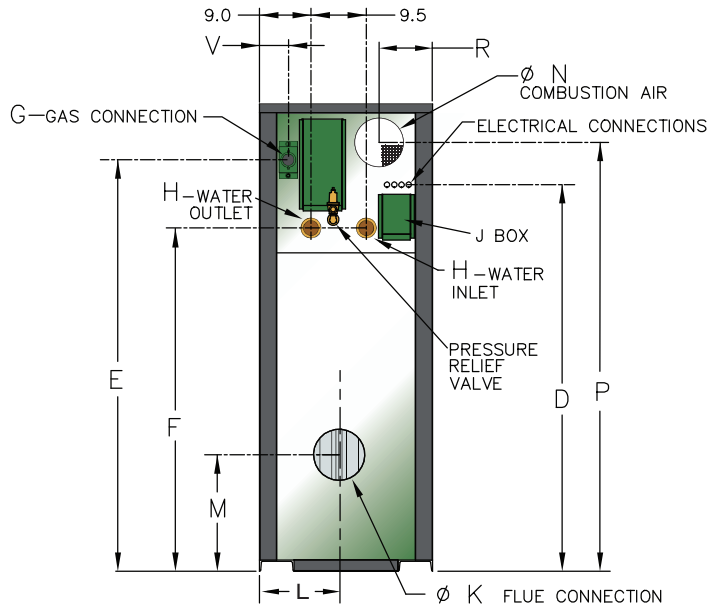

REAR VIEW

PHYSICAL DATA	Models		Dimensions (inches)														Shipping Weight (lbs.)	Amps [‡]	
	MVB Cat. I*	MVB Cat. IV	B Ht.	D	E	F	G [†] NPT	H	K-Ø Cat. I*	K-Ø Cat. IV	L	M Cat. I*	M Cat. IV	N CA Ø	P	R			V
	504A	503A	43	32	35	23-3/4	1	2 NPT	8	6	13-3/4	14-1/8	14-1/2	6	35	6	2	600	12
	754A	753A	49	38	41	29-3/4	1	2 NPT	10	6	13-1/2	16	14-1/2	6	41	6	2	660	12
	1104A	1003A	55	44	47	35-3/4	1-1/4	2-1/2 NPT	10	6	13-1/2	16	14-1/2	6	48-1/2	6	2	720	12
	1504A	1253A	61	50	53	41-3/4	1-1/4	2-1/2 NPT	12	8	13-3/4	18-1/8	17-3/4	8	53	6	2	780	12
	-	1503A	67	56	59	47-3/4	1-1/4	2-1/2 NPT	-	8	13-3/4	-	17-3/4	8	59	6	2	840	12
	2004A	1753A	75	62	65	53-3/4	2	2-1/2 NPT	14	8	13-1/2	20-1/8	17-3/4	8	68	9	5	940	18
	-	2003A	81	68	71	59-3/4	2	2-1/2 NPT	-	8	13-3/4	-	17-1/2	8	74	9	5	1000	18
	-	2503	68-1/4	64	64-7/8	7-5/16	2-1/2	4" groove	-	10	-	-	26-3/4	10	N/A	N/A	4-13/16	1410	12
	-	3003	73-1/4	69	69-7/8	7-5/16	2-1/2	4" groove	-	10	-	-	29-1/4	10	N/A	N/A	4-13/16	1450	15
	-	3503	78-1/4	74	74-7/8	7-5/16	2-1/2	4" groove	-	12	-	-	31-3/4	12	N/A	N/A	4-13/16	1550	17
	-	4003	83-1/4	79	79-7/8	7-5/16	2-1/2	4" groove	-	12	-	-	34-1/4	12	N/A	N/A	4-13/16	1660	20

*Category I with vertical vent, category III with horizontal venting and no extractor.

[†]NPT shown is for Natural Gas. For Propane, NPT= 1" for 503/4 thru 2003/4 and 2-1/2" for 2503 thru 4003 all water heater/boiler sizes.

[‡]Current draw is for heater only. (Supply breaker must have a delayed trip.)

PHYSICAL DATA	Models		Dimensions (inches)	
	MVB Cat. I*	MVB Cat. IV	W*	X*
	-	2503	58.22	67.12
	-	3003	63.22	72.12
	-	3503	68.22	77.12
	-	4003	73.22	82.12

*Only one port is to be used. All three ports are shown for pictorial purposes.

2503 thru 4003

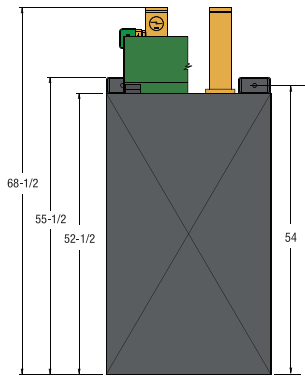

TOP VIEW

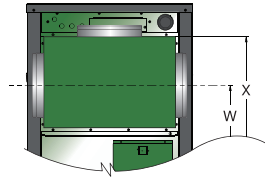

INDOOR w/ COMBUSTION AIR BOX

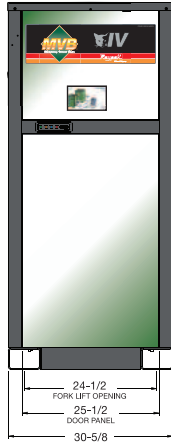

FRONT VIEW

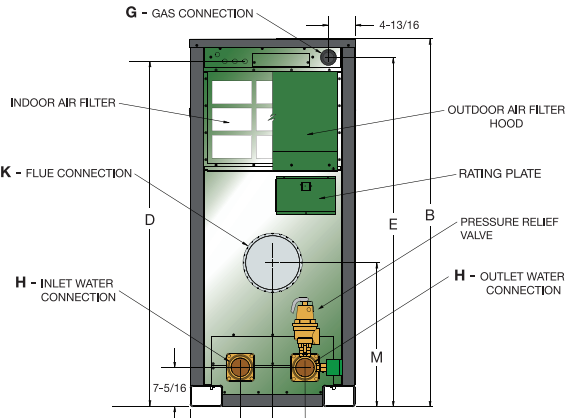

REAR VIEW



CLEARANCES			Heater Side	From Combustible Surfaces (min.)	For Service 503/4A thru 2003/4A	For Service 2503 thru 4003
	Floor*			0"	0"	0"
Rear			12"	24"	36"	36"
Right Side			1"	1"	24" **	24" **
Left Side			1"	1"	24" **	24" **
Top	Indoor		0"	10"	12"	12"
	Outdoor		Unobstructed	Unobstructed	Unobstructed	Unobstructed
Front			Open	24"	30"	30"
Vent Stack	Indoor		1"	1"	1"	1"
Vent Cap	Outdoor		12"	12"	12"	12"

*Do not install on carpeting

** One side 24" other 1" clearance.

Note: Local codes may require increased clearances

PUMP	MVB Model	Water Hardness					
		Soft		Medium		Hard	
		HP	Amps	HP	Amps	HP	Amps
	503A/504A	1/4	6	1/4	6	3/4	11
	753A/754A	1/4	6	1/2	7	3/4	11
	1003A/1104A	1/4	6	1/2	7	1	14
	1253A	1/2	7	1	14	1	14
	1503A/1504A	3/4	11	1	14	1	14
	1753A	1	14	1-1/2	15	1-1/2	15
	2003A/2004A	1-1/2	15	1-1/2	15	1-1/2	15
	2503	1-1/2	8.2	1-1/2	8.2	3	16
	3003	1-1/2	8.2	3	16	3	16
	3503	1-1/2	8.2	3	16	3	16
	4003	3	16	5	23	5	23

Note: Current draw (Amps) is for pump only

*Pump selections based on 75ft equivalent length of tubing

** At 230 VAC

Water hardness grains per gallon

Soft = 3-4 • Medium = 5-15 • Hard = 16-25

All components are contained inside the cabinet (except PRV), no external fans or valves to deal with.

Versa IC Boiler Control and On-Board Diagnostic Center

Versa IC merges safety, ignition and temperature control, outdoor reset and freeze protection, plus system monitoring, alarm and diagnostics, and BMS transmission all in one Integrated Control Platform. Easy front access to read, set up and trouble shoot on a 7" color touch screen. The entire package is CSA certified, and listed for each individual function.

Inlet and outlet sensors are factory-installed in boiler. Remote sensor for system included. BMS all point diagnostics transmission port. 0-10V DC set point input standard. Also can drive and monitor external motorized auxiliaries such as extractors and louvers. Additional connections for auxiliary functions, indirect DHW, and dry contact remote alarm relay are provided.



Outdoor Proven

Raypak is no stranger to the outdoor environment. Our cabinet design has been proven and perfected on our pool products. No guesswork here, just one tough boiler ready to take on jobs that others have to walk away from.

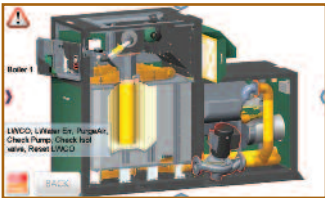

Diagnostic Information

Control Faults

- Low 24VAC
- Control Setup
- ID Card Fail
- Device Lost
- Device Error
- PIM Error

Safety Faults

- Sensor Failure - 6
- Condensate Full
- Vent Temp (PVC and Poly)
- Vent Block
- Manual Limit
- Auto Limit
- Water Flow
- Delta T Fault
- Low Water
- Low Gas
- High Gas
- Extra 1
- Options
- Mix Lock

Ignition Control Faults

- Ignition Lockout
- False Flame
- Ignition Failure
- Low HSI Current
- Blower Speed

Model	Venting Category †	Boilers			Water Heaters			Input Min.
		Input	Output	Efficiency	Input	Output	Efficiency	
503A	IV	500	431	86.2%	500	435	87%	71
753A	IV	750	647	86.2%	750	653	87%	108
1003A	IV	999	861	86.2%	999	869	87%	143
1253A	IV	1250	1078	86.2%	1250	1088	87%	179
1503A	IV	1500	1293	86.2%	1500	1305	87%	214
1753A	IV	1750	1508	86.2%	1750	1523	87%	250
2003A	IV	1999	1723	86.2%	1999	1739	87%	286
2503	IV	2501	2126	85%	2501	2126	85%	350
3003	IV	3000	2550	85%	3000	2550	85%	420
3503	IV	3500	2975	85%	3500	2975	85%	490
4003	IV	3999	3399	85%	4000	3400	85%	560
504A	I*	500	420	84%	500	415	83%	300
754A	I*	750	630	84%	750	623	83%	450
1104A	I*	1100	924	84%	1045	867	83%	660
1504A	I*	1500	1260	84%	1425	1183	83%	900
2004A	I*	1999	1679	84%	1900	1577	83%	1199

*Category I with vertical vent, category III with horizontal venting and no extractor.

†Category IV requires sealed vent with condensate drain. Category I uses conventional B vent.

Note: Ratings are for natural or propane gas and for elevations up to 5,000 ft. above sea level. For higher elevations, consult the factory.

Raypak Leadership in Boiler Management

The new modulating or stagefire VERSA IC fully integrates temperature control, ignition, safety, temperature safety and individual fault monitoring. Field upgradable. Raypak's unique Cold Water Protection control function is now built in; simply add the appropriate 3-way valve or variable speed pump. A Modbus communications port is standard for continuous monitoring, trending, and trouble shooting.

- Cascade up to 4 boilers
- Modbus RTU comm port standard
- All faults and interlocks monitored and reported in plain English
- Building Management System integration via optional gateways
 - BACnet MS/TP, BACnet IP, N2 Metasys or Modbus TCP
 - LONworks

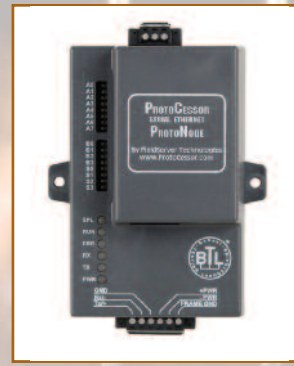

BACnet®, Metasys®
Modbus®
gateway module
(optional)

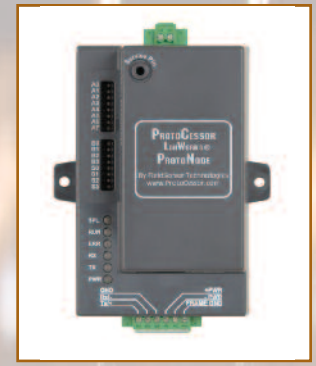

LONworks®
gateway module
(optional)

CATEGORY I* BOILERS (TYPE H)

MVB Model	Flow Rates						Pressure Drops					
	Minimum Flow			Maximum Flow			20°F		30°F		39°F	
	GPM	ΔP FT	ΔT °F	GPM	ΔP FT	ΔT °F	GPM	ΔP FT	GPM	ΔP FT	GPM	ΔP FT
504A	25	1.1	34	100	11.3	8	42	2.7	28	1.4	N/A	N/A
754A	32	1.8	39	100	13.8	13	63	6.0	42	2.9	32	1.8
1104A	47	4.3	39	113	18.6	16	92	13.3	62	6.7	47	4.3
1504A	65	8.4	39	113	22.2	22	N/A	N/A	84	13.3	65	8.4
2004A	86	16.7	39	113	27.2	30	N/A	N/A	112	26.9	86	16.7

CATEGORY I* WATER HEATERS (TYPE WH)

MVB Model	Flow Rates					
	Minimum Flow			Maximum Flow		
	GPM	ΔP FT	ΔT °F	GPM	ΔP FT	ΔT °F
504A	29	1.4	29	100	11.3	8
754A	43	2.9	29	100	13.8	13
1104A	60	6.7	29	113	18.6	16
1504A	82	13.3	29	113	22.2	21
2004A	94	27.2	34	113	27.2	28

CATEGORY IV BOILERS & WATER HEATERS (TYPE H & WH)

MVB Model	Flow Rates						Pressure Drops					
	Minimum Flow ‡			Maximum Flow			20°F		30°F		39°F	
	GPM	ΔP FT	ΔT °F	GPM	ΔP FT	ΔT °F	GPM	ΔP FT	GPM	ΔP FT	GPM	ΔP FT
503A	25 [†]	1.1	35	100	11.3	9	43	2.8	29	1.4	N/A	N/A
753A	33 [†]	1.9	39	100	13.8	13	65	6.4	43	3.1	33	1.9
1003A	44 [†]	3.7	39	113	18.6	15	86	12.0	57	6.0	44	3.8
1253A	55 [†]	6.2	39	113	22.2	19	108	20.9	72	10.2	55	6.5
1503A	66 [†]	9.5	39	113	25.5	23	N/A	N/A	86	16.0	66	10.0
1753A	77 [†]	13.4	39	113	27.2	27	N/A	N/A	100	22.5	77	14.0
2003A	88 [†]	15.2	39	116	30.2	30	N/A	N/A	115	32.0	88	19.8
2503	120 [†]	4.7	35	264	15.7	16	213	11.7	142	6.2	N/A	N/A
3003	131 [†]	6.3	39	264	23.1	19	255	21.7	170	10.3	131	6.3
3503	153 [†]	9.1	39	264	26.8	23	N/A	N/A	198	15.2	153	9.1
4003	174 [†]	13.5	39	264	33.5	26	N/A	N/A	227	23.7	174	13.5

*Category I with vertical vent, category III with horizontal venting and no extractor.
 † Use 30° column as minimum flow for hot water supply.

Boiler Only

Cascade up to 4 Boilers

The MVB comes standard with a built-in Cascading Boiler Control. No other controls to buy, just daisy chain the units together with a pair of standard 18 gauge copper wires (not supplied). Designate a Cascade Master Boiler and set all the other boilers as Followers. It's that simple! The MVB has built-in equal run-time rotation. This allows rotation of the starting boiler so all boilers in the system remain active and the run times remain equal on each unit.

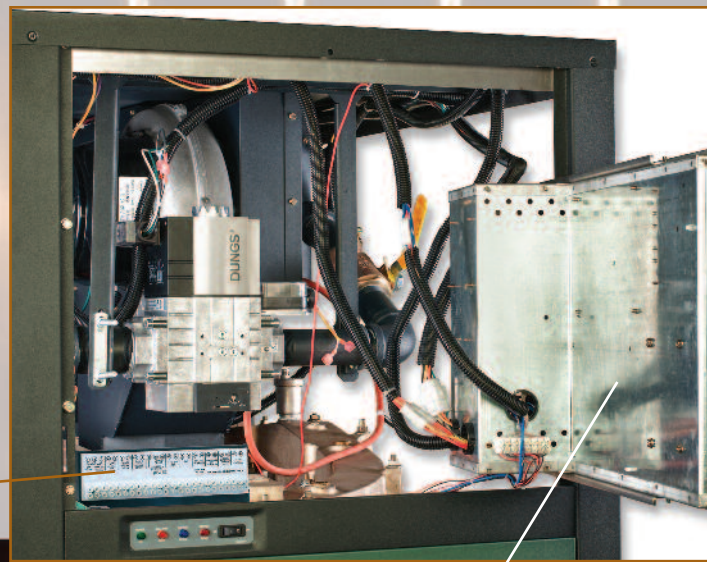

Low Voltage Wiring Terminal

Control panel swings open for easy control access.

Cat. I*	MVB Input (000)	Recovery Rates (GPH) - Boiler														
		10	20	30	40	50	60	70	80	90	100	110	120	130	140	150
84%	500	5,091	2,545	1,697	1,273	1,018	848	727	636	566	509	463	424	392	364	339
	750	7,636	3,818	2,545	1,909	1,527	1,273	1,091	955	848	764	694	636	587	545	509
	1100	11,200	5,600	3,733	2,800	2,240	1,867	1,600	1,400	1,244	1,120	1,018	933	862	800	747
	1500	15,273	7,636	5,091	3,818	3,055	2,545	2,182	1,909	1,697	1,527	1,388	1,273	1,175	1,091	1018
	1999	20,353	10,177	6,784	5,088	4,071	3,392	2,908	2,544	2,261	2,035	1,850	1,850	1,566	1,454	1,357

Cat. I*	MVB Input (000)	Recovery Rates (GPH) - Water Heater														
		10	20	30	40	50	60	70	80	90	100	110	120	130	140	150
83%	500	5,030	2,515	1,677	1,258	1,006	838	719	629	559	503	457	419	387	359	335
	750	7,545	3,773	2,515	1,886	1,509	1,258	1,078	943	838	755	686	629	580	539	503
	1045	10,513	5,257	3,504	2,628	2,103	1,752	1,502	1,314	1,168	1,051	956	876	809	751	701
	1425	14,336	7,168	4,779	3,584	2,867	2,389	2,048	1,792	1,593	1,434	1,303	1,195	1,103	1,024	956
	1900	19,115	9,558	6,372	4,779	3,823	3,186	2,731	2,389	2,124	1,912	1,738	1,593	1,470	1,365	1,274

Cat. IV	MVB Input (000)	Recovery Rates (GPH) - Water Heater														
		10	20	30	40	50	60	70	80	90	100	110	120	130	140	150
87%	500	5,273	2,636	1,758	1,318	1,055	879	753	659	586	527	479	439	406	377	352
	750	7,909	3,955	2,636	1,977	1,582	1,318	1,130	989	879	791	719	659	608	565	527
	999	10,535	5,267	3,512	2,634	2,107	1,756	1,505	1,317	1,171	1,053	958	878	810	752	702
	1250	13,182	6,591	4,394	3,295	2,636	2,197	1,883	1,648	1,465	1,318	1,198	1,098	1,014	942	879
	1500	15,818	7,909	5,273	3,955	3,164	2,636	2,260	1,977	1,758	1,582	1,438	1,318	1,217	1,130	1,055
85%	1750	18,455	9,227	6,152	4,614	3,691	3,076	2,636	2,307	2,051	1,845	1,678	1,538	1,420	1,318	1,230
	1999	21,080	10,540	7,027	5,270	4,216	3,513	3,011	2,635	2,342	2,108	1,916	1,757	1,622	1,506	1,405
	2501	25,768	12,884	8,589	6,442	5,154	4,295	3,681	3,221	2,863	2,577	2,343	2,147	1,982	1,841	1,718
	3000	30,909	15,455	10,303	7,727	6,182	5,152	4,416	3,864	3,434	3,091	2,810	2,576	2,378	2,208	2,061
	3500	36,061	18,030	12,020	9,015	7,212	6,010	5,152	4,508	4,007	3,606	3,278	3,005	2,774	2,576	2,404
4000	41,212	20,606	13,737	10,303	8,242	6,869	5,887	5,152	4,579	4,121	3,747	3,434	3,170	2,944	2,747	

Smallest Installed Footprint

The MVB's compact design allows for easy installation in the most challenging equipment rooms. It's easy to handle and install, but still user friendly to service. The MVB 503A thru 2003A has the smallest installed footprint of any vertical boiler, only 5.4 square feet. MVB models 2503 thru 4003 are just 11.7 square feet. The MVB contains all of its components to the inside of the cabinet, so there won't be any fans or valves hanging off the cabinet that need extra clearance. The compact design fits through a 32" door opening making it the perfect choice for those hard to reach retrofit projects.



Optional Equipment

Cold Water Solutions



Cold Water Start* – For applications that require reliable protection against harmful condensation caused by frequent, extended, cold water start-ups. Raypak's Cold Water Start protection system utilizes a proportional valve to bypass water from the boiler outlet to the inlet during start-up, when the system return water temperature is below the minimum acceptable level.

up, when the system return water temperature is below the minimum acceptable level.

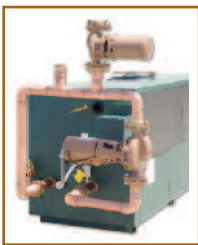

Cold Water Run – For applications requiring constant condensation protection. Raypak's Cold Water Run system utilizes a variable-speed pump to inject just the right amount of water from the main system loop into the boiler to maintain the optimum inlet temperature. This approach allows the full capacity of the boiler to be utilized to meet the system load, while at the same time continuously maintaining the optimum inlet water temperature to prevent condensation.

boiler to be utilized to meet the system load, while at the same time continuously maintaining the optimum inlet water temperature to prevent condensation.

Multi Boiler Solutions



Hybrid Control



BACnet BMS Link

TempTracker Mod+ Hybrid– Controls up to 16 Raypak boilers with PID logic.

Automatic or manually selectable lead-lag boiler operation. TempTracker Mod+ Hybrid monitors and displays supply water temperatures on all applications including outdoor temperature when outdoor reset mode is selected. Can also be used to control a mix of condensing and non condensing boilers using our Hybrid control algorithm. Now available with optional BACnet® MS/TP BMS link. (See Cat. # 5100.22)

*Not for use on potable water systems.



		Water Heaters (Type WH)	Boilers (Type H)	
HEAT EXCHANGER	ASME, National Board Registered, 160 PSI	● HLW Stamp ● H Stamp	N/A ●	
	Heat Exchanger Tubes	● Copper ○ Cupro Nickel	● ○	
	Bronze Headers	● Standard on all 2503 thru 4003	○	
	Cast Iron Headers	N/A	●	
	Pressure Relief Valve	● 60 PSI ● 125 PSI ○ 30, 45, 75, 150 PSI	○ ○ ○	
	Temperature & Pressure Gauge	●	●	
	Pump	● 120V, Single-Phase (503/4 thru 2003/4)	○	
JACKET	Indoor/Outdoor Construction	●	●	
	Vent Terminal	○ Outdoor ○ Through-The-Wall	○ ○	
	Fully-Enclosed Controls	●	●	
	Combustible Floor Rated	●	●	
OPERATING CONTROLS	120V Power Supply With 120V/24V Transformer (503/4 thru 2003/4) • 240V (2503 thru 4003)	●	●	
	On/Off Switch	●	●	
	Programmable Pump Time Delay, Single-Phase	● Included In Controller	●	
	Terminal Block Connections	● Enable / Disable ● External Interlocks ● 0-10 VDC Setpoint/Direct Drive Input	● ● ●	
	7" Capacitive color touch screen display	●	●	
	Status Display Lights (4)	●	●	
	Versa IC Control System (Cascade up to 4 heaters)	● (up to 7:1 Turndown) ● Outdoor Reset Sensor ● DHW Indirect Sensor	N/A N/A	○ ○ ●
	Multiple Boiler Controller	● TempTracker Mod+ Hybrid BACnet, Up To 16 boilers ● Multi-Mod Platinum (BACnet)	○ ○	○ ○
	SAFETIES	Hot Surface Ignition System	○ 1-Try (Standard On Cat. IV) ● 3-Try (Standard On Cat. I)	○ ○
		High/Low Gas Pressure Switches	● Hi Gas Standard on 2503 thru 4003	○
Blocked Vent And Air Pressure Switches		●	●	
High Limit Switch		● Manual Reset, Fixed (integral) ○ Additional Manual Reset, Adjustable ○ Additional Automatic Reset, Adjustable	○ ○ ○	
Low Water Cut-Off, 24V		● With Manual Reset And Test Buttons	○	
Flow Switch		●	●	
GAS TRAIN	Modulating Combination Gas Valve	●	●	
	Combustion Air Blower	●	●	
	TruSeal Direct-Vent Ready	●	●	
	Additional Safety Valve	● Motorized (Externally Mounted) ○ Solenoid (Externally Mounted)	○ ○	
OTHER	CSA-Certified Efficiency	● Cat. IV - 86.2% H, 87% WH At Full Fire (503A thru 2003A) ● 85%At Full Fire (2503 thru 4003) ● Cat. I - 83% - WH, 84% - H (See MBTUH Table)	● ● ●	
	Air Filter (Shipped Loose on models 503/4 thru 2003/4)	●	●	
	Alarm System	○	○	
	CSD-1 / GE GAP Control System	○	○	
	Low NOx	● Confirm Local Requirements	●	
	Cold Water Start	● Prevents Internal Condensation On Start-Up	○	
	Cold Water Run	● Prevents Condensation In Continuous Low-Temp Operation	○	

● ● = Standard ○ ○ = Optional

