



Catalog 214-15

RoofPak®
Applied Rooftop Systems

Heating & Cooling
Models RCS/RDT/RFS/RPS
15 to 140 Tons
R-410A Refrigerant



Introduction	3	Condenser Performance	37
A New Standard in Rooftop Flexibility	3	Furnace Performance	37
RPS/RFS Features and Options	4	System Operating Limits	38
RDT Features and Options	6	Coil Freeze Protection	38
Features and Options	8	Piping and Condensate Drainage	39
Unit Construction	8	Zone Sensor Placement	39
R-410A Refrigerant	8	Unit Wiring	39
Superior Efficiency	8	Condenser Coil Protection	39
Micro-Channel Condensers	9	Winter Shipment	39
Quiet Condenser Option	10	Unit Selection	40
Variable Speed Scroll Compressor	10	Selecting Unit Size to Satisfy Summer Design	40
Condensing Section	10	Selecting the Unit Heating System	40
Cooling Coil Section	11	Selecting Fans and Motors	41
Modulating Hot Gas Reheat	11	Calculating Unit Length	42
Supply and Return Fan Section	13	Physical Data	43
Variable Air Volume Control	13	Heating Capacity Data	47
Supply and Return Air Plenum	13	Gas Heat	47
Main Heat Section	14	208 Volts	48
Outside/Return Air Section	15	230, 460, and 575 Volts	49
DesignFlow Precision Ventilation Air Control System	17	Component Pressure Drops	56
Filter Section	17	Fan Performance Data—Supply Fans	60
Static Air Mixers	17	Fan Performance Data—Propeller Exhaust Fans	68
Sound Attenuators	17	Fan Performance Data—Return Fans	70
Humidifiers	17	Dimensional Data	72
Electrical	18	Section Options and Locations	72
Ultraviolet Lights	18	Electrical Knockout Locations	85
Variable Air Volume	19	Piping Entrance Locations	85
Variable Frequency Drives	19	Roof Curbs Dimensions	90
Airfoil Fans	20	Piping Data	94
Roof Curbs	20	Piping Connections, RFS/RCS Units	94
Intelligent Equipment™	20	Gas Piping Schematic	95
Microtech III Unit Controls	22	Recommended Clearances	96
Operating States	31	Service Clearance	96
Application Considerations	33	Cooling Coil, Heat and Supply Fan Service Clearance	96
General	33	Overhead Clearance	96
Unit Location	33	Ventilation Clearance	96
Split Units	33	Electrical Data	97
Curb Installation	33	Supply Power Wiring	101
Acoustics	34	Unit Weights	102
Economizer, Return Fan and Exhaust Fan Application	35	Base Unit Weights	103
Fan Isolation	35	Fan Motor Weights	103
Indoor Fan and Motor Heat, Blow-Through vs Draw-Through		Option Weights	103
Cooling	36	Roof Curb Weights	104
Altitude Adjustments	37	Engineering Guide Specification	105

A New Standard in Rooftop Flexibility

- 15 through 140 tons with the flexibility to provide 120 to 600 cfm/ton
- 100% make-up air, dehumidification, VAV or CV operation
- Modular construction and customized application flexibility
- Multiple fan, coil, filter and heat selections, and high efficiency compressor combinations
- Factory integrated and commissioned MicroTech® III advanced DDC control system
- Daikin's innovative Open Choices™ feature provides building automation system interoperability with BACnet® and LonWorks® communications capability
- Unit controllers are LonMark® 3.4 certified with an optional LonWorks communication module
- Durable, double wall construction with access doors on both sides of each section
- Blow-through configuration for high sensible cooling and quiet operation
- Draw-through configuration for high latent cooling or high humidity applications
- Modulating hot gas reheat for superior dehumidification
- DesignFlow™ ventilation control maintains proper amounts of outdoor air
- SuperMod™ furnace provides superior turndown and comfort control
- Return fans allow superior building pressure control
- Final filters for hospitals, labs or clean rooms
- Energy recovery (see catalog [CAT 220](#))
- Evaporative condenser (see catalog [CAT 219](#))
- Quiet condensing unit option
- Premium efficiency options
- All offered in a fully tested, factory packaged unit

Agency Listed



Nomenclature

RCS / R DT / RFS / R P S 070 D L A 2 S 5 0

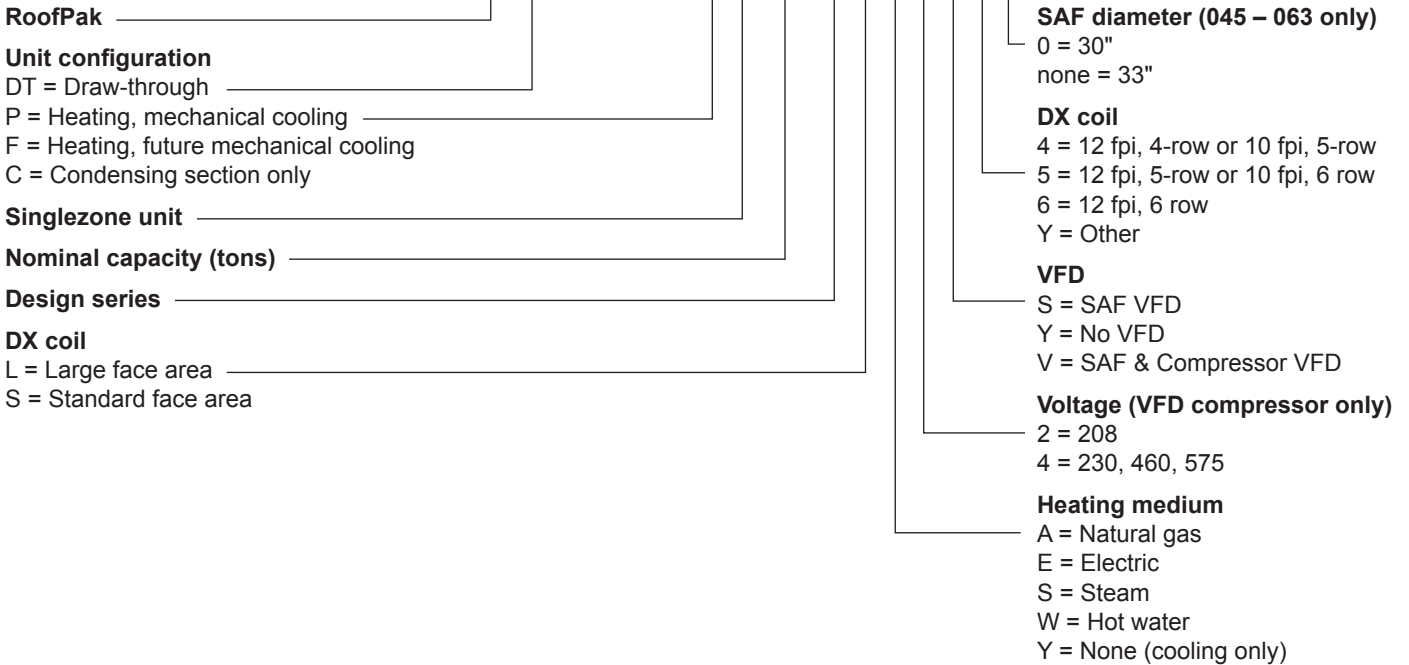

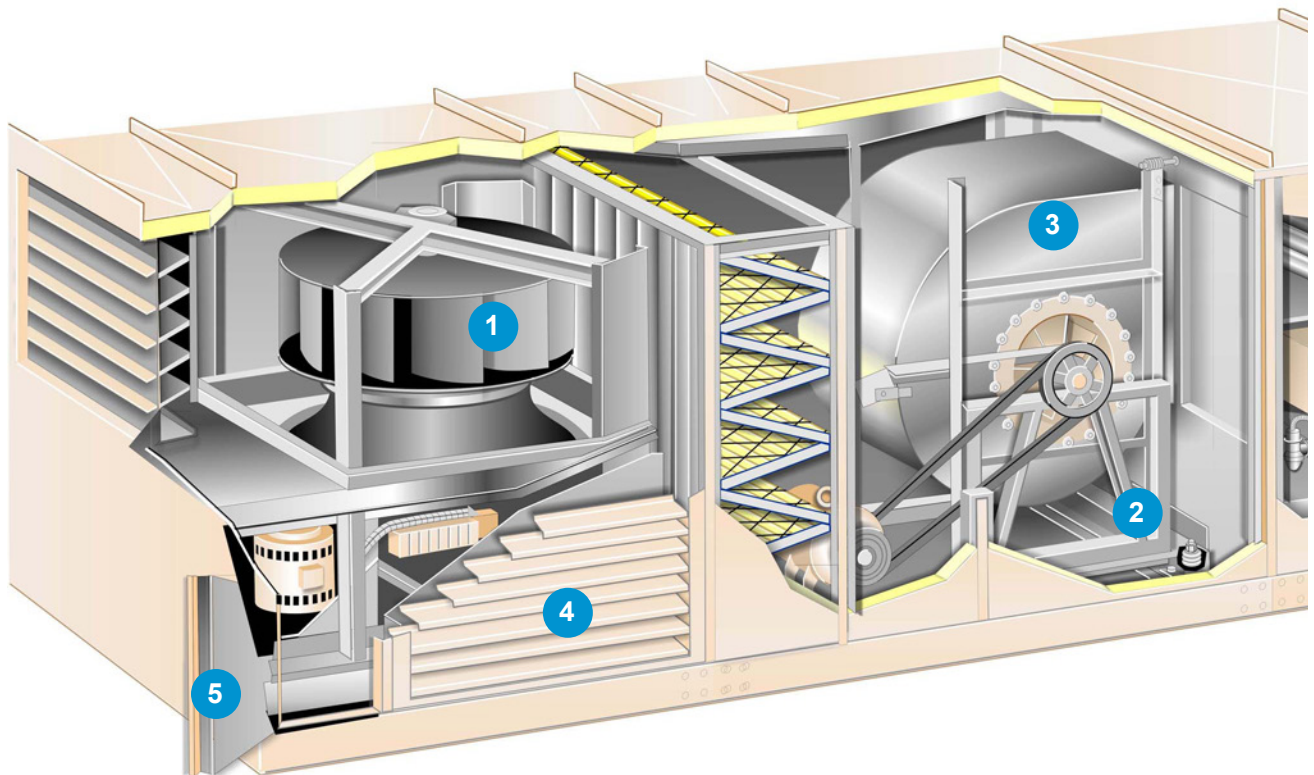

1 Return or Exhaust Fans

- Customize the unit to fit the application and return duct pressure drop
- Return fans provide better building pressure and ventilation control as return duct pressure drop increases
- Exhaust fans can save energy as return duct pressure drop requirements decrease



2 Factory-Mounted Variable Frequency Drives

- Control fan motor speed can lower fan operating costs and sound levels in VAV systems



3 Airfoil Fans

- More energy efficient and quieter than forward curved fans
- Double width, double inlet (DWDI) or single width, single inlet (SWSI) plenum fans



4 Economizer

- Outside air enters from both sides, improving mixing for better temperature control
- Patented DesignFlow Precision Outdoor Air Control System accurately measures and maintains outdoor air intake
- Patented UltraSeal™ low leak dampers minimize air leakage, reducing energy costs

5 Hinged Access Doors

- On both sides of every section for easy access to all components
- Single lever latch and door holders provide easy entry and support routine maintenance
- Double-wall construction protects insulation during maintenance

Blank Sections

- Available throughout unit to factory-mount air blenders, carbon or charcoal filters, sound attenuators (shown), humidifiers, or other specialty equipment
- Allow customization for maximum system performance and efficiency
- Can reduce design and installation costs



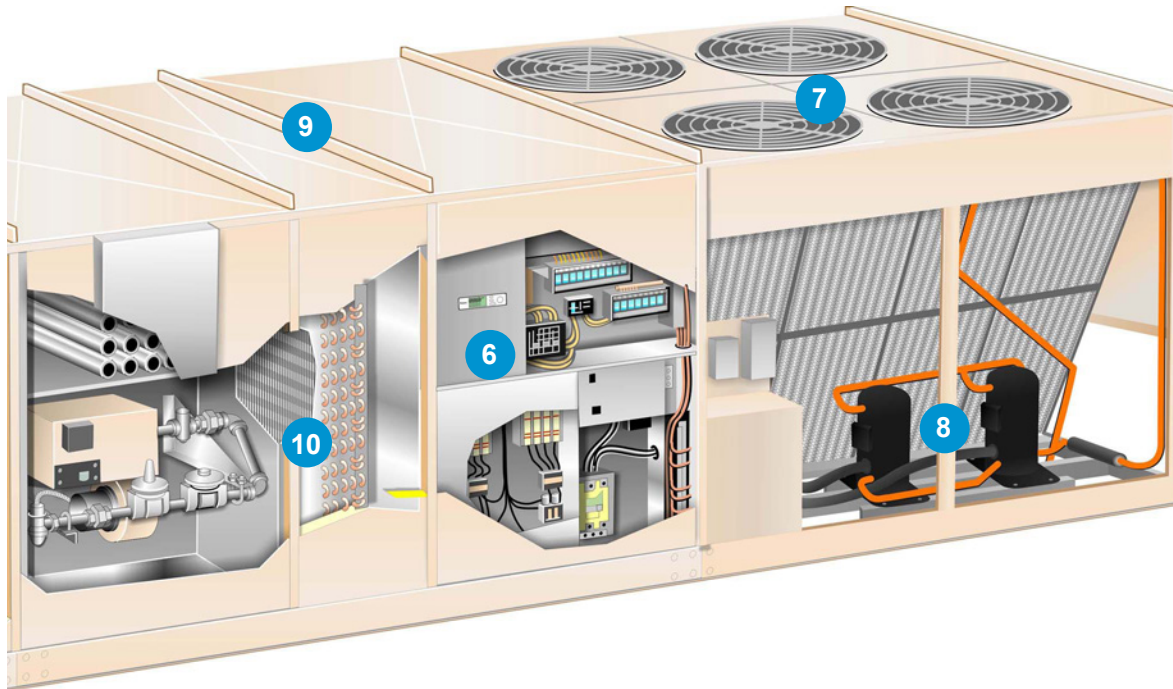

6 MicroTech III Control System

- Factory-installed and tested to help minimize costly field commissioning
- Open Choices feature for easy integration into the BAS of your choice using open, standard protocols such as BACnet or LonWorks communication
- Easily accessed for system diagnostics and adjustments via a keypad/display on unit
- Optionally add a remote keypad and display that is identical to the unit mounted user interface
- Optionally add the Intelligent Equipment™ control solution, which provides real-time data streams for benchmarking performance, monitoring system operations and implementing remote diagnostics and control



7 High Efficiency Condensing Section

- Open air design for unrestricted airflow and access to compressors and refrigerant piping
- Up to 6 steps of compressor capacity control, with hot gas bypass on each circuit, provides a stable discharge temperature and humidity control
- Microchannel condensers are more robust than traditional coils
- Premium efficiency option
- Quiet condensing unit option

8 Variable Speed Compressor

- Enhanced part load efficiency—lower operating costs
- Improved comfort—precise temperature and humidity control
- Reduced refrigerant fluctuations
- Superior acoustics at part load
- Minimized compressor cycling
- Reduced wear on compressors

9 Durable Construction

- Pre-painted exterior cabinet panels pass 1000-Hour ASTM B 117 Salt Spray Test for durability
- Capped seams prevent water leaks into the cabinet
- Cross-broken top panels help eliminate standing water
- Double-wall construction protects R-6.5 insulation and provides wipe clean surface
- Stainless steel, sloped drain pans help eliminate standing water

10 Blow-through or Draw-through Cooling Coils

- Customize your unit to fit the application and building load
- Blow-through provides greater sensible heat ratios and a colder unit leaving air temperature per ton
- Draw-through arrangement provides more dehumidification per ton

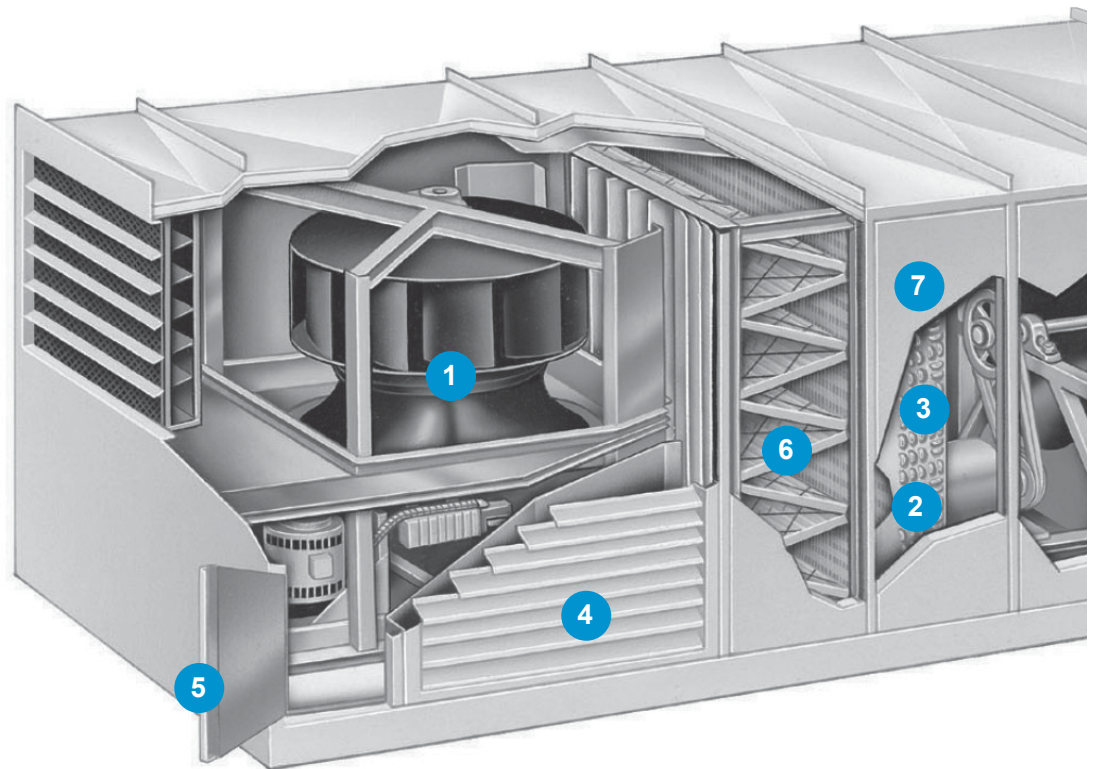

1 Return or Exhaust Fans

- Custom return duct pressure drop
- Exhaust fans typically save energy at low return duct pressure drops
- Return fans provide better building pressure and ventilation control as return duct pressure drop increases



2 Factory-Mounted Variable Frequency Drives

- Control fan motor speed can lower fan operating costs and sound levels in VAV systems



3 Airfoil Fans

- More energy efficient and quieter than forward curved fans
- Double width, double inlet (DWDI) or single width, single inlet (SWSI) plenum fans



4 Economizer

- Outside air enters from both sides, improving mixing for better temperature control
- DesignFlow™ Precision Ventilation Air Measurement System measures incoming air volume with an accuracy of ±5% for optimum control of minimum outdoor air intake and good IAQ
- Patented UltraSeal low leak dampers minimize air leakage, reducing energy costs

5 Hinged Access Doors

- On both sides of every section for easy access to all components
- Single lever latch and door holders provide easy entry and support routine maintenance
- Double-wall construction protects insulation during maintenance

6 Extended Face Area Filters

- 2" pleated or rigid cartridge
- 2" MERV 8 or MERV 13
- 12" MERV 11 or MERV 14 with prefilter

7 Draw-through System Design

- High latent cooling for make-up air systems or systems with high humidity loads

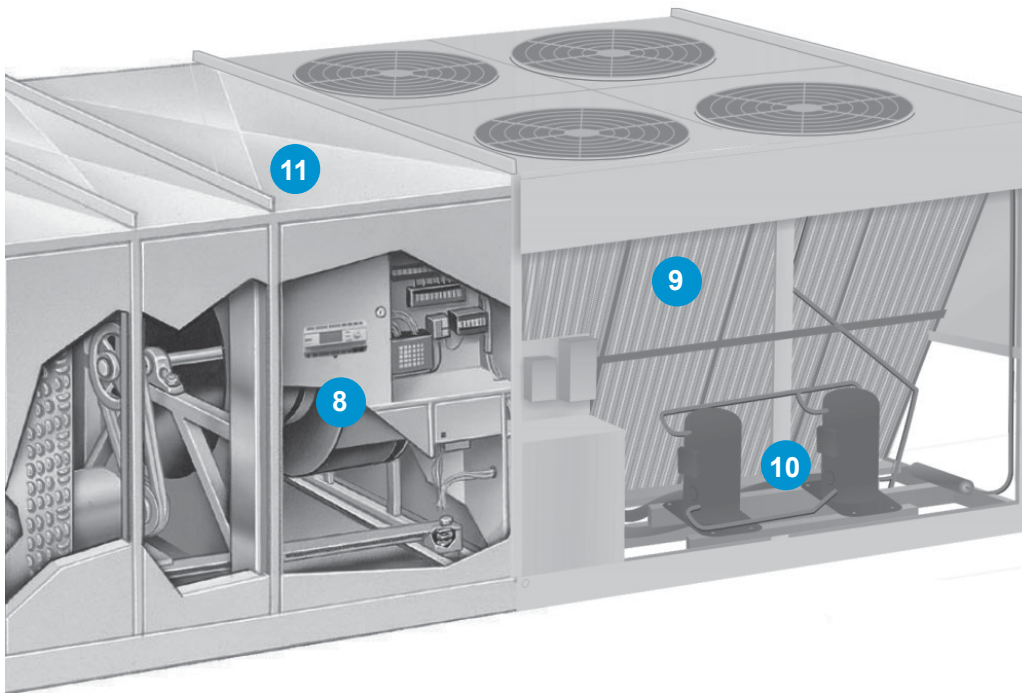

8 MicroTech III Control System

- Easily accessed for system diagnostics and adjustments via the unit controller keypad display
- Remote user interface option provides all functionality of unit-mounted interface
- Open Choices feature provides interoperability with BACnet or LonWorks communications for easy integration into your building automation system of choice
- Optionally add the Intelligent Equipment™ control solution, which provides real-time data streams for benchmarking performance, monitoring system operations and implementing remote diagnostics and control



9 Air Cooled Condenser

- Up to 6 steps of compressor capacity control—with hot gas bypass on each circuit—provides stable discharge temperature and humidity control
- Open air design for unrestricted airflow and access to compressors and refrigerant piping
- Micro-channel condensers are more robust than traditional coils
- Premium efficiency option
- Quiet condensing unit option

10 Variable Speed Compressor

- Enhanced part load efficiency—lower operating costs
- Improved comfort—precise temperature and humidity control
- Reduced refrigerant fluctuations
- Better acoustics at part load
- Minimized compressor cycling
- Reduced wear on compressors

11 Durable Construction

- Pre-painted exterior cabinet panels pass 1000-Hour ASTM B 117 Salt Spray Test for durability
- Capped seams prevent water leaks into the cabinet
- Cross-broken top panels help eliminate standing water
- Double-wall construction protects R-6.5 insulation and provides wipe clean surface
- Stainless steel, sloped drain pans help eliminate standing water

Daikin RoofPak systems are built to perform, with features and options that provide for lower installed costs, high energy efficiency, good indoor air quality, quiet operation, low cost maintenance and service, and longevity. Completed systems are factory tested and shipped with an ETL or ETL Canada Safety Listing.

Unit Construction

- Nominal unit cooling capacities from 15 to 140 tons
- Units up to 52-feet long can be shipped completely assembled
- Weather resistant cabinet design with standing top seams and cross-broken top panels to provide positive drainage
- Pre-painted exterior surfaces that withstand a minimum 1000-Hour salt spray test per ASTM B117
- Full size, double-wall hinged access doors on both sides of each section. All positive pressure door latches have a safety catch designed to prevent the door from opening rapidly if it is opened while the cabinet is under positive pressure
- Single lever latch mechanism and door holders on each access door
- Heavy-gauge galvanized steel unit base with formed recess to seat on roof curb gasket and provide positive weather-tight seal
- Heavy duty lifting brackets strategically placed for balanced cable or chain hook lifting
- Full double-wall construction is available throughout the unit to protect R-6.5 insulation, enhance performance and satisfy IAQ requirements
- Perforated liners are available in the plenum areas to enhance sound performance
- Available auxiliary blank sections provide the flexibility for factory-installed or field-installed specialty equipment
- Factory-mounted and factory-wired service lights with switch and outlet are available in each fan section
- Independent seismic certification to IBC 2006 and ASCE 7-05 requirements for most unit arrangements

Figure 1: Full Double-Wall Construction



R-410A Refrigerant

- R-410A refrigerant is an environmentally friendly HFC refrigerant with zero ozone depletion. Customers have no phase out and replacement concerns
- R-410A efficiency is excellent. Daikin R-410A rooftop units are available with EERs that exceed ASHRAE 90.12004. Alternative HFC refrigerants like R-407C inevitably force the unit to be significantly less efficient or more expensive, while R-410A reduces energy costs
- R-410A refrigerant is a blend, but the glide is negligible. This is not true for R-407C. If R-407C leaks, the remaining charge may not have a proper mix of components. R-410A does not have this problem so leaks are easier to repair
- Micro-channel condensers are used on all of these rooftop units. The condensers are much more robust and corrosion resistant than traditional copper tube and aluminum fin coils. Micro-channel condensers also have smaller diameter tubes so they require less refrigerant. Daikin micro-channel condensers last longer than competitive condensers and are perfect for LEED buildings

Superior Efficiency

- Energy costs continue to increase so better rooftop efficiency is extremely important to the building owner. Daikin offers several levels of efficiency including some of the most efficient units on the market
- Federal EPACT laws regulate rooftop minimum EERs up to 760 MBH and require ASHRAE 90.1-2010 compliance. Local codes regulate EERs above 760 MBH and either ASHRAE 90.1-2004 and ASHRAE 90.1-2010 are generally used
- Utility rebates often provide owners with tremendous incentives to purchase units with premium EERs that are well above ASHRAE 90.1 minimum values. Many utility rebates are based on CEE Tiers I and II EERs
- Daikin offers three levels of rooftop EERs to meet all of the above requirements as shown in the chart (Figure 2) and data (Table 1)

Table 1: Energy Efficiency Ratios

ASHRAE 90.1-2013		Premium Efficiency		ASHRAE 90.1-2004	
High Efficiency		Premium Efficiency		Standard Efficiency	
Model	EER	Model	EER	Model	EER
15	11.0	21	10.6	68	9.2
20	10.0	26	10.5	75	9.2
25	10.0	51	10.5	85	9.7
30	10.0	63	10.5	105	9.5
35	10.2	71	10.3	140	9.2
42	10.2	81	10.9		
45	10.5	91	10.8		
50	10.0	101	10.8		
61	10.0				
70	9.7				
79	9.7				
80	10.3				
90	9.9				
100	9.8				
110	10.5				
120	10.0				
125	9.7				
130	9.8				

- 1) These also have 90.1-2013 EERs
- 2) These also have Premium EERs
- 3) Based on AHRI 360
- 4) EER varies slightly depending on the supply fan and DX coil options. These EERs are based on the best fan and coil combination.

Figure 2: EER Options

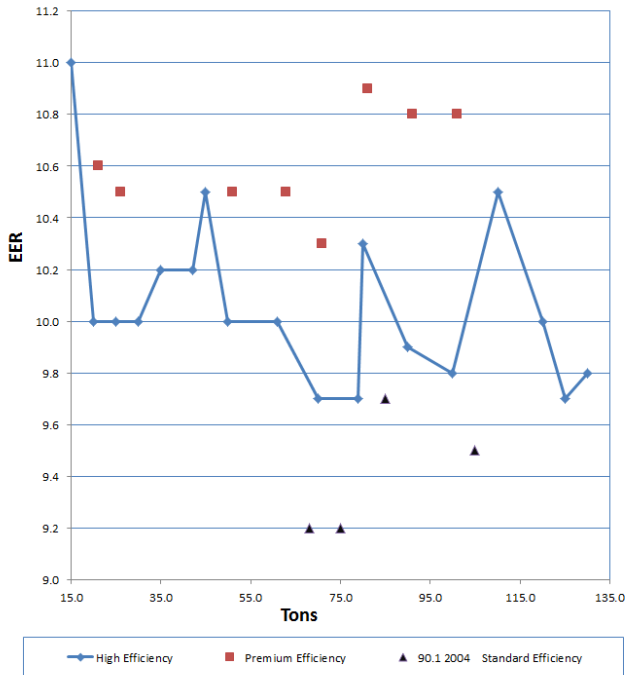

Micro-Channel Condensers

Micro-channel coils are an all-aluminum construction composed of:

1. Extended flat tubes (Figure 3) with many small flow channels.
 2. Flat fins (Figure 3) that are brazed to adjoining tubes.
 3. Two refrigerant manifold headers (Figure 3) that are arranged in a two-pass configuration (Figure 4).
- Flat tubes have better fluid-to-tube heat transfer. Therefore, micro-channel coils have more heat transfer per square foot than traditional coils and require much less refrigerant charge per ton of cooling
 - All aluminum construction eliminates galvanic corrosion associated with dissimilar metals. All aluminum coils are much more resistant to normal condenser corrosion in any location including the sea coast
 - Electrofin™ cooling option is recommended for seacoast or other corrosive applications and ambient environments
 - Aluminum is lighter than copper, so Daikin R-410A condensers are lighter than competitive condensers
 - Micro-channel coils were pioneered in the auto industry and one reason is their more robust construction. Fins are brazed between adjoining tubes so there are no exposed and vulnerable edges. Fin damage is therefore virtually eliminated

Figure 3: Supply and Return Manifolds

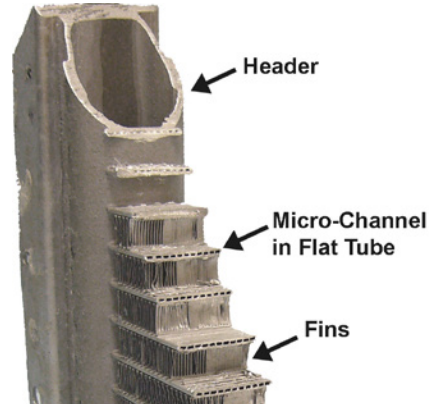

Figure 4: Typical 2-Pass Construction



Quiet Condenser Option

Reducing Noise for Sound Sensitive Applications

For many applications, low radiated sound is a critical factor in the selection and installation of air-cooled equipment. In response to the need for quieter units, Daikin offers a quiet condenser option for RoofPak™ applied rooftop systems. When this option is employed, sound power at the unit is reduced by an average of 7 dB when compared to standard units. The quiet condenser option reduces overall radiated sound power levels by about 6-8 dB depending on unit size. ASHRAE Fundamentals Chapter 7 defines a 5 dB reduction as “quieter” and a 10 dB reduction as “half as loud”.

This reduction in sound power can also impact where the unit can be located relative to the lot line. For example, if local code requires a maximum of 50 dB sound pressure at the lot line, the standard condenser must be located 250 feet from the lot line to comply. With Daikin quiet condensers, this distance is reduced to 120 feet.

Features and Benefits

Daikin quiet condensers are specially engineered to reduce radiated noise and improve condenser fan efficiency. Included with this option:

- Aerodynamic, airfoil, sickle-shaped blades and bell mouth orifices improve fan efficiency
- Each fan includes seven blades complete with serrated trailing edges and special blade tip to break up turbulence and reduce noise
- Individual compressor sound blankets are provided to reduce noise

Condensing Unit Performance

The use of the quiet condensers option has a nominal impact on unit performance as shown in [Table 2](#).

Variable Speed Scroll Compressor

Daikin units with variable speed inverter compressor engineered with fixed speed compressor/s in such a way that unit delivers only the required energy to satisfy space conditions and provides you with exceptional energy savings. It improves comfort through precise temperature and humidity control. Variable speed compressor enhanced energy efficiency and capable of providing modulation down to 15%, eliminates compressors cycling and reduces wear on compressor. It also provides superior acoustics at part load capacity.

Condensing Section

- Open design permits unrestricted condenser airflow, access to compressors, refrigeration components and piping, and access for roof maintenance
- Unique rail support system allows the roof deck and insulation to help block compressor noise from entering the building.
- High efficiency Copeland® scroll compressors
- Each refrigerant circuit is furnished with an accessible sightglass, filter drier, manual shutoff valve, high pressure switch, low pressure switch, liquid line solenoid valve, TXV and manual control circuit switch
- All units feature dual refrigeration circuits for redundancy and efficient capacity control
- Large face area micro-channel condenser coils
- Vertical air discharge minimizes noise
- Three-phase condenser fan motors eliminate reverse rotation failures
- Up to six steps of compressor capacity control, with hot gas bypass (on one or both circuits) provides for stable discharge temperature and humidity control
- Optional VFDs provide accurate head pressure control and allow mechanical cooling to 0°F ambient temperatures
- Cross wire PVC coated coil guards are available to protect the condensing section from vandals
- Recessed V-bank condenser coils have built-in hail damage protection

Table 2: Quiet Condenser Performance

Model	Performance Factor		Model	Performance Factor		Model	Performance Factor	
	MBH	Comp/kW		MBH	Comp/kW		MBH	Comp/kW
015D	0.99	1.02	050D	0.98	1.03	085D	0.98	1.09
016D	0.99	1.02	051D	0.97	1.06	090D	0.99	1.02
020D	0.98	1.03	062D	0.99	1.02	091D	0.99	1.03
021D	0.98	1.04	063D	0.99	1.02	100D	0.99	1.02
025D	0.98	1.04	068D	0.98	0.99	101D	0.99	1.04
026D	0.98	1.04	070D	0.99	1.03	105D	0.98	1.03
030D	1.00	1.03	071D	0.98	1.04	110D	0.98	1.03
031D	0.99	1.01	075D	0.99	1.02	120D	0.98	1.03
035D	0.99	1.01	079D	0.99	1.03	125D	0.98	1.03
042D	0.99	1.03	080D	0.98	1.03	130D	0.99	1.02
045D	0.99	1.03	081D	0.98	1.06	140D	0.99	1.02

NOTE: Approximate kW per condenser fan (varies slightly per unit) Standard fan = 1.05 Quiet fan = 0.75

Cooling Coil Section

- Large face area evaporator coils with high efficiency, enhanced copper tubing and aluminum fins, provide for low air pressure drop and high full and part load operating efficiencies
- All evaporator coils feature interlaced circuiting to keep the full face of the coil active and eliminate air temperature stratification
- Long-life painted, galvanized steel or stainless steel, sloped (1/8-in./ft. incline) drain pans. An intermediate drain pan in the coil bank helps to provide condensate removal without carryover
- 3, 4, or 5 row evaporator coils with 8, 10, or 12 fins/inch spacing allow a custom match to specific design loads. Multiple coil face areas allow units to be properly matched to wide ranging conditions from 100% outside air to high cfm comfort cooling applications

Figure 5: Extended Face Area Coils



Modulating Hot Gas Reheat

In a packaged rooftop system, hot refrigerant gas leaving the compressor can be channeled to a separate coil to reheat the air leaving the cooling coil, as pictured below. This reheat costs no energy and is an excellent way to optimize dehumidification.

For best performance, Daikin precisely controls or modulates the supply of the hot gas to the reheat coil. This modulation helps to maintain a constant, desired supply air temperature. Without it, supply air temperatures can vary significantly as the unit's compressors cycle ON and OFF. See [Figure 6](#).

Typical Applications

- 100% Outdoor Air units providing neutral air for terminal unit systems, including fan coils and VRV DX systems, and supplying spaces with large ventilation requirements, such as hospitals and laboratories. See [Figure 8](#)
- Large single-zone applications, especially with dense occupancy, such as churches, theaters and gyms. These systems cannot dehumidify at part-load without reheat because DX coil latent air temperatures rise at part load. See [Figure 9](#)

Features

- MicroTech III controls with integrated compressor and reheat control. Reheat is automatically energized whenever dehumidification is needed. Modulating valves on both the condenser coil and reheat coil for more precise modulation
- Enhancements on RoofPak systems that allow +/-1 degree of supply air temperature control. These include an averaging discharge sensor and VFDs that modulate condenser fan speed and maintain a constant head pressure
- Microchannel reheat and condenser coils, which are more robust than traditional fin-tube coils and more resistant to corrosion. Flat tubes and microchannel flow allow more heat transfer per square foot of coil. And, because microchannel coils require far less charge, refrigeration service is less expensive. No receivers or oil flushing cycles are required and subcooling is always provided

Benefits

- Effective humidity control without using additional energy to reheat the cooled air. Without hot gas reheat, a separate heating system would be required to reheat the cooled, dehumidified air to the desired level, which often violates ASHRAE 90.1-2007 guidelines. Or, higher humidity levels would have to be accepted in the conditioned space
- More consistent humidity and temperature control in the conditioned space. Through compressor control, Daikin systems maintain a constant dew point in the air leaving the cooling coil (beware of inferior competitive alternatives). By modulating the hot gas to the reheat coil, Daikin systems are able to maintain a constant leaving air temperature. See [Figure 6](#)

Figure 6: Dual 2-way Valve Refrigerations Schematic

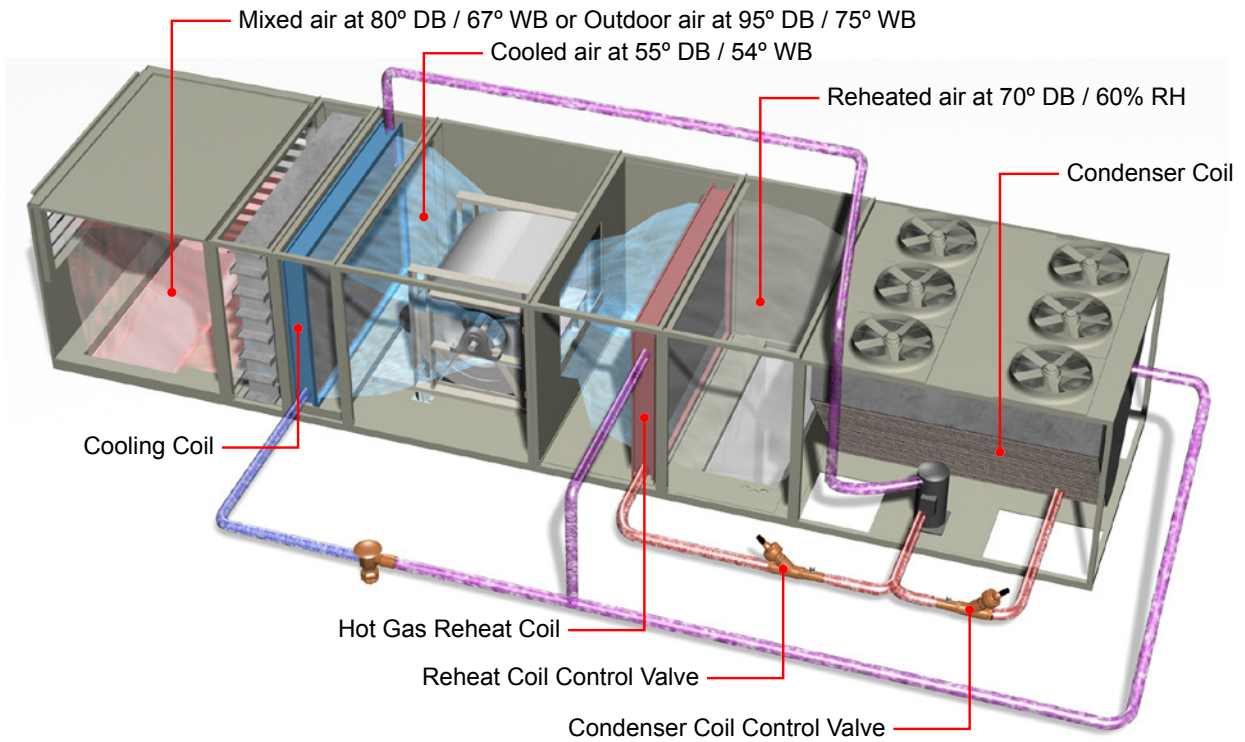

Figure 7: Modulation prevents excessive variation in leaving air temperature (LAT) and allows $\pm 1^\circ$ LAT control

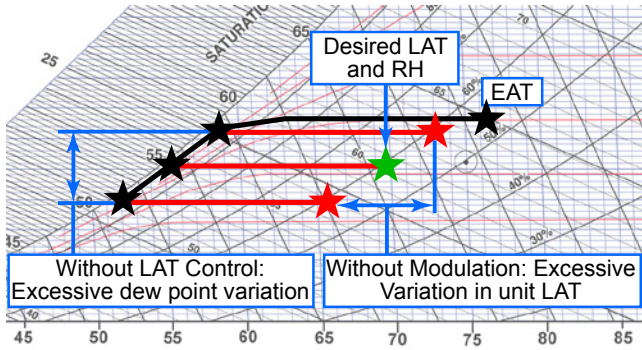

Figure 8: Modulating hot gas reheat is the best way to provide dehumidified 100% outdoor air at 70°F/60% RH

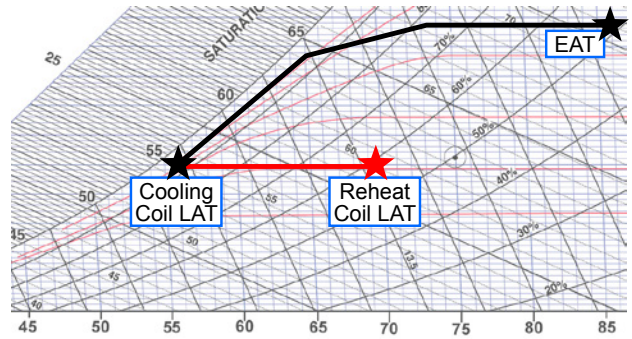
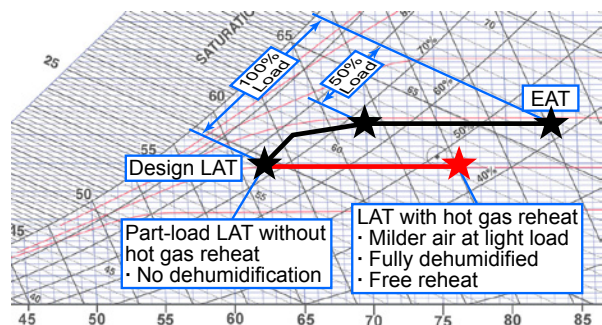

Figure 9: Hot gas reheat provides dehumidification at part load and a safety factor for humid climates



Supply and Return Fan Section

- Multiple double width, double inlet (DWDI) single width, single inlet (SWSI) forward curved and airfoil supply air fan selections provide efficient, quiet operation at wide ranging static pressure and cfm requirements
- Each fan assembly is dynamically trim balanced at the factory before shipment
- Neoprene gasket isolates the fan housing and eliminates vibration transmission to the fan bulkhead
- Solid steel fan shafts rotate in 200,000 hour, greaseable ball bearings
- All fan assemblies are isolated from the main unit on RIS or 2-in. deflection spring mounts
- Open drip-proof or totally enclosed motors comply with EPACT efficiency requirements. Premium efficiency motor upgrades available
- All fan drives are factory sized according to job specific airflow, static pressure, and power requirements
- Single width, single inlet (SWSI) airfoil return fans effectively handle high return duct static pressures and provide superior building static pressure control in VAV systems
- For seismic sensitive regions, spring fan isolators are available with seismic restraints
- 150% service factor drives extend service life of the fan belts
- Fan motor power factor correction to a minimum of 0.90
- Fan motor and drive assembly belt guards

Figure 10: DWDI Airfoil Fans (RPS/RFS)



Figure 11: SWSI Airfoil Fans (RDT)



Variable Air Volume Control

- Energy saving advanced technology variable frequency drive (VFD), fan speed control is available with the convenience and cost savings of factory mounting and testing.
- All VFD selections are plenum rated and are conveniently mounted within the filtered air stream for extended service life and easy accessibility to maintenance and service personnel.
- To manage building static pressure, dedicated VFDs are used for the supply and return fans.
- MicroTech III controls provide advanced duct and building static pressure control and equipment diagnostics capability.

Figure 12: Factory-Installed Variable Frequency Drive



Supply and Return Air Plenum

- Application flexibility of bottom, side, top and front (RFS only) discharge locations and bottom and back return locations to match complex system configuration requirements
- Available with burglar bars in both the discharge and return openings for added building security

Main Heat Section

Wide ranging natural gas, electric, steam and hot water heat selections effectively handle almost any heating demand from morning warm-up control to full heat.

Control of all heating options is fully integrated into the unit's MicroTech III control system.

Gas Heat

- Extensive selection flexibility from 200 to 2,000 MBh output can satisfy wide ranging needs. Two-stage, 3:1 and patented SuperMod 20:1 modulating control provides the flexibility to solve diverse needs
- All gas burners exceed ASHRAE Standard 90.1 efficiency requirement of 78% for low fire and 80% for high fire with efficiencies as high as 88% and 85%, respectively
- Gas furnace assemblies are ETL or ETL-Canada listed
- Special order capability with FM or IRI/FIA gas trains
- All burner assemblies are factory tested and adjusted prior to shipment
- Heat exchangers are a two-pass, drum-and-tube design with stainless steel primary and secondary surfaces
- Air temperature rise capability of up to 100°F on most models
- Burners are forced draft type with all controls and valves housed in the burner vestibule
- Designed for ease of inspection, cleaning and maintenance
- Patented design of integral flue improves combustion gas distribution, resulting in lower surface temperatures, reduced stresses and higher efficiencies
- High-pressure regulators (2 psi to 10 psi) also available.
- 321 stainless steel heat exchangers provide long life in 100% outside air applications
- Fuel lines may be conveniently routed through the curb or the burner vestibule door
- Heating control fully integrated into the unit's MicroTech III control system

SuperMod High Turndown Gas Burner

- Full 20:1 turndown with continuous modulation between 5% and 100% of rated capacity provides precise temperature control for a comfortable tenant environment, even in demanding applications such as dehumidification, 100% make-up air and VAV systems
- Solves the mixed air tempering requirements of VAV systems when meeting ASHRAE 62.1-2001 ventilation requirements at cold ambient, light load conditions
- Operates at normal inlet gas pressures, throughout the entire modulation range
- 14 burner sizes ranging from 200 MBh to 2,000 MBh output capacity
- Patent pending design featuring four unique design innovations and 37 patent claims

Figure 13: SuperMod 20:1 Burner Versus 3:1 Burner

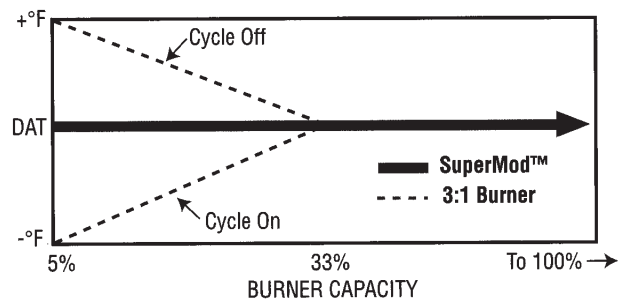

Electric Heat

- 40 kW to 320 kW selections factory assembled, installed and tested
- Single-stage or multi-stage capability for application flexibility
- Durable low watt density, nickel chromium elements for longer life
- Entire heat bank protected by a linear high limit control with each heater element protected by an automatic reset high limit control
- Fuses provided in each branch circuit
- MicroTech III controls sequence circuits for operating economy and reduced cycling wear

Steam Heat

- Steam heating coils are 1-row or 2-row, 5/8-in. O.D. copper tube/aluminum fin jet distributing type with patented HI-F5 fin design
- Rated in accordance with ARI Standard 430
- Four different steam coil selections offered to size heating output to application needs
- Factory-installed two-way modulating control valve, piping and modulating spring return actuator provide system control and full flow through the coil in the event of a power failure
- Available with factory-mounted freeze-stat

Hot Water Heat

- Hot water coils are 1-row or 2-row, 5/8-in. O.D. copper tube/aluminum fin design with patented HI-F5 fins
- Rated in accordance with ARI Standard 430
- Multiple coil selections offered to size heating output to application needs
- Factory-installed three-way modulating control valve, piping and modulating spring return actuator provide system control and full flow through the coil in the event of a power failure
- Heating control fully integrated into the unit's MicroTech III control system
- Available with factory-mounted freeze-stat

Outside/Return Air Section

100% Return Air Option

- Includes a return air plenum with a bottom, back or top return air opening

0% to 30% Outside Air Option

- Includes return air plenum and 0% to 30% outside air intake hood with patented UltraSeal low leak dampers to minimize leakage during off cycles

UltraSeal damper leakage is only 1.5 cfm per ft² of damper area at 1" static pressure differential and is 3 to 6 times better than ASHRAE 90.1 damper leakage requirements

- Damper is field adjusted to a fixed open position that is easily set using the MicroTech III keypad
- Available with two-position or modulating control

100% Outside Air Option

- Includes a weather hood factory mounted to the filter section, bird screen to help prevent infiltration of foreign objects and UltraSeal low leak dampers to minimize leakage during off cycles

UltraSeal damper leakage is only 1.5 cfm per ft² of damper area at 1" static pressure differential and is 3 to 6 times better than ASHRAE 90.1 damper leakage requirements

- Dampers arranged vertically and controlled by a two-position actuator, factory wired to sequence open when the supply fan is running and to close when the supply fan is OFF

0% to 100% Economizer Option

- Includes return air plenum with back or bottom opening, exhaust air dampers and UltraSeal low leak economizer intake dampers to minimize leakage during off cycles
- Available with or without a full return air fan
 - UltraSeal damper leakage is only 1.5 cfm per ft² of damper area at 1" static pressure differential and is 3 to 6 times better than ASHRAE 90.1 damper leakage requirements
- Outside air is introduced from both sides of the unit through outside and return air dampers that are arranged vertically to converge the multiple air streams in circular mixing patterns, minimizing temperature stratification and improving system performance
- 0% to 100% economizer sections use horizontal louvered intakes, eliminating unsightly hood assemblies
- Economizer control is fully integrated into the unit's MicroTech III control system and features spring return actuator, adjustable minimum outside air set point and adjustable changeover
- DesignFlow outdoor air control system measures outside air intake volume and automatically adjusts damper position to maintain minimum volume requirements
- Outside air enthalpy, comparative enthalpy or dry-bulb temperature changeover provides control flexibility to bring in the most economical amount of outside air for "free" cooling
- Exhaust dampers exhaust air out the back of the unit

Figure 14: Economizer Airflow

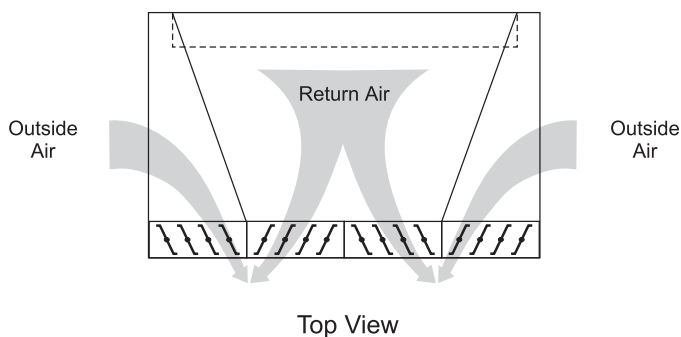
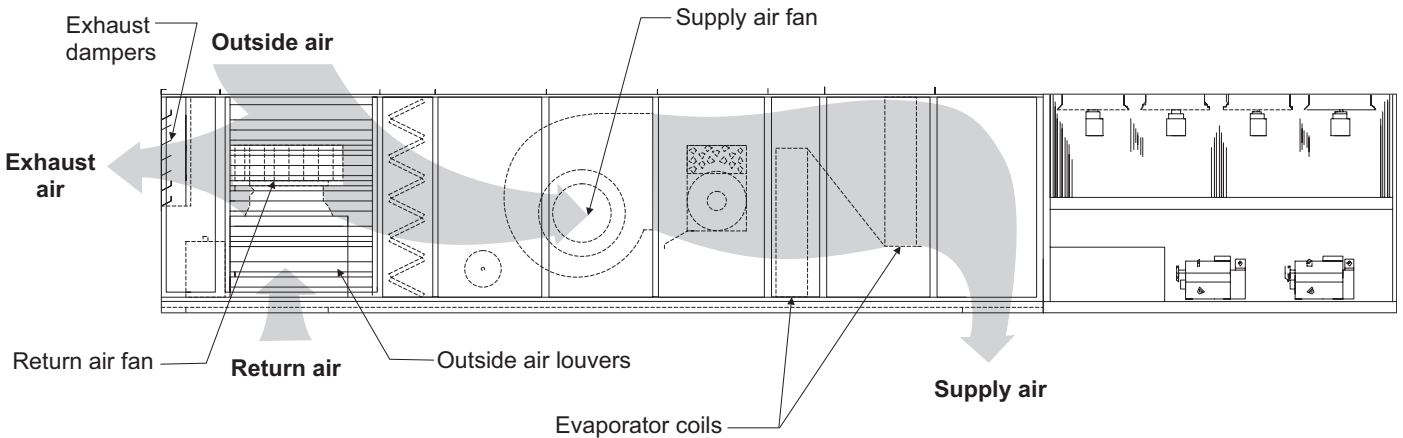

Figure 15: 0% to 100% Economizer with Propeller Exhaust Fans Centrifugal Return Fan Airflow Configuration



0% to 100% Economizer with Centrifugal Return Fan

Figure 15 shows return fan air flow configuration.

- All 0% to 100% economizer components are included
- Includes a DWDI forward curved or SWSI air foil, centrifugal return fan
- Return fans are in series with the supply fan and operate simultaneously with the supply fan to control building pressure and handle the return duct ESP at all times

NOTE: Return fans and exhaust fans have different performance characteristics and are not interchangeable. See [page 33](#) for application recommendations.

Figure 16 shows exhaust fan air flow configuration.

- All 0% to 100% economizer components are included
- Includes one to three propeller fans, depending on required capacity, all controlled from one VFD
- Exhaust fans are in parallel with the supply fan and may only operate during the economizer mode to control building pressure. They do not handle the return duct ESP design

NOTE: Return fans and exhaust fans have different performance characteristics and are not interchangeable. [Economizer, Return Fan and Exhaust Fan Application](#) on page 35.

Figure 16: Airflow Configuration—Exhaust Fan

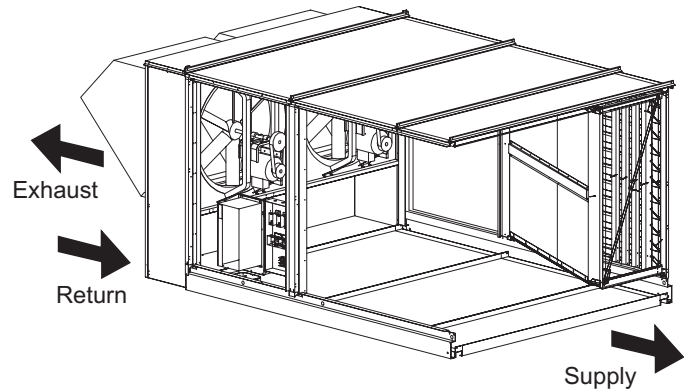

DesignFlow Precision Ventilation Air Control System

- Patented precision mass flow sensor assemblies directly measure the total mass volume of air flowing through the outdoor air intakes with accuracy exceeding 95% at the values indicated in [Table 3](#)
- Repeatable accuracy helps provide adequate ventilation air for good indoor air quality (IAQ), energy efficiency and compliance with [ASHRAE Standard 62.1-2001](#). See [Table 4 on page 30](#) for ventilation airflow measurement ranges verified by Intertek Testing Services, Inc.
- Pre-engineered, factory-installed and calibrated system requires no additional field-installed devices
- MicroTech III controls automatically respond to mass flow sensor signals and adjusts outdoor air damper position to maintain ventilation rate set point

Table 3: Ventilation airflow measurement range

Unit size	Ventilation airflow measurement range
015C to 030D	540 to 9,400 cfm
036C to 040D	808 to 13,120 cfm
045C to 075D	1080 to 18,000 cfm
080C to 135D	1594 to 37,126 cfm

Filter Section

- Selection flexibility includes large face, area angular filter racks with 2-inch, 30% (MERV 8) or 85% (MERV 13) panel filters, or high efficiency 65% (MERV 11) and 95% (MERV 14) cartridge filter assemblies with pre-filters
- Multiple access doors allow easy filter changes from either side of the unit
- 65% (MERV 11) and 95% (MERV 14) efficient filter selections feature permanent gaskets to seal against the cartridge filters and include a 2-inch, 30% MERV 8 pre-filter
- Extended filter face area arrangements meet a wide range of airflow requirements
- Double wall, 95% efficient final filter selections are available as the last section before the discharge plenum

Figure 17: Multiple Filter Options



Static Air Mixers

- Factory installed between the outside/return air section and the filter section
- Provides blended air temperatures to minimize the potential for freezestat trips when using a hydronic heating source
- Blended outside/return air streams improve system control and avoid uneven temperature distribution at the duct take-offs

Sound Attenuators

- Factory-installed downstream of the supply fan to dampen fan noise in sound sensitive applications
- Can reduce sound levels by as much as half in the lower octave bands and more than half in the higher octave bands
- Tedlar™ coating available for added protection of the acoustic insulation

Figure 18: Factory-Installed Sound Attenuators



Humidifiers

- Factory installed steam humidifier distribution grids downstream of the supply air fan

Electrical

- Units are completely wired and tested at the factory, with control wiring routed in an accessible, protective wire raceway at the base of the unit
- Wiring complies with NEC requirements and all applicable UL standards
- For ease of use, wiring and electrical components are number coded and labeled according to the electrical diagram
- Units have a 115V convenience receptacle
- Supply and return air fan motors, compressor motors, and condenser fan motor branch circuits have individual short circuit protection
- A single point power connection with power block or disconnect switch is standard
- A unit-mounted disconnect includes a service handle on the exterior of the control panel door
- Electrical power feeds inside the perimeter roof curb through factory provided knockouts in the bottom of the main control panel
- Dual disconnects are available on size 045C to 135C units to satisfy emergency power requirements. Supply and return fan motors and controls are on the emergency power circuit and the balance of the unit is on the other
- Phase-failure/under-voltage protection is available to protect three phase motors

Ultraviolet Lights

Factory-installed ultraviolet lights are available on the downstream side of all cooling coils and above the unit drain pan.

All ultraviolet lights are pre-engineered and factory installed for ease of use and proper placement for maximum effectiveness. The ultraviolet lamps irradiate the coil and drain pan surfaces with light in the 245 nanometer wavelength of the light spectrum (UV-C). UV-C light has proven effective in killing most bacteria, molds, and viruses in both laboratory and practical application. This complete package of equipment and ultraviolet lights includes Intertek Services Inc. (ETL) safety agency certification.

Features

- High-output, hot cathode lamps produce Ultraviolet Germicidal Irradiation (UVGI) for 254 nm that constantly irradiates the coil and drain pan surfaces
- Fixture design and stainless steel construction make the ultraviolet light device suitable for saturated air conditions
- Automatic disconnects are standard on all doors (or panels) with line-of-sight access to the lamps to help prevent eye contact with the UV-C ultraviolet light
- Special ultraviolet filtering glass windows block ultraviolet light, allowing the coil, drain pan, and lights to be inspected while in use from outside the unit

Benefits

- For pennies a day, UVGI can improve IAQ by destroying mold, fungi, and bacteria on coil and drain pan surfaces
- Clean coil surfaces maintain peak heat transfer for “near new” performance and lower energy costs
- Reduced coil and drain pan maintenance requirements and costs
- Satisfies GSA federal facilities standard requirements for UVGI lights to be incorporated downstream of all cooling coils and above all drain pans to control airborne and surface microbial growth and transfer-

Figure 19: Ultraviolet Light

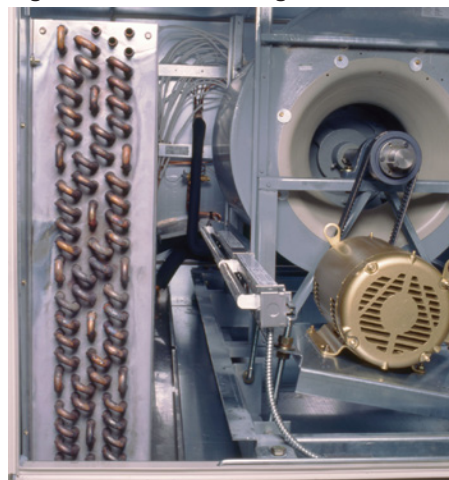

Variable Air Volume

Daikin RoofPak variable air volume systems (VAV) employ the concept of varying the air quantity to a space at a constant temperature thereby balancing the heat gains or losses and maintaining the desired room temperature. This true variable volume system is commonly referred to as a “squeeze-off” or “pinch-off” system. Unlike a “bypass” or “dump” system, supply air is diverted from areas where it is not required to areas that need cooling and, at system part load conditions, reduces the total fan volume. This ability to reduce supply air quantities not only provides substantial fan energy savings at partial load conditions, but it also minimizes equipment sizing.

Variable volume systems offer the following advantages:

- Lowers system first cost by using system diversity to reduce equipment and duct sizes
- Lowers operating costs by reducing fan energy demands, especially at part load conditions
- Lowers first cost by reducing space requirements for duct trunks and mechanical equipment
- Provides system flexibility to match changing occupancy demands

Variable Frequency Drives

Variable frequency drives offer reliable operation over a wide range of airflow, with advantages in sound and energy performance.

Variable frequency drives provide the most efficient means of variable volume control by taking advantage of the fan law relation between fan speed (rpm) and fan brake horsepower (bhp). Also, since airflow is reduced by changing fan speed, the noise penalties often associated with mechanical control devices, e.g. inlet vanes, are not introduced. The following equation illustrates how fan bhp varies as the cube of the change in fan speed:

$$hp_2 = hp_1 \left(\frac{\text{density}_2}{\text{density}_1} \right) \left(\frac{\text{rpm}_2}{\text{rpm}_1} \right)^3$$

In an ideal system, at 50% fan speed, brake horsepower would be reduced to 12.5% of that at full speed.

Variable frequency control varies the speed of the fan by adjusting the frequency and voltage to the motor. Keeping a constant volts/frequency ratio (constant magnetic flux) to the motor allows the motor to run at its peak efficiency over a wide range of speeds and resulting fan airflow volumes. Figure 21 illustrates on a fan curve the effect of varying air volume with a variable frequency drive.

Figure 20: Variable Frequency Drive



Figure 21: Variable Frequency Drive Control

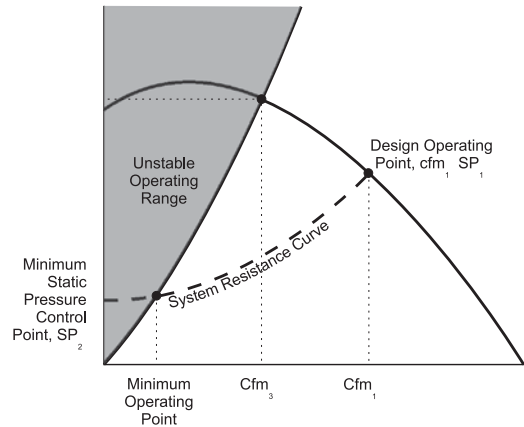

Airfoil Fans

To further enhance VAV system performance, Daikin RoofPak VAV systems use efficient airfoil fan selections. Daikin airfoil fan selections feature:

- Higher operating efficiencies than commonly used forward curved fans, reducing system energy demands and electrical requirements
- A non-overloading brake horsepower curve
- A single wheel design, eliminating potential problems with fan paralleling at light loads

Roof Curbs

- Constructed in accordance with NRCA guidelines with 12-gauge galvanized steel
- Fits inside the unit base around the perimeter of air handling section
- Duct frames are provided as part of each curb assembly to allow duct connections to be completed before the unit is placed
- Gasket seals between the curb duct frame and the unit
- Separate, factory-supplied steel rail supports condensing section to isolate noise and vibration from the air handling section, and to allow open roof access under the condensing section

Intelligent Equipment™

Intelligent Equipment (IE) from Daikin Applied is a secure, cloud-based controls solution that enables delivery of equipment and/or system information to customers via web or mobile devices.



A power measurement module and communications gateway installed on Daikin equipment enables the unit to be directly connected to the Internet via wireless (cellular, WI-FI) or local area network (LAN), providing management, monitoring control analysis and decision-making functionality for Daikin rooftop systems and the facility.

Features

- Remote monitoring and control of Daikin rooftop units
- Remote servicing capabilities
- Integration to the Energy Star® Portfolio Manager®
- Advanced data analytics including equipment performance, financial performance and building Comfort Index matrix based on ASHRAE Standard 55-2010
- Dynamic user dashboards with photo-realistic graphics and responsive-design interface optimized for users' mobile devices, tablets or PCs
- Secure, role-based user access

Benefits

- Informed decision-making
- Increased equipment efficiency
- 24/7 monitoring capability
- Real-time equipment information
- Accelerated equipment payback
- Historical performance data
- Can be used with, or without, an existing building automation system (BAS)

Figure 22: Intelligent Equipment Dashboards

Customer Dashboard

The Customer Dashboard provides a comprehensive overview of building performance. It includes sections for Building Status (Energy Star Score 100, My Usage Comparison), HVAC Summary (Unit Status: No Alarm, Maintenance: Not Needed, Live Power Usage: 0.45%), Financial Summary (Cumulative Savings graph), and Weather (Plymouth, MN). A detailed Building Info sidebar shows site details, a Comfort Index of 95%, and a graph of relative humidity over the last 30 days. Sustainability and Energy Star metrics are also visible at the bottom.

Technician Dashboard

The Technician Dashboard is designed for service personnel. It features a 'Unit Tag - RTU-4' section with a 'No Active Alarms' status and a 'Technician Read and Write Subscription' expiration date. The 'Overview Live Data' section provides real-time unit metrics such as Discharge Air Temperature (72.7 °F) and Return Air Temperature (60.9 °F). A detailed 'Overview' section includes a 3D model of the RTU-4 unit with numbered callouts (1-7) identifying key components like the ERW, Economizer & Filter Access, and various control panels. An 'Upcoming Maintenance' alert indicates that the unit is scheduled for weekly, bi-monthly, monthly, and annual maintenance.

- Integrated MicroTech III DDC controls with unit-mounted user interface featuring a 5-line, 22 character English display for fast equipment diagnostics and adjustments
- Factory-installed and commissioned prior to shipment
- 100% make-up air, dehumidification, VAV, or CV control capabilities
- Factory integrated minimum ventilation airflow measurement and control capability
- Open Choices feature allows interoperability with any BAS that uses BACnet and LonWorks protocols

Figure 23: MicroTech III Keypad/Display



MicroTech III Remote User Interface

In addition to the unit-mounted user interface provided with MicroTech III controls, Daikin applied rooftop systems and indoor vertical self-contained systems can be equipped with a remote user interface that handles up to eight units per interface. The remote user interface provides convenient access to unit diagnostics and control adjustments, without having to access your roof or mechanical rooms located on each floor.

Figure 25: Process Bus Wiring Connections

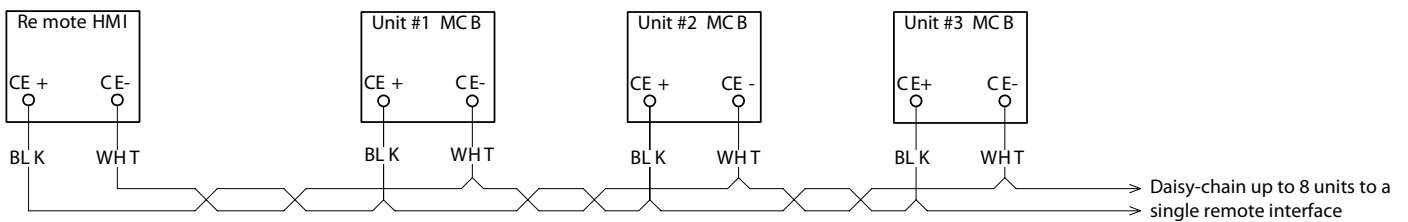

Each remote user interface offers similar functionality as its unit-mounted counterpart, including:

- Push-and-roll navigation wheel with an 8-line by 30-character display format
- Digital display of messages in English language
- All operating conditions, system alarms, control parameters and schedules are monitored

Features

- Can be wired up to 700 meters from units for flexibility in placing each remote user interface within your building
- Unit and remote user interfaces are both active

Benefits

- Allows you to access the user interface for each unit from one location, inside the building
- Users need to learn one format because the remote user interface is nearly identical to the unit-mounted version
- No additional field commissioning is required for the remote user interface

Figure 24: Remote User Interface

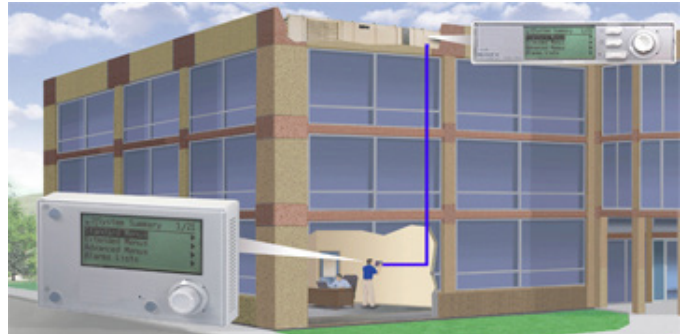

MicroTech III VAV Fan Tracking Control

A key element in successful VAV application is the ability to track supply and return air fan volumes so that proper building static pressure is maintained. Daikin, a pioneer in the development of rooftop VAV systems, developed its exclusive VaneTrol fan tracking control logic to solve this issue. Incorporating over 30 years of rooftop VAV system experience, the latest generation MicroTech III controls with VaneTrol logic provide advanced and accurate duct static pressure control plus supply and return fan tracking control that effectively and efficiently manages building static pressure.

The MicroTech III controller provides complete control of your variable frequency drive applications.

Daikin applied rooftop units are equipped with a complete MicroTech III controls system. The unit controllers are factory mounted and configured for stand-alone operation or integration with a building automation system (BAS) through an optional communication module with our Open Choices feature.

Open Choices Benefits for Easy Integration

- Easy, low cost integration into most building automation systems without costly gateway panels
- Flexibility to select either BACnet or LonWorks communication. Units are LonMark 3.4 certified with the appropriate communications module for LonWorks networks
- Comprehensive unit control and status information is available at the BAS regardless of communication protocol
- Long-term choices for equipment adds or replacements, and for service support
- Flexible alarm notification and prioritization with Intrinsic Alarm Management (BACnet)
- Simplified BAS integration with the ability to set network parameters at the unit controller, reducing installation time and costs
- Easy monitoring and troubleshooting of communication status from the unit controller to the BAS

Components

Each RoofPak applied rooftop system is equipped with a complete MicroTech III unit control system that is preengineered, preprogrammed, and factory tested prior to shipment. These components include:

- Unit controller with user interface display and navigation wheel
- Optional expansion modules
- Communication module (optional)
- Pressure transducers
- Unit-mounted temperature sensors
- Zone temperature sensor packages
- Humidity sensor

MicroTech III Unit Controller

The unit controller is preprogrammed with the software necessary to control the unit. Use the unit controller keypad display to keep schedules, set points and parameters from being lost, even during a long-term power outage. The unit controller processes system input data and then determines and controls output responses. An optional field- or factory-mounted BACnet or LonWorks communication module provides a network interface to the BAS.

Expansion Modules

These boards are used to expand the input and output capability of the unit controller. Each board communicates via serial data communications. These microprocessor based boards provide independent operation and alarm response even if communication is lost with the unit controller.

Communication Module

An optional communication module provides the means to factory or field configure MicroTech III unit controls for interoperability with an independent BAS. Communication modules are available to support industry recognized communication protocols including BACnet MS/TP, BACnet/IP and LonWorks.

Figure 26: Open Choices Integration

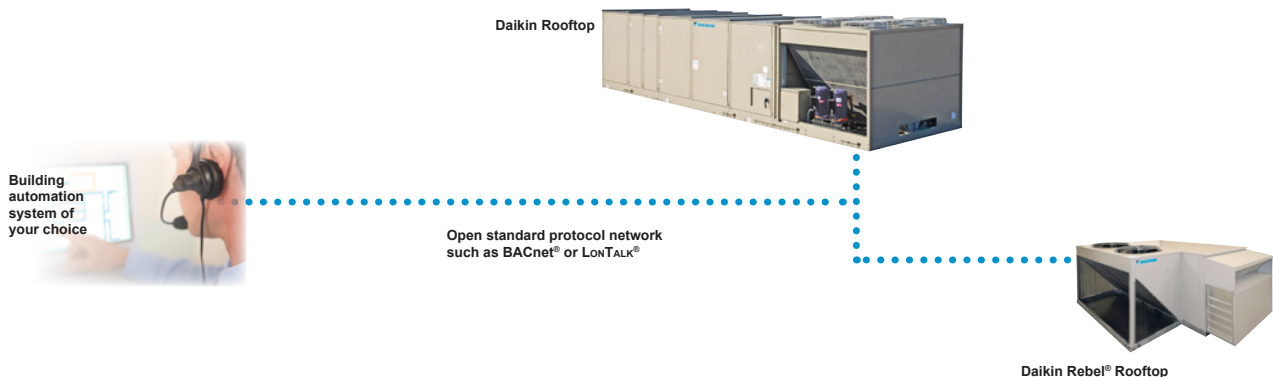

Keypad/Display

All MicroTech III unit controllers include a push/pull navigation wheel and display. The display is a supertwist nematic type with highly visible black characters on a yellow background. The 5-line by 22-character format allows for easy to understand plain English display messages. All operating conditions, system alarms, control parameters and schedules can be monitored from the keypad/display. If the correct password has been entered, any adjustable parameter or schedule can be modified from the keypad.

Figure 27: MicroTech III Keypad/Display

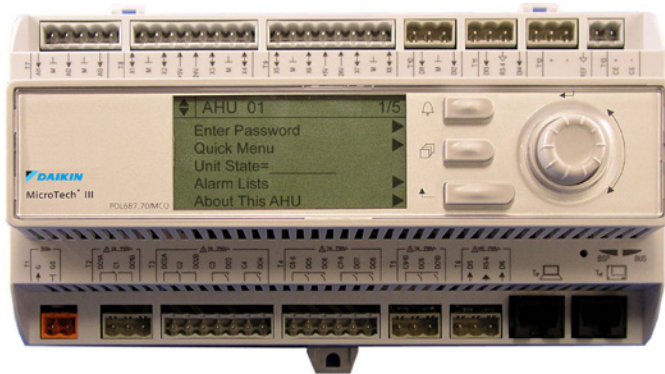

Temperature and Humidity Sensors

With the exception of the zone sensor, all temperature sensors are factory installed and tested. Zone sensor packages are available to suit any application. When required for dehumidification applications, a humidity sensor is available for field installation.

Static Pressure Transducers

All pressure transducers are factory installed and tested. Connection and routing of field-supplied sampling tubes is done at time of unit installation.

Zone Temperature Sensors

Two optional zone temperature sensors are available:

- Zone sensor with tenant override switch.
- Zone sensor with tenant override switch and remote set point adjustment.

Timed tenant override is a standard MicroTech III control feature.

Zone sensors are required for the controller's purge cycle, space reset of supply air set point, and night setback or setup features. All zone sensors are field installed with field wiring terminated at a separate, clearly marked terminal strip.

Stand-alone Controller Features

MicroTech III applied rooftop unit controls include all of the essential features required to make them capable of completely independent, stand-alone operation.

Internal Time Clock

An internal, battery-backed time clock is included in the MicroTech III unit controller. Current date and time can be quickly and easily set at the user interface keypad.

Internal Schedule

Seven daily schedules and one holiday schedule can be entered at the keypad of all unit controllers. For each of these eight schedules, one start and one stop time can be entered. Up to 10 holiday periods, of any duration, can be designated. The unit will automatically run according to the holiday schedule on the holiday dates. To handle special occasions, an additional 'one event' schedule can also be used.

In lieu of its internal schedule, the unit can be operated according to a network schedule from a BAS.

External Time Clock or Tenant Override Input

An input is supplied that can be used to accept a field wired start/stop signal from a remote source. An external time clock, a tenant override switch, or both may be connected. Whenever the external circuit is closed, the controller overrides the internal schedule (if activated) and places the unit into the occupied mode.

If the internal schedule or a BAS network schedule is used, field wiring is not required.

Timed Tenant Override

Off-hour operation flexibility is a must in today's office environments and even stand-alone MicroTech III controls handle it with ease. When unit operation is desired during unoccupied hours, initiate timed tenant override by pressing the tenant override button on either of the optional zone sensor packages. The unit then starts and runs in the occupied mode for a keypad-adjustable length of time (up to five hours). If the button is pressed again while the unit is operating, the timer resets to the full time allowance without interrupting unit operation. Tenant override operation also can be initiated by a BAS.

Three Remote Set Point Adjustment Options

1. Remote user interface option (RUI). See [Variable Air Volume on page 19](#).
2. Building automation system (BAS). See [Open Choices Benefits for Easy Integration on page 23](#).
3. All constant air volume-zone temperature control (CAV-ZTC) unit controllers include an input that can be used to remotely adjust the zone cooling and heating set points. To use this feature, wire the optional zone sensor package with set point adjustment to the controller. The remote set point adjustment feature can be enabled or disabled from the keypad at any time. When enabled, remote set point adjustment is available even if the return temperature is selected to be the Control Temperature.

Auto/Manual Operation Selection

Automatic or manual operation can be controlled either remotely or at the keypad.

All controllers include three inputs that can be used to enable or disable cooling, heating, and fan operation from remote switches. With the “heat enable” and “cool enable” terminals, the operator can enable cooling, heating, or both as desired. Using the system “off” terminals, the operator can disable the fans, and thus the entire unit.

From the keypad, there are a variety of occupancy and auto/manual control mode selections available to the operator:

- Occupancy modes
 - Auto
 - Occupied
 - Unoccupied
 - Bypass (tenant override)
- Control modes
 - Off manual
 - Auto
 - Heat/cool
 - Cool only
 - Heat only
 - Fan only

Compressor Lead-lag Selection

All unit controllers are capable of automatic compressor, lead-lag control. If automatic control is not desired, the operator can assign fixed lead and lag designations to the compressor circuits.

Lead and Lag is not available on units with variable speed inverter compressors.

Compressor Sequencing Selection

Because all applications are not the same, MicroTech III controls provide two choices for compressor capacity staging. For high sensible demand, comfort cooling applications, “cross-circuit” unloading can be chosen to maximize part load efficiency. Cross circuit unloading takes maximum advantage of available condenser and evaporator surface areas. Select “lead-loading” whenever part load dehumidification capability is of primary importance.

Economizer Changeover Selection

On units equipped with an economizer, there are three methods of determining whether the outdoor air is suitable for free cooling: two methods sense enthalpy (dry bulb temperature and humidity) and one senses outdoor air dry bulb temperature.

The two enthalpy changeover methods use external, factory installed controls. One compares the outdoor ambient enthalpy to a set point; the other is a solid state device that compares the outdoor ambient enthalpy to the return air enthalpy. This comparative enthalpy control can improve total economizer performance.

All unit controls include an internal dry bulb changeover strategy that can be selected at the keypad. When this method is selected, the controller compares the outdoor air dry-bulb temperature to a keypad programmable set point. The external enthalpy control input is then ignored.

Cooling and Heating Lockout Control

All unit controls include separate keypad programmable set points for locking out mechanical cooling and heating. Mechanical cooling is locked out when the outdoor temperature is below the cooling lockout set point; heating is locked out when the outdoor temperature is above the heating lockout set point. This feature can save energy cost by eliminating unnecessary heating and cooling during warm-up or cool-down periods or when the outdoor air temperature is mild.

Night Setback and Setup Control

When one of the zone temperature sensors is connected to the unit controller, night setback heating and night setup cooling control are available. Separate, keypad programmable night heating and cooling set points are used to start the unit when necessary. After the unit starts, night setback and setup control is similar to normal occupied control except that the minimum outside air damper position is set to zero. If the outside air is suitable for free cooling, it is used during night setup operation.

Except for 100% outside air applications, night setback control is available even if the unit is not equipped with any heating equipment. When the space temperature falls to the night setback set point, the fans simply start and run until the temperature rises above the differential. This feature might be useful for applications that use, for example, duct-mounted reheat coils.

Morning Warm-up Control

If the Control Temperature (space or return) is below set point when the unit enters the occupied mode, the morning warm-up control function will keep the outside air dampers closed while heat is supplied to satisfy set point. The outside air damper will remain closed until either the space temperature rises to the heating set point or the keypad adjustable morning warm-up timer expires (default is 90 minutes). The morning warm-up timer supplies the minimum required amount of outdoor air after a certain time regardless of the space temperature.

Morning warm-up control is automatically included on all except 100% outside air units. It is available even if the unit is not equipped with any heating equipment, for applications that utilize, for example, duct-mounted reheat coils.

Proportional Integral (PI) Control

The Proportional Integral (PI) control algorithm controls modulating actuators to maintain a measured variable (temperature or pressure) at or near its set point. For example, it controls economizer dampers to maintain the discharge cooling set point and it controls the supply fan variable frequency drives to maintain the duct static pressure set point. The integral control feature effectively eliminates “proportional droop” (load dependent offset) resulting in the tightest possible control.

For each PI loop, four keypad adjustable parameters allow the control loop to be properly tuned for any application:

- Period
- Dead band
- Proportional band
- Integral time

Appropriate default values for these parameters are loaded into each controller. These default values will provide proper control for most applications; therefore, field tuning is usually not required and thus start-up time is reduced.

Change Algorithm

The PI function is also used to adjust set points instead of controlling variable speed drives or actuators directly. For example, in zone control applications, the PI loop automatically “changes” the discharge temperature set point (cooling or heating) as the Control Temperature deviates from the zone set point. Another PI loop then controls the economizer actuator or heating valve actuator using the current discharge temperature set point. Unlike a typical “master-submaster” reset strategy, this “cascade control” continuously adjusts the discharge set point, even if the Control Temperature’s deviation from set point remains constant. This means that the unit’s cooling or heating output is set according to the actual load, not just the current zone temperature. The tightest possible zone temperature control results because “proportional droop” (load dependent offset) is eliminated.

Calibrate

When initiated at the keypad by an operator, the Calibrate function automatically calibrates all actuator position feedback inputs and all pressure transducer inputs. It does this by shutting the unit down and then driving all actuators to the full closed and full open positions. The controller records the input voltage values that correspond to these positions. The pressure transducer input voltages, which are assumed for 0.00-in. W.C., are also recorded. When Calibrate is finished, enter an operator command at the keypad to start the unit.

Field Output Signals

All MicroTech III RoofPak controls include two solid-state relay outputs that are available for field connection to any suitable device: the remote alarm output and the occupied output. These two outputs are used to signal field equipment of unit status.

Remote Alarm Output:

The remote alarm output can be used to operate a 24 volt relay to provide a remote alarm signal to a light, audible alarm, or other device when an alarm condition exists at the unit.

Fan Operation Output:

The fan operation output is used to operate a 24 volt relay to control field equipment that depends on fan operation; for instance, to open field installed isolation dampers or VAV boxes. To allow actuators enough time to stroke, the fan operation output is energized three minutes before the fans start. It then remains energized until thirty seconds after the unit airflow switch senses no airflow. The fan operation output is on whenever the unit airflow switch senses airflow.

Standard Control Options

Model RPS, RDT, and RFS applied rooftop systems are available for most any constant or variable air volume application. MicroTech III controls offer three basic control configurations: variable air volume with discharge temperature control (VAV-DTC), constant air volume with zone temperature control (CAV-ZTC), and constant air volume with discharge temperature control (CAV-DTC), that use sophisticated state change control logic to provide stable, reliable and efficient control. When combined with MicroTech III’s many available control capabilities, both factory installed and keypad programmable, these three basic configurations can be customized to meet the requirements of the most demanding applications.

Variable Air Volume with Discharge Temperature Control (VAV)

All VAV units provide true discharge temperature control in addition to duct static pressure control. Cooling only, cooling with single-stage “morning warm-up” heat, and cooling with modulating heat configurations are available. On units with a return fan, two building static pressure control options are available: VaneTrol™ logic tracking or direct building pressure control. Because proper ventilation rates have been identified as critical to maintaining good indoor air quality, all RoofPak VAV controllers include software algorithms designed to maintain minimum outside air volume at all times when the unit is in the Occupied mode.

Constant Air Volume with Zone Temperature Control (CAV-ZTC)

CAV-ZTC units are available in either cooling only or cooling with modulating heat configurations. Either of these configurations is available for 100% recirculated, mixed, or 100% outdoor air applications. On units that have a return fan, a direct building static pressure control option is also available.

Constant Air Volume with Discharge Temperature Control (CAV-DTC)

CAV-DTC units are available in cooling only, cooling with single-stage “morning warm-up” heat, or cooling with modulating heat configurations. This unit configuration can be used for applications that have zone controlled terminal reheat coils or for constant volume, 100% outdoor air applications. The discharge temperature control strategies used with the hybrid CAV-DTC unit are identical to those used with the VAVDTC unit. On units that have a return fan, a direct building static pressure control option is available (constant supply air volume applications only).

Discharge Temperature Control

MicroTech III VAV-DTC and CAV-DTC controls provide sophisticated and flexible discharge air temperature control that is only possible with DDC systems. Separate discharge air temperature set points are used for cooling and modulating heating control. At the keypad, the operator can either enter the desired set points or select separate reset methods and parameters for each set point (see [Supply Air Reset on page 28](#)).

Control Temperature

The Control Temperature makes the heat/cool changeover decision. It determines whether cooling or heating is enabled; the discharge temperature then determines whether cooling or heating is actually supplied. At the keypad, the operator can choose the source of the Control Temperature from among the following selections.

- Space temperature sensor
- Return temperature sensor
- Outside air temperature sensor (modulating heat only)
- Network communication

The operator enters separate cool and heat enable set points and deadbands that the Control Temperature is compared with (see [Figure 28](#)). When the Control Temperature is greater than or equal to the cooling set point plus DB/2, cooling is enabled. When the Control Temperature is less than or equal to the heat set point minus DB/2, heating is enabled. If desired, these set points and differentials can be set so that there is a dead band in which both cooling and heating are disabled. The controller’s software prevents simultaneous cooling and heating.

Figure 28: Control Temperature Logic

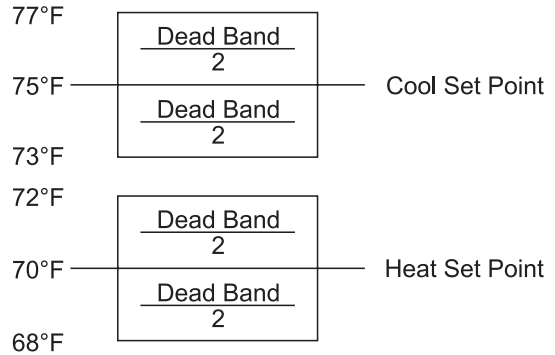

Proportional Integral Modulation

When operating in economizer free cooling or unit heating, the previously described PI algorithm maintains discharge temperature control. It provides precise control of the economizer dampers, modulating gas heat, steam or hot water valves.

Compressor Staging

Two staging algorithms are available to control a unit's multiple steps of capacity control, Degree-Time (also known as "average") and Nearest. These control algorithms provide reliable discharge temperature control while managing compressor cycling rates. Constraints on compressor staging are essential for preventing short cycling, which can reduce compressor life by causing improper oil return and excessive heat buildup in the motor windings.

The Degree-Time Compressor staging algorithm keeps track of the discharge temperature and stages cooling up or down to maintain an average temperature that is equal to the discharge cooling set point. A stage change can occur only (1) after the keypad adjustable inter-stage timer has expired (five minute default setting) and (2) if the discharge temperature is outside a keypad programmed dead band. After these two conditions have been met, staging occurs as the controller attempts to equalize two running totals: degree-time above set point and degree-time below set point. The result is that the average discharge temperature is maintained at the cooling set point.

The Nearest Compressor staging algorithm keeps track of the discharge temperature and stages cooling up or down to maintain the discharge temperature as close as possible to set point. A stage change can occur only (1) after the keypad adjustable inter-stage timer has expired (five minute default setting) and (2) if the control logic calculates that a stage change will result in a discharge temperature closer to set point than the existing condition. The controller logic continually calculates the expected effect of a stage change and uses this information before making a change. A change is made only if it will bring the discharge temperature closer to set point, resulting in a more consistent discharge temperature, reduced compressor cycling and more stable control VAV box control.

Supply Air Reset

By automatically varying the discharge air temperature to suit a building's cooling or heating needs, supply air temperature reset can increase the energy efficiency of VAV and CAV-DTC systems. MicroTech III controllers offer a variety of different reset strategies that can be selected at the keypad. Because they are keypad programmable, reset strategies can be changed or eliminated as desired. Separate strategies can be selected for both cooling and modulating heat. If reset is not desired, a fixed discharge cooling or heating set point can be entered.

The following reset methods are available:

- Space temperature
- Return temperature
- Outdoor air temperature
- Supply airflow (VAV, cooling set point only)
- External 0–10 VDC or 0–20 mA signal
- Network communication

For all temperature reset methods, the minimum and maximum cooling and heating set points are keypad programmable along with the corresponding minimum and maximum space, return or outdoor air temperature parameters. For the supply airflow method, the discharge set point will be reset as the supply fan modulates between 30% adjustable and 100% adjustable. For the external method, the discharge set point will be reset as the voltage or current signal varies over its entire range. For units in a BAS network, the discharge set points are reset via the communication signal.

Zone Temperature Control

MicroTech III CAV-ZTC controls provide the sophisticated and flexible zone temperature control that is only possible with DDC systems. Zone temperature sensors are available with or without a remote set point adjustment. With the remote adjustment model, the space set point can be set at the keypad or at the zone sensor package. Even if a zone sensor is connected, remote set point adjustment can be enabled or disabled as desired at the keypad.

Control Temperature

The Control Temperature is the representative zone temperature. When compared with the zone set points, the Control Temperature determines whether the unit supplies heating, cooling, or neither. It also determines the amount of cooling or heating required to satisfy the load. Its source can be selected at the keypad from among the following selections:

- Zone temperature sensor
- Return temperature sensor

Because it is the representative zone temperature, the Control Temperature is the primary input to the MicroTech III zone temperature control algorithms. Control Temperature parameters are described below. The controller's software will prevent cooling and heating from being inadvertently enabled at the same time.

Change and Proportional Integral Modulation

When economizer “free” cooling or unit heating is required, the two MicroTech III PI loops combine for cascade-type control, providing the tightest possible zone temperature control. By controlling the discharge temperature along with the zone temperature, these functions eliminate temperature variations near the diffusers that could otherwise occur as a result of traditional zone control’s inherent lag effect.

Change: If the Control Temperature is above or below the set point by more than the dead band, the Change PI loop periodically adjusts the cooling or heating discharge air temperature set point either up or down as necessary. The amount of this set point change corresponds to the Control Temperature’s position in the modulation range. The farther the Control Temperature is from the set point, the greater the discharge set point change will be. The Change-adjusted discharge cooling and heating set points are limited to ranges defined by keypad programmable maximum and minimum values.

PI: Using the Change function’s current discharge set point, the PI function maintains precise discharge temperature control by modulating the economizer dampers and gas heat, steam or hot water heating valves.

Compressor Staging

Compressor staging is controlled directly by the Control Temperature. When the Control Temperature is warmer than the zone cooling set point, cooling is staged up; when the Control Temperature is cooler than the zone cooling set point, cooling is staged down. However, a stage change can only occur when the Control Temperature is outside the dead band (see Figure 29). Staging is constrained by an inter-stage delay timer (five minute default setting) and minimum and maximum discharge air temperature limits (all keypad programmable). These constraints protect the compressors from short cycling while eliminating temperature variations near the diffusers.

Figure 29: Compressorized Logic

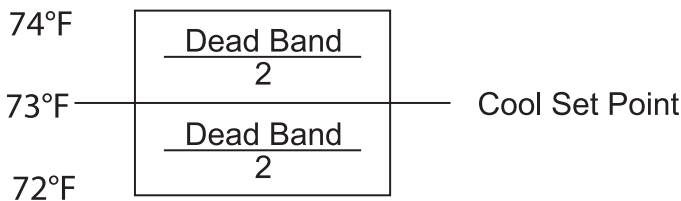

Project Ahead Algorithm

Because the inherent lag effect in zone temperature control applications can cause overshoot during warm-up or cool-down periods, MicroTech III features a “Project Ahead” control algorithm. Project Ahead calculates the rate at which the Control Temperature is changing and reduces the unit’s cooling or heating output as the zone temperature nears its set point, essentially eliminating overshoot.

Duct Static Pressure Control

On all VAV-DTC units, duct static pressure control is maintained by the PI algorithm, which provides precise control of the supply fan variable speed drive. The keypad programmable set point can be set between 0.20-in. W.C. and 4.00-in. W.C.

On larger buildings with multiple floors, multiple trunk runs or large shifts in load due to solar effects (east/west building orientation), an optional second duct static sensor is offered. The MicroTech III controller automatically selects and uses the lower of the two sensed pressures to control fan volume to provide adequate static pressure to the most demanding space at all times.

Building Static Pressure Control

VaneTrol™ Fan Tracking Control (does not apply to exhaust fans)

VaneTrol fan tracking control logic offers close and reliable building static pressure control for VAV units equipped with a return air fan. With the VaneTrol logic method, the return fan’s variable speed drive assembly tracks the supply fan volume as the supply fan maintains the required duct static pressure using the additional parameter of maintaining a field programmable offset between supply fan and return fan volume. The result is that building pressure is maintained, regardless of the building cooling load, because the proper relationship between supply and return fan volume is maintained. Because the return fan/supply fan tracking relationship is established once during controlled test-and-balance conditions, ongoing building pressure control is not affected by a fluctuating ambient pressure reference signal or the temporary effects of opening and closing doors on a pressure sensor in the lobby.

VaneTrol control logic uses four keypad programmable parameters to maintain the required relationship between return fan and supply fan volumes. These are the supply and corresponding return fan volumes as measured by variable speed drive position, at both maximum and minimum airflow conditions.

Table 4 shows an example of how supply and return air fan modulation must vary to maintain the correct balance of supply and return air volumes based on the building’s parameters and therefore maintain building pressure. Determining the building’s correct VaneTrol parameters is easy with MicroTech III’s Balance feature. With Balance, start-up time is reduced because final adjustments are made at the keypad.

Table 4: VaneTrol Logic Air Balancing

SAF cfm	RAF cfm	Building exhaust
16000 (100%)	14000 (100%)	2000
14000 (88%)	12000 (80%)	2000
12000 (75%)	10000 (71%)	2000
10000 (63%)	8000 (57%)	2000
8000 (50%)	6000 (43%)	2000

Direct Space Pressure Control (for return or exhaust fans)

Any constant or variable air volume unit equipped with a variable volume return or exhaust fan can be provided with direct building static pressure control capability. With the direct method, building static pressure is measured and processed by the PI algorithm. This algorithm provides precise control of the return fan variable speed drive or inlet vanes to maintain the space pressure set point. The range of the keypad programmable set point is between minus 0.25-in. W.C. and 0.25-in. W.C.

This type of control can be used for either whole building or lab pressurization (positive or negative) applications, or exhaust fan control where VaneTrol control logic does not apply.

Minimum Ventilation Air Volume Control

Consistently maintaining the minimum outdoor air requirements of ASHRAE Standard 62-1999 has been a long standing control challenge for VAV systems. As supply air fan volumes were reduced, the volume of air introduced through a fixed position, minimum outdoor air damper was also reduced, compromising indoor air quality. To meet this challenge, MicroTech III controls feature four user-selected control methods for maintaining outdoor air volume.

- The MicroTech III controller can accept a signal from a DesignFlow Precision Ventilation Air Control System, which is continuously measuring outdoor air volume, and adjust outdoor air damper position to maintain the minimum volume set point.
- MicroTech III controls have a keypad selected control function that automatically adjusts outdoor air damper position in response to changes in supply air fan volume. Regardless of supply air volume, this strategy maintains a nearly constant outdoor air volume at all times. The MicroTech III controller can accept an external 0–10 VDC signal from a CO₂ sensor or other control device and adjust outdoor air damper position.
- If desired, a fixed minimum damper position can be keypad programmed. This selection may be acceptable when ventilation requirements are met through other sources.

During cold ambient conditions where outdoor/return mixed air conditions can become too low, MicroTech III controls maintain the cooling discharge temperature set point by controlling the unit heating system. For applications where ambient temperatures and minimum outdoor air requirements can generate this condition, order the RoofPak unit with modulating heating equipment, such as the SuperMod gas burner.

Table 5 illustrates the effect of minimum ventilation control and cold ambient conditions on unit discharge air temperature and how it dictates the need for mixed air tempering capability at the light load/low ambient conditions. It assumes a VAV unit with a 20% outdoor air requirement at design conditions and a 40% minimum airflow requirement.

Table 5: Effect of Minimum Ventilation Control on Discharge Temperature

Supply fan volume (cfm)	Outdoor air volume (cfm)	Outdoor air volume (%)	Outdoor air temp (°F)	Mixed air temp (°F)
10,000	2,000	20	95	79
8,000	2,000	25	70	73.8
6,000	2,000	33.3	40	63.3
4,000	2,000	50	0	37.5

Operating States

Operating states define the current overall status of the rooftop system. At the user interface, the operator can display the current operating state and thereby quickly assess the unit's operating condition. [Figure 30](#) shows all possible operating states and the status information they summarize. Depending on unit options, some operating states may not apply. For example, a 100% outside air unit does not have a Morning Warm-Up, Economizer or Unoccupied Economizer operating state. Below are descriptions of each operating state.

Alarm Management and Control

MicroTech III unit controllers are capable of sophisticated alarm management and controlled response functions. Each alarm is prioritized, indicated, and responded to with the appropriate action. The active alarm (up to 10 alarms, arranged by alarm priority) and previous alarm (up to 25 alarms, arranged by date/time cleared), each with a time and date stamp, can be displayed at the user interface. Generally speaking, whenever a current alarm is cleared, it is logged as a previous alarm and the oldest previous alarm is removed.

Alarm Priority

The various alarms that can occur are prioritized according to the severity of the problem. Three alarm categories are used: faults, problems, and warnings.

1. Faults are the highest priority alarms. If a fault condition occurs, the complete unit is shut down until the alarm condition is gone and the fault is manually cleared at the keypad. A fault example is Fan Fail alarm.
2. Problems are the next lower priority to faults. If a problem occurs, the complete unit does not shut down, but its operation is modified to compensate for the alarm condition. A problem automatically clears when the alarm condition that caused it is gone. Compressor Fail is an example of a problem where only the affected compressor is shut down.
3. Warnings are the lowest priority alarms. No control action is taken when a warning occurs; it is simply indicated to alert the operator that the alarm condition needs attention. To remind the operator to read warnings, they must be manually cleared. Dirty Filter indication is an example of a warning.

Generally, a specific alarm condition generates an alarm that falls into only one of these categories. Under different sets of circumstances, however, the freezestat and most of the sensor failure alarm conditions can generate alarms that fall into multiple categories.

Adjustable Alarm Limits

Four alarm triggers have adjustable limits. The high return temperature alarm and the high and low supply temperature alarms are adjusted at the user interface. The dirty filter alarm(s) is adjusted at the sensing device. See [Table 6](#).

Multiple Air Handler Control

For applications in which multiple units are connected in a common duct system, it is important to control all units from a common duct static pressure sensor and to control all operating units in unison. Centralized duct static pressure control can be accomplished through communication with the BAS network.

Table 6: MicroTech III Alarm Summary

Alarm name	Fault	Problem	Warning
Freeze	X	X	
Smoke	X		
Temperature sensor fail	X	X	
Duct high limit	X		
High return temp	X		
High discharge temp	X		
Low discharge temp	X		
Fan fail	X		
Fan retry		X	
Discharge Air Capacity Feedback	X		
OA Damper Stuck	X		
Auxiliary Control Board Enable		X	
Auxiliary control board communications		X	
Low airflow		X	
Heat fail		X	
Circuit 1 & 2 high pressure		X	
Circuit 1 & 2 low pressure		X	
Circuit 1 & 2 frost protect		X	
Compressor 1-6 fail		X	
Circuit 1 & 2 incomplete pumpdown		X	
Airflow switch (false airflow)			X
Dirty filter			X
Dirty final filter			X

Figure 30: Operating State Sequence Chart

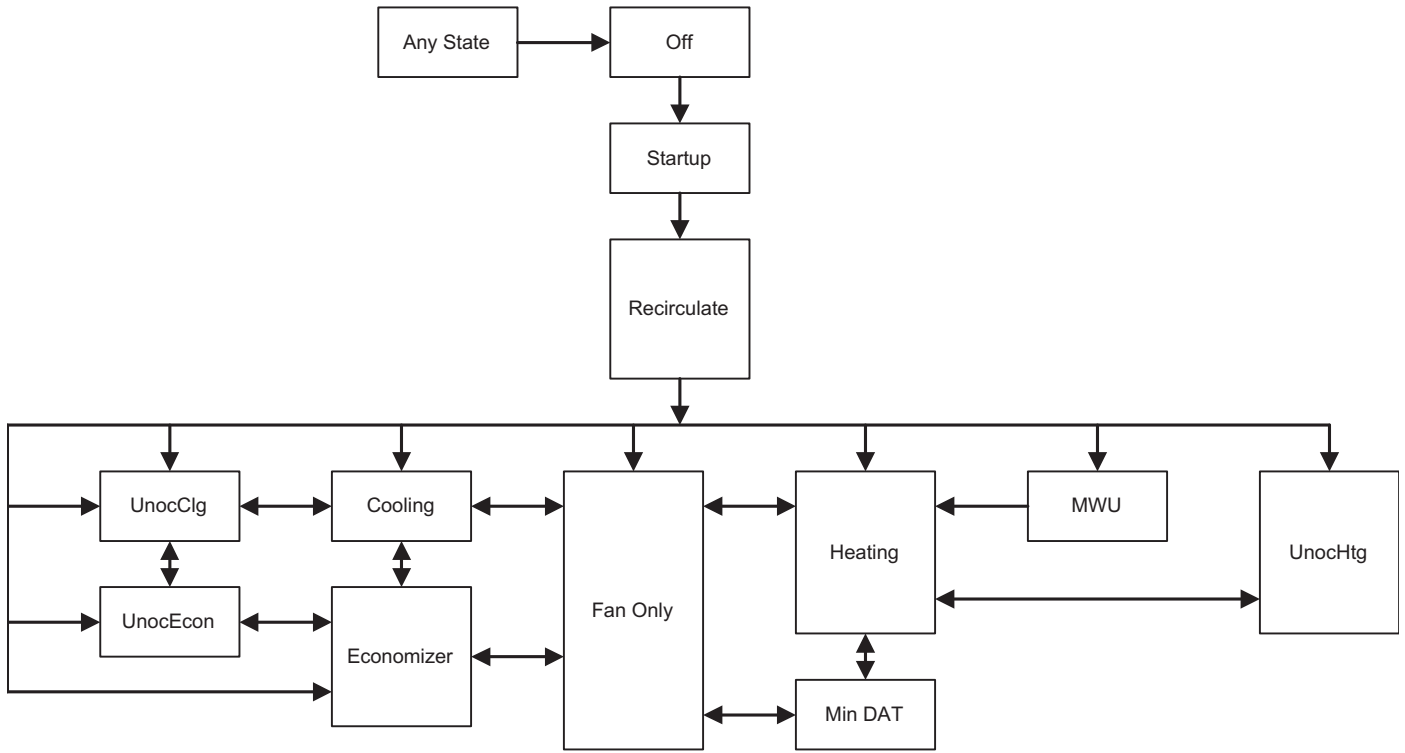

The following section contains basic application and installation guidelines that must be considered as part of the detailed analysis of any specific project.

General

Units are intended for use in normal heating, ventilating and air conditioning applications. Consult your local Daikin sales representative for applications involving operation at high ambient temperatures, high altitudes, non-cataloged voltages and for applications requiring modified or special control sequences. Consult your local Daikin sales representative for job specific unit selections that fall outside of the range of the catalog tables, such as 100% outside air applications.

For proper operation, units should be rigged in accordance with instructions stated in [IM 485](#). Fire dampers, if required, must be installed in the ductwork according to local or state codes. No space is allowed for these dampers in the unit.

Follow factory check, test and start procedures explicitly to achieve satisfactory start-up and operation (see [IM 485](#)).

Most rooftop applications take advantage of the significant energy savings provided with economizer operation. When an economizer system is used, mechanical refrigeration is typically not required below an ambient temperature of 50°F. Standard RoofPak refrigeration systems are designed to operate in ambient temperatures down to 45°F. For applications where an economizer system cannot be used, Daikin's VFD, condenser fan, head pressure control system is available for operations down to 0°F. However, if the condenser coils are not properly shielded from the wind, the minimum ambient conditions stated above must be raised.

Unit Location

The structural engineer must verify that the roof has adequate strength and ability to minimize deflection. Take extreme caution when using a wooden roof structure.

Locate the unit fresh air intakes away from building flue stacks or exhaust ventilators to reduce possible reintroduction of contaminated air to the system. Unit condenser coils should be located to avoid contact with any heated exhaust air.

Allow sufficient space around the unit for maintenance/service clearance as well as to allow for full outside air intake, removal of exhaust air and for full condenser airflow. Refer to [Application Considerations on page 33](#) for recommended clearances. Consult your Daikin sales representative if available clearances do not meet minimum recommendations. Where code considerations, such as the NEC, require extended clearances, they take precedence.

In applications utilizing a future cooling unit (RFS), take care in choosing a location of the unit so it provides proper roof support and service and ventilation clearance necessary for the later addition of a mechanical cooling section (RCS).

Split Units

Units may sometimes have to be split into multiple pieces to accommodate shipping limitations or jobsite lifting limitations. Units exceeding 52 feet in length may need to be split for shipping purposes. Units exceeding the rating of an available crane or helicopter may also need to be split for rigging purposes. Unit can be split between the supply fan and heat section. Contact your local Daikin sales representative for more details.

Curb Installation

The roof curb is field assembled and must be installed level (within 1/16 in. per foot side to side). A sub-base has to be constructed by the contractor in applications involving pitched roofs. Gaskets are furnished and must be installed between the unit and curb. For proper installation, follow NRCA guidelines. Typical curb installation is illustrated in [Roof Curbs Dimensions on page 90](#). In applications requiring post and rail installation, an I-beam securely mounted on multiple posts should support the unit on each side.

Applications in geographic areas that are subjected to seismic or hurricane conditions must meet code requirements for fastening the unit to the curb and the curb to the building structure.

For acoustical considerations, the condensing section is provided with a support rail versus a full perimeter roof curb. When curbs are installed on a built-up roof with metal decking, an inverted 6-in. channel should be provided on both sides of the unit. Acoustical material should be installed over the decking, inside the roof curb. Only the supply and return air ducts should penetrate the acoustical material and decking. Apply appropriate acoustical and vibration design practices during the early stages of design to provide noise compatibility with the intended use of the space. Consult your Daikin sales representative for unit sound power data.

Acoustics

Good acoustical design is a critical part of any installation and should start at the earliest stages in the design process. Each of the four common sound paths for rooftop equipment must be addressed. These are:

- Radiated sound through the bottom of the unit (air handling section and condensing section) and into the space. Structure-borne vibration from the unit to the building
- Airborne sound through the supply air duct
- Airborne sound through the return air duct

Locating rooftop equipment away from sound sensitive areas is critical and the most cost effective means of avoiding sound problems. If possible, rooftop equipment should always be located over less sensitive areas such as corridors, toilet facilities or auxiliary spaces and away from office areas, conference rooms and classrooms. If the air handler must be located above or near a sensitive area, then consider an RFS/RCS split system and move the RCS to a less sensitive area.

Some basic guidelines for good acoustical performance are:

- Use the Quiet Condenser option when radiating noise is a concern
- Always provide proper structural support under all areas of the unit
- Always locate the unit's center of gravity close to a main support to minimize roof deflection. Maintaining a roof deflection under 1/3 in. minimizes vibration-induced noise
- Use a concrete deck or pad when a unit has to be located over an occupied space where good acoustics are essential
- Only the supply and return air ducts should penetrate the acoustical material and decking within the curb perimeter, and the openings must be sealed once the duct is installed
- Don't overlook the return air path. Never leave a clear "line of sight" into a return or exhaust fan; always include some duct work (acoustically lined tee) at the return inlet
- Place an acoustical material in the area directly beneath the condensing section
- Select acoustical material that does not encourage microbial growth
- Minimize system static pressure losses to reduce fan sound generation

- Select the appropriate fan for the application. Fans should be selected as close as possible to their peak static efficiency. To assist you, peak static efficiency is identified by the first system curve to the right of the shaded "Do not select" region, as illustrated in [Figure 31](#)
- Design duct systems to minimize turbulence
- Account for low frequency duct breakout in system design. Route the first 20 ft. of rectangular duct over non-sensitive areas and avoid large duct aspect ratios. Consider round or oval duct to reduce breakout
- When an added measure of airborne fan sound control is required, sound attenuators can be supplied, factory installed in a unit discharge air section, to treat the supply fan. On the return side, additional attenuation can often be achieved by routing the return duct within the curb area beneath the unit

There are many sound sources in rooftop systems. Fans, compressors, condenser fans, duct take-offs, etc. all generate sound. For guidelines on reducing sound generation in the duct system, refer to the [2003 ASHRAE Applications Handbook, Chapter 47](#).

Contact your local Daikin sales representative for equipment supply, return and radiated sound power data specific to your application.

Figure 31: Optimal Fan Selection Line

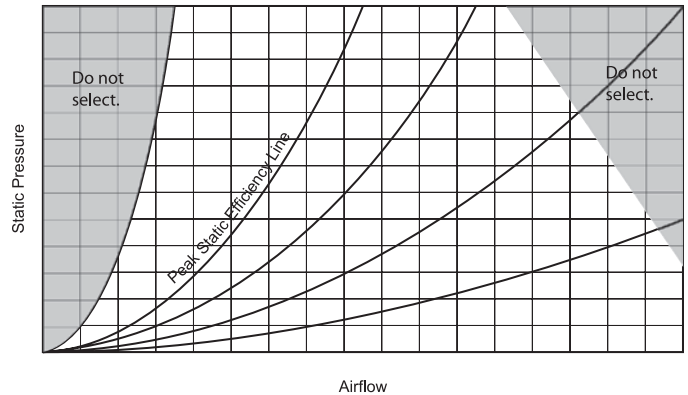

Economizer, Return Fan and Exhaust Fan Application

Rooftop economizer applications usually require return or exhaust fans to properly control building pressure and minimum ventilation. Daikin offers both exhaust and return fan capability. They are not generally interchangeable for a given design and perform differently. In general:

- Return air fans (RAF) are best suited for ducted return systems (return ESP exceeds 0.4" to 0.5").
- Exhaust air fans (EAF) are best suited for open return systems (return ESP is less than 0.4" to 0.5").
- Supply air fan (SAF) selection depends on whether a return or exhaust fan is used.
 - RAF system-SAF handles only the supply ESP at design.
 - EAF system-SAF handles both the supply and return ESP at design (EAF is off).

Figure 32 illustrates why SAF only units often cannot control building pressure and ventilation, especially as return ESP increases.

- Desired space pressure is approximately 0.1" as shown
- No exhaust will occur from the rooftop because the economizer section must be at a negative pressure. Therefore, space pressure rises until exhaust occurs through doors and walls
- The air balancer must adjust the outdoor air damper to be "almost shut" and generate large pressure drops at minimum ventilation settings (about 0.9" in Figure 32). Otherwise excess outdoor air would be pulled in. Ventilation control is much less accurate at the "almost shut" damper position, especially on VAV systems where minimum position varies with load

Figure 32: Supply Air Fan Only System Static Pressures with 1" Return Duct ESP

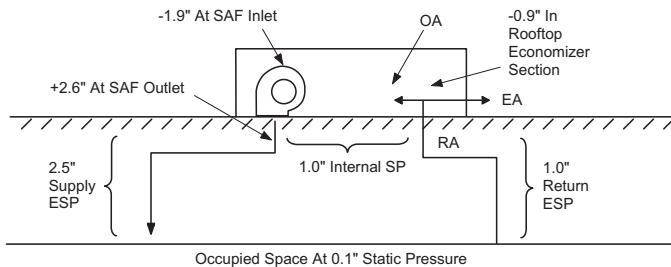
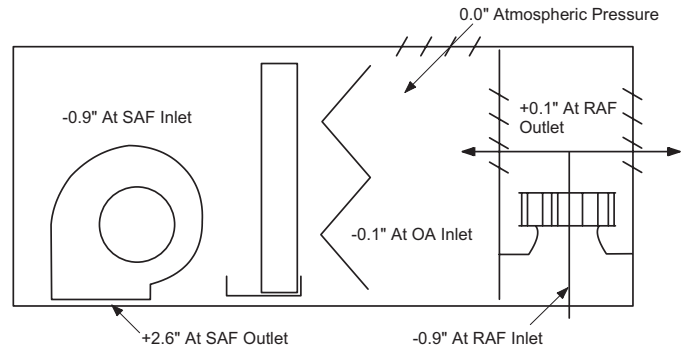

Figure 33 illustrates how the addition of a RAF corrects these problems. The RAF is responsible for return system ESP and maintains a slightly positive pressure in the economizer section (about +0.1" in Figure 33) to allow for proper exhaust and better ventilation control.

Figure 33: RAF System Allows Proper Exhaust and Outdoor Air Control



EAFs are very different from RAFs.

- EAFs provide less effective building pressure and ventilation control as return duct ESP increases. The EAF is normally off during non-economizer operation. During these minimum outdoor air conditions, the system essentially acts like a SAF only system
- EAFs cannot maintain a slightly positive pressure in the economizer section, so ventilation control is no better than that of an SAF only system
- EAFs can successfully operate and save energy on designs with reduced return ESP for the following reasons
 - EAFs and RAFs are generally much less efficient than SAFs. EAFs can sometimes be cycled off while RAFs must always run. If a non-overloading, airfoil SAF is used then energy generally is saved when the EAF is cycled OFF
 - Exhaust fans are designed for peak exhaust CFM which occurs during economizer operation. RAFs must be sized for design return CFM. Peak exhaust CFM generally is less than the design return CFM

Fan Isolation

All Daikin RoofPak systems feature internally isolated fans. All supply and return air fans are statically and dynamically balanced in the factory and mounted on rubber-in-shear (RIS) or 2-in. deflection spring isolators. Flexible isolation is provided as standard between the fan outlet and the discharge bulkhead to prevent hard contact and vibration transmission. Spring isolated fan assemblies also are available with seismic restraints.

The choice of 2-in. deflection spring isolation or RIS isolation depends on an analysis of the roof structure and whether or not an isolation curb is being provided. When using an isolation curb, consult with the curb manufacturer before selecting spring isolation in the rooftop unit. Doubling or "stacking" spring isolation can generate a resonant vibration.

Indoor Fan and Motor Heat, Blow-Through vs Draw-Through Cooling

Daikin offers blow-through and draw-through cooling coils so the unit can be best selected to match job requirements.

Indoor Fan and Motor Heat

- The indoor fan and motor electrical consumption is a sensible cooling load approximately equal to 2.8 MBh per BHP (depending slightly on motor efficiency). This occurs at the fan. See [Figure 34](#) and [Figure 35](#). The fan and motor preheat the mixed air before it enters a blow-through cooling coil. The fan and motor reheat the air leaving a draw-through cooling coil. Refer also to [2001 ASHRAE Fundamentals Handbook, Chapter 31](#)
- Fan and motor temperature rise is equal to $\text{Btuh}/(1.08 \times \text{cfm})$ and is typically about 3°F
- Due to fan and motor heat placement ([Figure 34](#)), blow-through coils provide a high sensible heat ratio while draw-through coils provide more latent cooling per total ton. Blow-through coils achieve a higher sensible heat ratio because they operate with a higher coil approach temperature and a lower entering relative humidity. Conversely, draw-through coils cool air at a lower approach temperature and a higher relative humidity, increasing latent cooling
- Blow-through coils effectively provide colder supply air temperatures per ton of air conditioning and greater sensible heat ratio. This potentially allows a significant reduction in design cfm for buildings with high sensible heat ratios and a resulting reduction in building energy use

Figure 34: Blow-Through vs. Draw-Through Concept

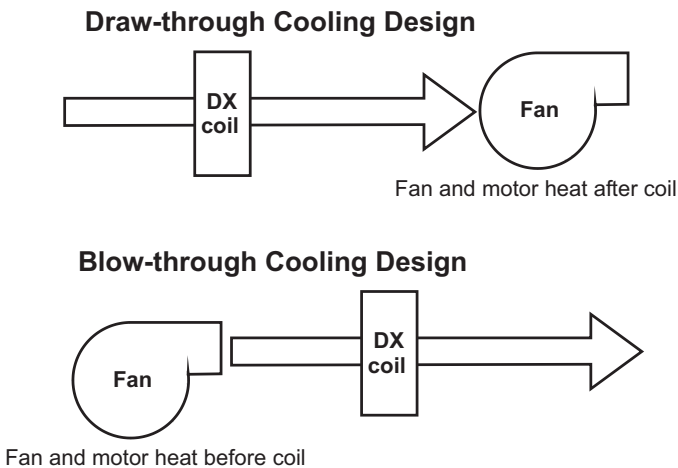
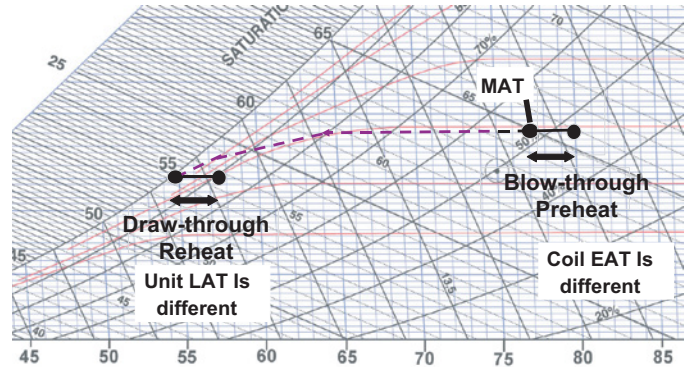

Figure 35: Blow-Through vs. Draw-Through Performance



Draw-Through (available on all units)

In a draw-through unit, the fan is located after the DX cooling coil. In this arrangement, fan heat is applied as reheat to the cold, conditioned air coming off of the coil. This arrangement has a lower sensible heat ratio and higher dehumidification capability than a blow-through coil arrangement. Draw-through arrangements are well suited for 100% outside air applications and applications needing more dehumidification. A draw-through arrangement is mandatory for all applications requiring final filters. The discharge temperature available to the supply duct is always the sum of the coil leaving air temperature plus the fan temperature rise. This must be considered when selecting the supply air volume required to satisfy space requirements.

Example:

55°F leaving coil temperature + 3°F fan temp. rise = 58°F discharge air temperature

Blow-Through (RPS/RFS 035D–140D only)

In a blow-through unit, the fan is located before the DX cooling coil. In this arrangement, fan heat is applied as preheat to the coil. Preheating the air lowers its relative humidity, giving this arrangement a high sensible heat ratio. Blow-through arrangements are well suited for comfort conditioning applications where space heat gains are primarily sensible and the primary latent load is from ventilation air. The discharge temperature available to the supply duct is the coil leaving air temperature.

Altitude Adjustments

Fan curve performance is based on 70°F air temperature and sea level elevation. Selections at any other conditions require the following adjustment for air densities listed in Table 7. Higher elevations generally require more rpm to provide a given static pressure but less bhp due to the decrease in air density.

1. Assume 32,000 cfm is required at 3.11" TSP. The elevation is 5000 ft. and 70°F average air temperature is selected. A 40" DWDI airfoil fan is selected.
2. The density adjustment factor for 5000 ft. and 70°F is 0.83.
3. TSP must be adjusted as follows: $3.11" / 0.83 = 3.75"$.
4. Locate 32,000 cfm and 3.75 on the fan curve (Figure 36). Rpm = 900 and bhp = 27.5. The required fan speed is 900 rpm.
5. The consumed fan power at design = $27.5 \text{ bhp} \times 0.83 = 22.8 \text{ bhp}$.

Table 7: Temperature and Altitude Conversion Factors

Air temp (°F)	Altitude (feet)								
	0	1000	2000	3000	4000	5000	6000	7000	8000
-20	1.20	1.16	1.12	1.08	1.04	1.00	0.97	0.93	0.89
0	1.15	1.10	1.08	1.02	0.99	0.95	0.92	0.88	0.85
20	1.11	1.06	1.02	0.98	0.95	0.92	0.88	0.85	0.82
40	1.06	1.02	0.98	0.94	0.91	0.88	0.84	0.81	0.78
60	1.02	0.98	0.94	0.91	0.88	0.85	0.81	0.79	0.76
70	1.00	0.96	0.93	0.89	0.86	0.83	0.80	0.77	0.74
80	0.98	0.94	0.91	0.88	0.84	0.81	0.78	0.75	0.72
100	0.94	0.91	0.88	0.84	0.81	0.78	0.75	0.72	0.70
120	0.92	0.88	0.85	0.81	0.78	0.76	0.72	0.70	0.67
140	0.89	0.85	0.82	0.79	0.76	0.73	0.70	0.78	0.65

Condenser Performance

Altitudes greater than sea level require a derate in condenser and cooling performance that can be estimated as follows:

- 0 to 6000 feet
 - Cooling capacity decrease factor = 0.5% per 1000 feet
 - Compressor kW increase factor = 0.6% per 1000 feet

The actual derate varies with each individual unit and design conditions. Your local Daikin representative can provide exact performance data.

Furnace Performance

- Gas heat performance data is based on standard 70°F combustion air temperature and zero feet altitude (sea level)
- Furnace altitude derate may be 4% per 1000' above 2000' due to lesser combustion air density
- However, if design ambient is cold enough, then the combined affect of colder temperature and altitude may have an offsetting impact on combustion air density

Example:

A 1000 MBh furnace at 70°F ambient and at an altitude of 5000 feet is derated ($0.04 \times 3 = 0.12$). At 1000 MBh input (1000 - 120 = 880 MBh) at 5000 feet.

- Above 6000 feet, consult factory

Figure 36: RPS 105C to 135C 40" DWDI Airfoil

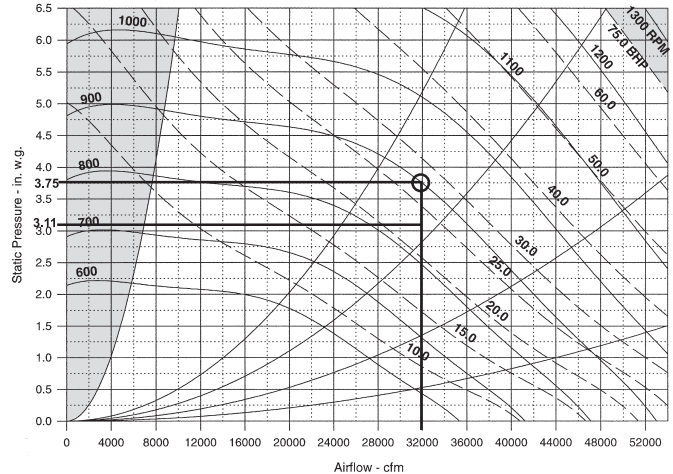

System Operating Limits

Daikin RoofPak systems are designed to operate over an extensive operating range. However, for proper system operation some limits do apply.

To help prevent moisture blow-off, design guidelines have been established for cooling coil selection.

Based on laboratory testing, average coil face velocities should not exceed the following limits:

- 650 ft./min. for 8 & 10 fpi selections
- 600 ft./min. for 12 fpi selections
- For applications outside of these limits, consult your Daikin sales representative. Velocities exceeding these limits not only present the potential for moisture carryover, but also high face velocities generate high air pressure drops, resulting in poor fan energy performance

In addition to maximum face velocity limitations, minimum velocity guidelines must also be followed. In order to maintain proper refrigeration performance, the minimum coil face velocity is 200 ft./min., regardless of coil fin spacing. When selecting a variable air volume unit, it is necessary to design the system such that the 200 ft./min. limit is maintained at light load conditions.

Coil Freeze Protection

When applying roof-mounted equipment in areas that experience subfreezing conditions, coil freeze protection measures must be provided. Subfreezing temperatures can adversely affect water and steam coils during controlled or uncontrolled unit shutdowns and even during unit operation. Daikin RoofPak economizer dampers are arranged to direct the outside and return air streams in multiple mixing patterns, minimizing air stratification. Even though this is one of the most effective mixing arrangements available, there may not always be a uniform unit temperature profile under all load and ambient temperatures. Some temperature stratification will occur, particularly at low ambient temperatures and the associated reduced airflow inherent with VAV systems. When required, static air mixers/blenders are available that can significantly improve mixing and reduce stratification. This can result in improved protection against freeze-up.

Glycol is strongly recommended as a positive means of freeze protection for water coils. No control sequence can prevent coil freezing in the event of a power failure or equipment malfunction. During those periods, glycol is the only positive means of freeze protection. When selecting water coils, specify glycol to account for performance differences.

An optional non-averaging freezestat equipment protection control can be provided, located downstream of the heating coil. If a potential freezing condition is sensed, a sequence is initiated by the unit control system, closing outdoor air dampers, opening the heating valve and deenergizing the fan. The freezestat setting should be some increment higher than freezing to provide an added margin of protection. The use of a freezestat control may cause nuisance trips. It cannot prevent freeze-up in the event of power failure or equipment malfunction.

Freeze protection control strategies must be designed to keep unit cabinet temperatures from exceeding 150°F during a unit shutdown. Temperatures in excess of 150°F may exceed the design limits of motors, electrical components, gaskets, etc. potentially leading to premature failure of components.

Piping and Condensate Drainage

Always follow good industry practice in the design of the water piping system. Do not apply undue stress at the connection to coil headers. In addition, support piping independently from the coils with adequate piping flexibility for thermal expansion.

Provide all drain pans with a properly sized p-trap to allow free drainage of coil condensate. Provide traps to prevent cabinet static pressure from leaking air at the drain line in blow-through coil applications. For draw-through coil applications, a properly sized and installed trap is essential to allow for proper condensate drainage. An improper trap could cause condensate to build up in the drain pan and overflow into the unit. For trap sizing, follow instruction given in [IM 485](#). Run all traps and drain lines full size from the threaded unit connection to the roof drain.

Units providing steam heat must be installed level to provide proper drainage and adequate steam pressure at the steam valve and coil. Condensate must be properly trapped with vacuum breakers installed on the coil (See [Figure 37](#)). For steam piping recommendations, see Daikin [Steam Coil Catalog 413](#).

Figure 37: Drain Pan Traps

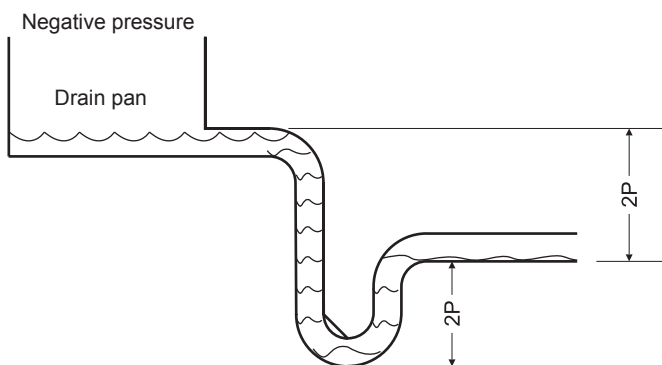

Zone Sensor Placement

Placement of the zone temperature sensor is critical for proper and economical operation of the heating and cooling system. It is generally recommended that the space sensor be located on an inside wall (3 to 5 feet from an outside wall) in a space having a floor area of at least 400 square feet. Do not locate the sensor below the outlet of a supply diffuser, in the direct rays of the sun, on a wall adjacent to an unheated or abnormally warm room (boiler or incinerator room), or near any heat producing equipment. Where zone sensor placement is a problem, all zone control systems, as standard, have the capability to use a return air sensor for heating and cooling.

Unit Wiring

All units require three phase, 60 Hz, 208, 230, 460 or 575 volt power or three phase, 50 Hz, 400 volt power. Units do not operate satisfactorily at $\pm 10\%$ of rated voltage, at the power connections to the units. All units include branch circuit, short circuit protection and are available with one or multiple power blocks or non-fused disconnect switches. Each unit is provided with a 115-volt convenience outlet circuit. Per the NEC, this circuit must be fed independent of the main unit power supply.

All wiring must be installed in accordance with the National Electric Code (NEC) and local codes.

Condenser Coil Protection

If the Rooftop is installed in a corrosive environment, such as near a sea coast, Daikin recommends the optional e-coated condenser coils. Copper fin or e-coated DX coil options should also be considered.

Winter Shipment

Flat bed shipment in winter can expose units to harsh road chemicals. Since equipment size and configuration precludes covering during transit, wash units free of these chemicals as soon as possible to help prevent corrosion.

Achieving the optimal performance of a rooftop system requires both accurate system design and proper equipment selection. Factors that control the unit selection include applicable codes, ventilation and air filtration requirements, heating and cooling loads, acceptable temperature differentials, and installation limitations. Daikin RoofPak units offer a wide selection of component options providing the capability to meet diverse application requirements.

The Daikin SelectTools™ software selection program allows your local Daikin sales representative to provide you with fast, accurate and complete selection of Daikin RoofPak units. You also can select your unit through reference to physical, performance, dimensional, and unit weight data included in this catalog. Due to the variety of cooling coil options available, only a sample of cooling capacity data is presented in the catalog.

To properly select unit equipment:

1. Select unit size and cooling coil.
2. Select heating coils and equipment.
3. Select fans and motors.

Below are examples that illustrate the equations and catalog references used in the unit selection process.

Selection Example

A constant volume system with DX cooling and natural gas heat is required to meet the following criteria:

Supply air volume	= 22,000 cfm
Return air volume	= 20,000 cfm
Minimum outside air volume	= 2000 cfm
Maximum face velocity	= 560 fpm
Supply fan external SP	= 2.60-in. w.g.
Return fan external SP	= 1.00-in. w.g.
Altitude	= Sea level
Economizer with return air fan	= Required
30% throw-away filters	= Required
Voltage	= 460V/60Hz/3Ph
Fully modulating gas heat	= Required
Double-wall construction	= Required

Summer design:

Mixed air temperature	= 80°F/67°F
Blow-through Coil entering temperature	= 83°F/67.9°F (80°F/67°F + fan Dt)
Total sensible load	= 640,000Btu/hr
Total load	= 780,000 Btu/hr
Space supply air temperature	= 53.5°F
Ambient conditions	= 95°F/76°F
Est. supply fan sensible heat rise	= 3°F
(included in above sensible load)	

Winter design:

Return air temperature	= 70°F
Ambient temperature	= 10°F
Space heating load	= 450,000 Btu/hr

Selecting Unit Size to Satisfy Summer Design

Unit size is based on coil face area and cooling capacity requirements. Supply air capacity and maximum face velocity constraints should serve as a guide for selecting coil dimensions and cabinet size. Many model sizes are available with a standard and a high airflow coil selection. This flexibility prevents the need to increase cabinet size to accommodate high airflow per ton applications.

Based on the given data, the appropriate coil face area may be determined as follows:

$$\begin{aligned} \text{Minimum face area} &= \text{supply air volume}/\text{maximum face velocity} \\ &= 22,000 \text{ cfm}/550 \text{ fpm} \\ &= 39.3 \text{ square feet} \end{aligned}$$

NOTE: Unit data is based on standard air conditions of 70°F at sea level. Refer to [Application Considerations on page 33](#) for temperature/altitude conversion factors for nonstandard conditions.

Referring to [Physical Data on page 43](#), the 39.5 square foot, small face area coil of the RPS 045D to 075D units satisfies the required face velocity.

The unit selection is an RPS 070D with a small face area, 5-row, 10 fins/inch DX coil. Unit performance equals 792,000 Btu/hr. total, 626,000 Btu/hr. sensible by interpolation.

$$\text{Supply air dry bulb} = 83^\circ\text{F} - 626 \text{ MBh}/(1.085 \times 22,000 \text{ cfm}) = 53.2^\circ\text{F}$$

Once the initial unit selection is made, determine the actual supply fan heat rise and check and verify the selection for net capacity and supply air temperature.

Selecting the Unit Heating System

Heating equipment and coils can be specified directly from figures and tables incorporated in [Heating Capacity Data on page 47](#).

Calculating Total Heating Load

$$\text{Total heating load} = \text{space heating load} + \text{outdoor air load} - \text{supply fan heat}$$

From the data given, the outdoor air load is $(1.085)(4000)(70 - 10) / 1000 = 260 \text{ MBh}$ and supply fan heat is 65 MBh. Total heat load = 450 MBh + 260 MBh – 65 MBh = 645 MBh

Gas Heat: When selecting a gas furnace, the system heating load, minimum airflow and maximum temperature rise constraints are needed. Refer to [Figure 38 on page 47](#) for furnace model size selection. Enter the graph at 20,000 cfm and move up vertically to the intersection of 602 MBh output. In this example, the intersection of Minimum cfm and MBh Output occurs between model lines. Therefore, the larger model size, Model 640, should be selected for adequate heating.

For all heat exchangers, there exists a maximum temperature rise. This limitation is determined by the heat exchanger surface area to airflow ratio. Refer to [Table 12 on page 47](#) for verification of the temperature rise capability of the furnace selected. Also, use this table when specifying baffle position based on minimum airflow design. Refer to [Altitude Adjustments on page 37](#).

NOTE: In VAV applications, consider range of airflow modulation when selecting furnace model and baffle position.

Electric Heat: Referring to the [Electric Heat on page 14](#) for the RPS 070D, the design load of 645 Mbh falls between heater models 200 and 240. The Model 240 heater would be chosen to satisfy the design conditions.

Selecting Fans and Motors

Fan and motor selections are based on total static pressure drop and design airflow. Total static pressure includes internal air pressure drops of unit components and external air pressure drops in supply and return ducts. Refer to [Component Pressure Drops on page 56](#) for internal pressure drops of unit components.

When selecting unit fans and motors, use the fan curves provided in [Fan Performance Data—Supply Fans on page 60](#) and [Fan Performance Data—Propeller Exhaust Fans on page 68](#)

Careful consideration is needed in regards to return duct ESP:

- RAF system - The RAF handles return ESP at design.
- EAF system - The SAF handles return ESP at design.

See [page 35](#) for details.

To optimize fan performance, select the fan size having design airflow and static pressure intersecting as close to the first system curve as possible after the shaded Do Not Select region. Refer to [Application Considerations on page 33](#).

Select the motor size as close below the horsepower curve as possible to the actual bhp requirements to prevent motor oversizing. An oversized motor (large horsepower to load ratio) can greatly increase electric consumption due to the reduction in motor performance.

Return Fan and Motor

Select an economizer with a return fan for the given system. A return (or exhaust fan) system is often necessary for maintaining proper pressure in a building. See [Application Considerations on page 33](#) for more information on the economizer and return fan application.

Use the external air pressure drop of the return duct along with the design return airflow to select a return fan. Based on [Figure 79 on page 71](#), the return fan size is 40 inches and the bhp = 6.5. The required fan motor size is 7.5 hp.

Exhaust Fan and Motor

Exhaust fans must be sized for maximum exhaust cfm and return duct ESP at those conditions. See [Fan Performance Data—Propeller Exhaust Fans on page 68](#) for more information.

Supply Fan and Motor

Since this system includes a return fan, the return duct static pressure drop is not added to the supply fan pressure drop. Therefore, the total static pressure for the supply fan in the example is as follows:

Internal pressure drops (from [Table 25 on page 57](#)):

- 0–100% economizer, with RAF = 0.38-in. w.g.
- 30% angular filters = 0.16-in. w.g.
- Gas furnace = 0.24-in. w.g.
- Evaporative coil (small 5-row, 10 fpi) = 0.79-in. w.g.
- Total internal pressure drop = 1.57-in w.g.**

External pressure drops:

- Supply duct = 2.60-in. w.g.
- Total external pressure drop = 2.60-in w.g.
- Total static pressure = internal drops + external drops
- = 1.57 + 2.60
- = 4.17-in. w.g.

NOTE: When gas or electric heat is provided, do not add the cooling coil diffuser pressure drop. In VAV applications with gas heat, consult your Daikin sales representative for design pressure drop determinations.

For a constant volume system a forward curve or airfoil type fan can be selected. Reference [Application Considerations on page 33](#) for discussion on acoustical consideration. Considering its favorable brake horsepower, an airfoil type fan is selected.

Entering the standard 30-in. airfoil fan curve (see [Figure 65 on page 63](#)) at 20,000 cfm and 4.08-in. w.g., the required fan motor size is 25 hp. Fan brake horsepower is 21.2 horsepower.

The total fan and motor heat for the supply and return fan is as follows:

$$(6.5 + 21.2) \text{ bhp} \times 2.8 \text{ MBh/bhp} = 78 \text{ MBh}$$

Supply Power Wiring for Units without Electric Heat

Sizing supply power wire for a unit is based on the circuit with the largest amperage draw. All electrical equipment is wired to a central panel for single or optional multipower connections. Refer to [Electrical Data on page 97](#) for FLA and RLA ratings of equipment. Determination of Minimum Circuit Ampacity (MCA) for a 460-volt unit with standard condenser fans is as follows:

Fans and Cooling:

$$\text{MCA} = 1.25 \times \text{RLA or FLA of largest motor} + 1.00 \times \text{FLA of other loads}$$

Example FLA/RLA

- Compressors (6) = 17.9 amps ea.
- Condenser fan motors, (6) 1 hp = 2 amps ea.
- Supply fan motor, 25 hp = 31 amps
- Return fan motor, 7.5 hp = 10.8 amps

Therefore,

$$\text{MCA} = 1.25 \times 17.9 + [(17.9) (5) + (6)2 + 31 + 10.8] = 165.7 \text{ amps}$$

Select power supply wire based on 165.7 amperes.

Supply Power Wiring for Units with Electric Heat

When selecting units with nonconcurring electric heat, MCA must be calculated for both the cooling mode and the heating mode, and then the greater of the two used.

For heating:

$$\begin{aligned} \text{MCA} &= 1.25 [\text{FLA of electric heater} + \text{FLA of all other loads}] \\ &= 1.25 \times [287.2 + 31 + 10.8] \\ &= 409 \text{ amps} \end{aligned}$$

For cooling:

$$\text{MCA} = 165.7 \text{ amps}$$

The controlling load is when in the electric heat mode. Unit MCA = 409 amps.

Calculating Unit Length

Referring to unit [Dimensional Data on page 72](#) for a blow-through RPS 061D, [Figure 85 on page 75](#):

$$\begin{aligned} \text{Total unit length} &= \text{economizer w/RAF} + \text{angular filter fan section} + \\ &\quad \text{heat section} + \text{DX coil section} + \text{discharge plenum} + \\ &\quad \text{condensing unit} \\ &= 72 \text{ in.} + 24 \text{ in.} + 72 \text{ in.} + 48 \text{ in.} + 24 \text{ in.} + 48 \text{ in.} + 83 \text{ in.} \\ &= 371 \text{ inches.} \end{aligned}$$

NOTE: When selecting unit curb length, do not include the length of the condensing unit.

Calculating Unit Weight

Referring to unit [Unit Weights on page 102](#) for a RPS 070D, [Table 45 on page 102](#):

$$\begin{aligned} \text{Total unit weight} &= \text{RPS basic unit} + \text{economizer} + 30\% \text{ filters} + \\ &\quad 30" \text{ AF SAF} + 40" \text{ AF RAF} + 5\text{-row, } 12 \text{ fpi Al. fin small} \\ &\quad \text{face area coil} + 640 \text{ MBh gas furnace} + \text{SAF motor} + \\ &\quad \text{RAF motor} + \text{cabinet liners} \\ &= 7580 + 1065 + 4 + 965 + 629 + 600 + 428 + 266 + \\ &\quad 82 + (25 \times 288/12) \\ &= 12,215 \text{ lbs.} \end{aligned}$$

Table 8: Physical data, Sizes 015D to 042D

Data		Unit Size					
		015/016D ^f	020/020D ^f , 021D ^a /021D ^f	025/025D ^f , 026D ^a /026D ^f	030/031D ^f	035/035D ^f	042D/42D ^f
Compressor ^c	Quantity–hp	2–7	1–10, 2–4.5	1–11.5, 2–5.5	1–13, 2–6	4–7.5	4–8.5
	Capacity control	100-50-0	100-78-44-22-0	100-78-44-22-0	100-78-44-22-0	100-75-50-25-0	100-75-50-25-0
Compressor ^f	Quantity/Type	(1) Variable Speed compressor & (1) Fixed Speed				(1) Variable & (2) Fixed Speed Compressors	
	Capacity control	Modulating	Modulating	Modulating	Modulating	—	Modulating
	Unit Capacity Steps %	20–100	15–100	15–100	17–100	—	13–100
	Number of circuits	2	2	2	2	—	2
Condenser fans	Qty–diameter (in)	2–26	2–26	2–26	4–26	4–26	4–26
Condenser fan motors	Qty–hp	2–1.0	2–1.0	2–1.0	4–1.0	4–1.0	4–1.0
Supply fans	Type	Forward curved LP				Forward curved LP/MP	
	Qty–diameter (in)	2–15×6*	2–15×6*	2–15×6*	2–15×6*	1–24	1–24
	Qty–diameter (in)	2–15×15	2–15×15	2–15×15	2–15×15	—	—
	Airflow range (cfm)	4000–12000	4000–12000	5400–16000	5400–16000	5400–17550	5400–17550
	Motor hp range	1–20	1–20	1–20	1–20	1–25	1–25
	Type	DWDI airfoil					
	Qty–diameter (in)	1–20	1–20	1–20	1–20	1–24	1–24
	Motor hp range	1–20	1–20	1–20	1–20	1–25	1–25
Return fans	Type	Forward curved					
	Diameter (in)	2–15×15	2–15×15	2–15×15	2–15×15	—	—
	Airflow range (cfm)	4000–10000	4000–12000	5400–16000	5400–16000	—	—
	Motor hp range	1–10	1–10	1–10	1–10	—	—
	Type	SWSI airfoil					
	Qty–diameter (in)	1–30	1–30	1–30	1–30	1–30, 1–40	1–30, 1–40
	Motor hp range	1–10	1–10	1–10	1–10	1–10	1–10
Evaporator coils	Standard F.A. (sq ft)	18.5	18.5	—	—	—	—
	Large F.A. (sq ft)	—	—	27.0	27.0	27.0	27.0
Hot water coils	Type–rows	5WH–1	5WH–1	5WH–1	5WH–1	5WH–1	5WH–1
	Type–rows	5WS–2	5WS–2	5WS–2	5WS–2	5WS–2	5WS–2
	FPI	9	9	9	9	9	9
	Face area (sq ft)	20.3	20.3	20.3	20.3	20.3	20.3
Steam coils	Type–rows	5JA–1	5JA–1	5JA–1	5JA–1	5JA–1	5JA–1
	FPI	6, 12	6, 12	6, 12	6, 12	6, 12	6, 12
	Face area (sq ft)	20.3	20.3	20.3	20.3	20.3	20.3
Gas furnace	Input (MBh)	250, 312, 400, 500, 625, 800, 812, 988, 1000, 1250					
	Nom. output (MBh)	200, 250, 320, 400, 500, 640, 650, 790, 800, 1000					
Electric heat	Nom. output (kW)	20, 40, 60, 80, 100, 120, 140, 160, 180, 200, 220, 240					
Panel filters	Type	85% or 30% pleated					
	Area (sq ft)	50.0	50.0	50.0	50.0	50.0	50.0
	Qty–size (in)	10–16×20×2 10–16×25×2	10–16×20×2 10–16×25×2	10–16×20×2 10–16×25×2	10–16×20×2 10–16×25×2	10–16×20×2 10–16×25×2	10–16×20×2 10–16×25×2
Prefilters (for cartridge filters)	Type	Prefilter, standard low					
	Area (sq ft)	24.0	24.0	24.0	24.0	24.0	24.0
	Qty–size (in)	4–24×24×2 4–12×24×2	4–24×24×2 4–12×24×2	4–24×24×2 4–12×24×2	4–24×24×2 4–12×24×2	4–24×24×2 4–12×24×2	4–24×24×2 4–12×24×2
Cartridge filters	Type	65% or 95%, standard low					
	Area (sq ft)	24.0	24.0	24.0	24.0	24.0	24.0
	Qty–size (in)	4–24×24×12 4–12×24×12	4–24×24×12 4–12×24×12	4–24×24×12 4–12×24×12	4–24×24×12 4–12×24×12	4–24×24×12 4–12×24×12	4–24×24×12 4–12×24×12

* 100% OA only.

a. Gas furnace size availability is limited by minimum airflow. See Table 12 on page 47.

b. 460-volt capacities are shown. Electric heat availability is limited by minimum airflow. See Table 15 through Table 17.

c. Compressor information for units with fixed speed compressors only.

d. Premium efficiency model number.

f. Units model number and compressor information with variable speed compressors.

Table 9: Physical Data, Sizes 045D to 079D

Data		Unit size						
		045D ^d /045D ^f	050/050 ^f /051D ^{d,f}	061/063D ^{d,f}	068D	070/071D ^d	075D/074D ^{d,f}	079D
Compressor ^c	Quantity—hp	4—10	4—11.5	4—13	4—15	6—10	6—11.5	3-11.5/3-13
	Capacity control	100-75-50-25-0				100-83-67-50-33-17-0		
Compressor ^f	Quantity/ Type	(1) Variable Speed compressor & (2) Fixed Speed			—	—	(1) Variable & (3) Fixed Speed Compressors	—
	Capacity control	Modulating	Modulating	Modulating	—	—	Modulating	—
	Unit Capacity Steps %	16-100	16-100	14-100	—	—	11-100	—
	Number of circuits	2	2	2	—	—	2	—
Condenser fans	Qty—diameter (in)	4—26	4—26	6—26	6—26	6—26	8—26	8—26
Condenser fan motors	Qty—hp	4—1.0	4—1.0	6—1.0	6—1.0	6—1.0	8—1.0	8—1.0
	Type	DWDI airfoil						
RPS supply fans	Qty—diameter (in)	1—30, 33	1—30, 33	1—30, 33	1—30, 33	1—30, 33	1—30, 33	1—30, 33
	Motor hp range	3—50	3—50	3—50	3—50	3—50	3—50	3—50
RDT supply fans	Type	SWSI airfoil						
	Qty—diameter (in)	1—40,44	1—40,44	1—40,44	1—40,44	1—40,44	1—40,44	1—40,44
Return fans	Motor hp range	3—50	3—50	3—50	3—50	3—50	3—50	3—50
	Type	SWSI airfoil						
Exhaust fans	Qty—diameter (in)	1—40	1—40	1—40	1—40	1—40	1—40	1—40
	Motor hp range	2—30	2—30	2—30	2—30	2—30	2—30	2—30
	Type	Propeller						
Evaporator coils	Diameter (in)	36	36	36	36	36	36	36
	Quantity	1 or 2 per unit	1 or 2 per unit	1 or 2 per unit	1 or 2 per unit	1 or 2 per unit	1 or 2 per unit	1 or 2 per unit
	Motor hp	5 each	5 each	5 each	5 each	5 each	5 each	5 each
Hot Water coils	Standard F.A. (sq ft)	39.5	39.5	39.5	39.5	39.5	39.5	39.5
	Large F.A. (sq ft)	—	47.1	47.1	47.1	47.1	47.1	47.1
Steam coils	Type—rows	5WH—1	5WH—1	5WH—1	5WH—1	5WH—1	5WH—1	5WH—1
	FPI	5WS—2	5WS—2	5WS—2	5WS—2	5WS—2	5WS—2	5WS—2
	Face area (sq ft)	9	9	9	9	9	9	9
Gas furnace	Type—rows	29.7	29.7	29.7	29.7	29.7	29.7	29.7
	FPI	5JA—1, 2	5JA—1, 2	5JA—1, 2	5JA—1, 2	5JA—1, 2	5JA—1, 2	5JA—1, 2
	Face area (sq ft)	6, 12	6, 12	6, 12	6, 12	6, 12	6, 12	6, 12
Electric heat	Input (MBh)	250, 312, 400, 500, 625, 800, 812, 988, 1000, 1250						
	Nom. output (MBh)	200, 250, 320, 400, 500, 640, 650, 790, 800, 1000						
Panel filters	Nom. output (kW)	40, 60, 80, 100, 120, 160, 200, 240						
	Type	85% or 30% pleated						
	Area (sq ft)	73.9	73.9	73.9	73.9	73.9	73.9	73.9
Prefilters (for cartridge filters)	Qty—size (in)	7—16×20×2 21—16×25×2	7—16×20×2 21—16×25×2	7—16×20×2 21—16×25×2	7—16×20×2 21—16×25×2	7—16×20×2 21—16×25×2	7—16×20×2 21—16×25×2	7—16×20×2 21—16×25×2
	Type	Prefilter, standard low						
	Area (sq ft)	40.0	40.0	40.0	40.0	40.0	40.0	40.0
	Qty—size (in)	4—12×24×2 8—24×24×2	4—12×24×2 8—24×24×2	4—12×24×2 8—24×24×2	4—12×24×2 8—24×24×2	4—12×24×2 8—24×24×2	4—12×24×2 8—24×24×2	4—12×24×2 8—24×24×2
Cartridge filters	Type	Prefilter, medium low						
	Area (sq ft)	48.0	48.0	48.0	48.0	48.0	48.0	48.0
	Qty—size (in)	8—12×24×2 8—24×24×2	8—12×24×2 8—24×24×2	8—12×24×2 8—24×24×2	8—12×24×2 8—24×24×2	8—12×24×2 8—24×24×2	8—12×24×2 8—24×24×2	8—12×24×2 8—24×24×2
	Type	65% or 95%, standard low						
Cartridge filters	Area (sq ft)	40.0	40.0	40.0	40.0	40.0	40.0	40.0
	Qty—size (in)	4—12×24×12 8—24×24×12	4—12×24×12 8—24×24×12	4—12×24×12 8—24×24×12	4—12×24×12 8—24×24×12	4—12×24×12 8—24×24×12	4—12×24×12 8—24×24×12	4—12×24×12 8—24×24×12
	Type	65% or 95%, medium low						
	Area (sq ft)	48.0	48.0	48.0	48.0	48.0	48.0	48.0
Cartridge filters	Qty—size (in)	8—12×24×12 8—24×24×12	8—12×24×12 8—24×24×12	8—12×24×12 8—24×24×12	8—12×24×12 8—24×24×12	8—12×24×12 8—24×24×12	8—12×24×12 8—24×24×12	8—12×24×12 8—24×24×12

a. Gas furnace size availability is limited by minimum airflow. See Table 12 on page 47.
 b. 460-volt capacities are shown. Electric heat availability is limited by minimum airflow. See Table 15 through Table 17.
 c. Compressor information for units with fixed speed compressors only.
 d. Premium efficiency model number.
 f. Units model number and compressor information with variable speed compressors.

Table 10: Physical Data, Sizes 080D to 105D

Data		Unit size				
		080/081D	085D	090/091D	100/101D	105D
Compressor	Quantity—hp	6—11.5	6—13	6—13	3—13 3—15	6—15
	Std. capacity control	100-83-67-50-33-17-0			100-83-67-49-33-16-0	100-84-67-50-33-17-0
Condenser fans	Qty—diameter (in)	6—26	6—26	8—26	9—26	8—26
Condenser fan motors	Qty—hp	6—1.0	6—1.0	8—1.0	9—1.0	8—1.0
Supply fans	Type	DWDI airfoil				
	Qty—diameter (in)	1—33, 36	1—33, 36	1—33, 36	1—36, 40	1—36, 40
	Motor hp range	5—75	5—75	5—75	5—75	5—75
RDT supply fans	Type	SWSI airfoil				
	Qty—diameter (in)	1—44, 49				
	Motor hp range	5—75				
Return fans	Type	SWSI airfoil				
	Qty—diameter (in)	1—44.5	1—44.5	1—44.5	1—44.5	1—44.5
	Motor hp range	5—60	5—60	5—60	5—60	5—60
Exhaust fans	Type	Propeller				
	Diameter (in)	36	36	36	36	36
	Quantity	1—3 per unit	1—3 per unit	1—3 per unit	1—3 per unit	1—3 per unit
	Motor hp	5 each	5 each	5 each	5 each	5 each
Evaporator coils	Standard F.A. (sq ft)	53.9	53.9	53.9	60.8	60.8
	Large F.A. (sq ft)	60.8	60.8	60.8	76.0	76.0
Hot water coils	Type—rows	5WH—1 5WS—2	5WH—1 5WS—2	5WH—1 5WS—2	5WH—1 5WS—2	5WH—1 5WS—2
	FPI	9	9	9	9	9
	Face area (sq ft)	42.2	42.2	42.2	42.2	42.2
	Type—rows	5JA—1, 2	5JA—1, 2	5JA—1, 2	5JA—1, 2	5JA—1, 2
Steam coils	FPI	6, 12	6, 12	6, 12	6, 12	6, 12
	Face area (sq ft)	42.2	42.2	42.2	42.2	42.2
	Type—rows	5JA—1, 2	5JA—1, 2	5JA—1, 2	5JA—1, 2	5JA—1, 2
Gas furnace	Input (MBh)	625, 800, 812, 988, 1000, 1250, 1375, 1750, 1875, 2500				
	Nom. output (MBh)	500, 640, 650, 790, 800, 1000, 1100, 1400, 1500, 2000				
Electric heat	Nom. output (kW)	80, 100, 120, 160, 200, 240, 280, 320				
Panel filters	Type	85% or 30% pleated				
	Area (sq ft)	116.1	116.1	116.1	116.1	116.1
	Qty—size (in)	11—16×20×2 33—16×25×2	11—16×20×2 33—16×25×2	11—16×20×2 33—16×25×2	11—16×20×2 33—16×25×2	11—16×20×2 33—16×25×2
Prefilters (for cartridge filters)	Type	Prefilter, standard flow			Prefilter, medium flow	
	Area (sq ft)	56.0	56.0	56.0	64.0	64.0
	Qty—size (in)	4—12×24×2 12—24×24×2	4—12×24×2 12—24×24×2	4—12×24×2 12—24×24×2	16—24×24×2	16—24×24×2
	Type	Prefilter, medium flow		Prefilter, high flow		
	Area (sq ft)	64.0	64.0	64.0	80.0	80.0
	Qty—size (in)	16—24×24×2	16—24×24×2	16—24×24×2	8—12×24×2 16—24×24×2	8—12×24×2 16—24×24×2
Cartridge filters	Type	65% or 95% standard flow			65% or 95% medium flow	
	Area (sq ft)	56.0	56.0	56.0	64.0	64.0
	Qty—size (in)	4—12×24×12 12—24×24×12	4—12×24×12 12—24×24×12	4—12×24×12 12—24×24×12	16—24×24×12	16—24×24×12
	Type	65% or 95% medium flow			65% or 95% high flow	
	Area (sq ft)	64.0	64.0	64.0	80.0	80.0
	Qty—size (in)	16—24×24×12	16—24×24×12	16—24×24×12	8—12×24×12 16—24×24×12	8—12×24×12 16—24×24×12

a. Gas furnace size availability is limited by minimum airflow, See Table 12 on page 47.

b. 460-volt capacities are shown. Electric heat availability is limited by minimum airflow, See Table 15 through Table 17..

Table 11: Physical Data, Sizes 110D to 140D

Data		Unit size				
		110D	120D	125D	130D	140D
Compressor	Quantity—hp	6—15	3—15 3—20	6—20	6—20	3—20 3—25
	Std. capacity control	100-84-67-50-33-17-0				100-83-67-49-33-16-0
Condenser fans	Qty—diameter (in)	8—26	9—26	10—26	12—26	12—26
Condenser fan motors	Qty—hp	8—1.0	9—1.0	10—1.0	12—1.0	12—1.0
Supply fans	Type	DWDI airfoil				
	Qty—diameter (in)	1—36, 40	1—36, 40	1—36, 40	1—36, 40	1—36, 40
	Motor hp range	5—75	5—75	5—75	5—75	5—75
RDT supply fan	Type	SWSI airfoil				
	Qty—diameter (in)	1—44, 49				
	Motor hp range	5—75				
Return fans	Type	SWSI airfoil				
	Qty—diameter (in)	1—44.5	1—44.5	1—44.5	1—44.5	1—44.5
	Motor hp range	5—60	5—60	5—60	5—60	5—60
Exhaust fans	Type	Propeller				
	Diameter (in)	36	36	36	36	36
	Quantity	1—3 per unit	1—3 per unit	1—3 per unit	1—3 per unit	1—3 per unit
	Motor hp	5 each	5 each	5 each	5 each	5 each
Evaporator coils	Standard F.A. (sq ft)	60.8	60.8	—	—	—
	Large F.A. (sq ft)	76.0	76.0	76.0	76.0	76.0
Hot water coils	Type—rows	5WH—1 5WS—2	5WH—1 5WS—2	5WH—1 5WS—2	5WH—1 5WS—2	5WH—1 5WS—2
	FPI	9	9	9	9	9
	Face area (sq ft)	42.2	42.2	42.2	42.2	42.2
	Type—rows	5JA—1, 2	5JA—1, 2	5JA—1, 2	5JA—1, 2	5JA—1, 2
Steam coils	FPI	6, 12	6, 12	6, 12	6, 12	6, 12
	Face area (sq ft)	42.2	42.2	42.2	42.2	42.2
	Type—rows	5JA—1, 2	5JA—1, 2	5JA—1, 2	5JA—1, 2	5JA—1, 2
Gas furnace	Input (MBh)	625, 800, 812, 988, 1000, 1250, 1375, 1750, 1875, 2500				
	Nom. output (MBh)	500, 640, 650, 790, 800, 1000, 1100, 1400, 1500, 2000				
Electric heat	Nom. output (kW)	80, 100, 120, 160, 200, 240, 280, 320				
Panel filters	Type	85% or 30% pleated				
	Area (sq ft)	116.1	116.1	116.1	116.1	116.1
	Qty—size (in)	11—16×20×2 33—16×25×2	11—16×20×2 33—16×25×2	11—16×20×2 33—16×25×2	11—16×20×2 33—16×25×2	11—16×20×2 33—16×25×2
Prefilters (for cartridge filters)	Type	Prefilter, standard flow		Prefilter, medium flow		
	Area (sq ft)	64.0	64.0	64.0	64.0	64.0
	Qty—size (in)	16—24×24×2	16—24×24×2	16—24×24×2	16—24×24×2	16—24×24×2
	Type	Prefilter, medium flow		Prefilter, high flow		
	Area (sq ft)	80.0	80.0	80.0	80.0	80.0
	Qty—size (in)	8—12×24×2 16—24×24×2	8—12×24×2 16—24×24×2	8—12×24×2 16—24×24×2	8—12×24×2 16—24×24×2	8—12×24×2 16—24×24×2
Cartridge filters	Type	65% or 95% standard flow		65% or 95% medium flow		
	Area (sq ft)	64.0	64.0	64.0	64.0	64.0
	Qty—size (in)	16—24×24×12	16—24×24×12	16—24×24×12	16—24×24×12	16—24×24×12
	Type	65% or 95% medium flow		65% or 95% high flow		
	Area (sq ft)	80.0	80.0	80.0	80.0	80.0
	Qty—size (in)	8—12×24×12 16—24×24×12	8—12×24×12 16—24×24×12	8—12×24×12 16—24×24×12	8—12×24×12 16—24×24×12	8—12×24×12 16—24×24×12

a. Gas furnace size availability is limited by minimum airflow, See Table 12 on page 47.

b. 460-volt capacities are shown. Electric heat availability is limited by minimum airflow, See Table 15 through Table 17.

Gas Heat

Figure 38: Gas Heat Capacity

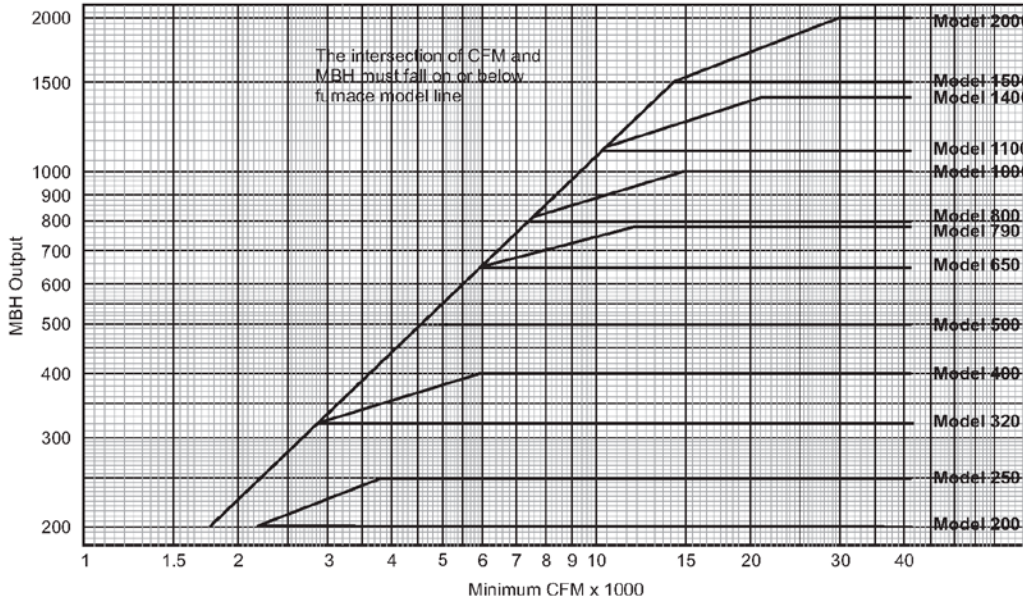

Table 12: Gas Furnace Design Maximum Air Temperature Rise (°F) and Minimum Airflow

Baffle Position	Maximum Temperature Rise (°F)—Minimum Airflow (cfm)—Furnace Size (MBh)												
	Column Number For Pressure Drop (see Table 61 on page 74).												
	200	250	320	400	500	650	790	800	1000	1100	1400	1500	2000
A	80	61	100	61	100	100	61	100	61	100	61	100	61
	2300	3800	2950	6000	4600	5970	12000	7340	15000	10100	21000	13700	30000
	1	1	1	1	2	3	3	3	3	4	4	7	7
B	62	42	78	35	63	73	52	76	50	73	34	82	49
	3000	5500	3800	10500	7400	8200	14000	9800	18500	14000	38000	17000	38000
	4	4	4	4	5	4	4	4	4	6	6	8	8
C	46	15	59	31	55	65	46	71	40	64	33	73	40
	4000	15000	5000	12000	8400	9200	16000	10400	23000	16000	39000	19000	46000
	9	9	9	9	10	10	10	10	10	10	10	10	10

Note:
 Temperature rise and airflow limit applicable to all burner types.
 VAV application, consider the minimum turndown airflow when selecting baffle position.
 Furnace Availability:
 200–1000 MBh output furnaces available in RPS/RFS sizes 015D–079D.
 500–2000 MBh output furnaces available in RPS/RFS sizes 080D–140D

Table 13: Gas Burner Connection Size (inches)

Description	Furnace Size (MBh Output)												
	200	250	320	400	500	650	790	800	1000	1100	1400	1500	2000
Natural Gas (CFH)	250	312	400	500	625	812	1000	1000	1250	1375	1750	1875	2500
Minimum Gas Inlet Pressure (in. W.C.)	Standard Burner	6.00	6.00	7.00	7.00	7.00	7.00	7.50	7.50	9.00	7.00	8.00	9.00
	20:1 Burner	4.50	5.50	6.00	5.00	5.50	7.00	6.50	6.50	6.50	5.00	5.00	6.00
Gas Pipe Connection Size (N.P.T.)	Through 0.5 psi	0.75	0.75	0.75	1.00	1.00	1.25	1.25	1.25	1.25	1.50	1.50	2.00
	2–3 psi	0.75	0.75	0.75	1.00	1.00	1.25	1.25	1.25	1.25	1.25	1.25	1.50
	5–10 psi	0.75	0.75	0.75	1.00	1.00	1.25	1.25	1.25	1.25	1.25	1.25	1.25

Table 14: Gas Furnace Inlet Pressure Range

Regulator	Furnace Model Number												
	200	250	320	400	500	650	790	800	1000	1100	1400	1500	2000
Minimum Pressure (in W.C.)	6.00	6.00	7.00	7.00	7.00	7.00	7.50	7.50	9.00	7.00	8.00	8.00	9.00
	4.50	5.50	6.00	5.00	5.50	7.00	6.50	6.50	6.50	5.00	5.00	5.00	6.00
Maximum Pressure (psig)	0.50	0.50	0.50	0.50	0.50	0.50	0.50	0.50	0.50	0.50	0.50	0.50	0.50
High Pressure (psig)	2.0–10.0	2.0–10.0	2.0–10.0	2.0–10.0	2.0–10.0	2.0–10.0	2.0–10.0	2.0–10.0	2.0–10.0	2.0–10.0	2.0–10.0	2.0–10.0	2.0–10.0

Electric Heat

208 Volts

Table 15: RPS and RFS 015D to 042D—208V Electric Heat Air Temperature Rise (°F)

Airflow (cfm)	Electric Heater Model Number					
	20	40	60	80	100	120
	Electric Heater Capacity (MBh)					
	51	102	154	204	255	306
6000	7.8	15.7	23.7	31.3	39.2	47.0
7000	6.7	13.4	20.3	26.9	33.6	40.3
8000	5.9	11.8	17.7	23.5	29.4	35.3
9000	5.2	10.4	15.8	20.9	26.1	31.3
10000	4.7	9.4	14.2	18.8	23.5	28.2
11000	4.3	8.5	12.9	17.1	21.4	25.6
12000	3.9	7.8	11.8	15.7	19.6	23.5
13000	3.6	7.2	10.9	14.5	18.1	21.7
14000	3.4	6.7	10.1	13.4	16.8	20.1
15000	3.1	6.3	9.5	12.5	15.7	18.8
16000	2.9	5.9	8.9	11.8	14.7	17.6

The maximum temperature rise allowed for electric heat is 60°F with leaving air temperature not to exceed 140°F.
The minimum airflow required for unit sizes 015D to 040D with electric heat is 6,000 cfm.

Table 16: RPS and RFS 045D to 079D—208V Electric Heat Air Temperature Rise (°F)

Airflow (cfm)	Electric Heater Model Number					
	40	60	80	100	120	160
	Electric Heater Capacity (MBh)					
	102	154	204	255	306	408
14000	6.7	10.1	13.4	16.8	20.1	26.9
15000	6.3	9.5	12.5	15.7	18.8	25.1
16000	5.9	8.9	11.8	14.7	17.6	23.5
17000	5.5	8.3	11.1	13.8	16.6	22.1
18000	5.2	7.9	10.4	13.1	15.7	20.9
19000	4.9	7.5	9.9	12.4	14.8	19.8
20000	4.7	7.1	9.4	11.8	14.1	18.8
21000	4.5	6.8	9.0	11.2	13.4	17.9
22000	4.3	6.5	8.5	10.7	12.8	17.1
23000	4.1	6.2	8.2	10.2	12.3	16.3
24000	3.9	5.9	7.8	9.8	11.8	15.7
25000	3.8	5.7	7.5	9.4	11.3	15.0
26000	3.6	5.5	7.2	9.0	10.8	14.5
27000	3.5	5.3	7.0	8.7	10.4	13.9
28000	3.4	5.1	6.7	8.4	10.1	13.4
29000	3.2	4.9	6.5	8.1	9.7	13.0
30000	3.1	4.7	6.3	7.8	9.4	12.5

The maximum temperature rise allowed for electric heat is 60°F with leaving air temperature not to exceed 140°F.
The minimum airflow required for unit sizes 045D to 079D with electric heat is 14,000 cfm.

Table 17: RPS and RFS 080D to 140D—208V Electric Heat Air Temperature Rise (°F)

Airflow (cfm)	Electric Heater Model Number		
	80	100	120
	Electric Heater Capacity (MBh)		
	204	255	306
22000	8.5	10.7	12.8
24000	7.8	9.8	11.8
26000	7.2	9.0	10.8
28000	6.7	8.4	10.1
30000	6.3	7.8	9.4
32000	5.9	7.3	8.8
34000	5.5	6.9	8.3
36000	5.2	6.5	7.8
38000	4.9	6.2	7.4
40000	4.7	5.9	7.1
42000	4.5	5.6	6.7
44000	4.3	5.3	6.4
46000	4.1	5.1	6.1
48000	3.9	4.9	5.9
50000	3.8	4.7	5.6

The maximum temperature rise allowed for electric heat is 60°F with leaving air temperature not to exceed 140°F.
 The minimum airflow required for units 080D to 140D with electric heat is 22,000 cfm.

230, 460, and 575 Volts

Table 18: RPS and RFS 015D to 042D—230V, 460V, 575V Electric Heat Air Temperature Rise (°F)

Airflow (cfm)	Electric Heater Model Number											
	20	40	60	80	100	120	140	160	180*	200*	220*	240*
	Electric Heater Capacity (MBh)											
	63	125	188	249	312	374	439	499	564	624	689	748
6000	9.7	19.2	28.9	38.2	47.9	57.5	n/a	n/a	n/a	n/a	n/a	n/a
7000	8.3	16.5	24.8	32.8	41.1	49.2	57.8	n/a	n/a	n/a	n/a	n/a
8000	7.3	14.4	21.7	28.7	35.9	43.1	50.6	57.5	n/a	n/a	n/a	n/a
9000	6.5	12.8	19.3	25.5	32.0	38.3	45.0	51.1	57.8	n/a	n/a	n/a
10000	5.8	11.5	17.3	22.9	28.8	34.5	40.5	46.0	52.0	57.5	n/a	n/a
11000	5.3	10.5	15.8	20.9	26.1	31.3	36.8	41.8	47.3	52.3	57.7	n/a
12000	4.8	9.6	14.4	19.1	24.0	28.7	33.7	38.3	43.3	47.9	52.9	57.5
13000	4.5	8.9	13.3	17.7	22.1	26.5	31.1	35.4	40.0	44.2	48.8	53.0
14000	4.1	8.2	12.4	16.4	20.5	24.6	28.9	32.9	37.1	41.1	45.4	49.2
15000	3.9	7.7	11.6	15.3	19.2	23.0	27.0	30.7	34.7	38.3	42.3	46.0
16000	3.6	7.2	10.8	14.3	18.0	21.5	25.3	28.7	32.5	35.9	39.7	43.1

The maximum temperature rise allowed for electric heat is 60°F with leaving air temperature not to exceed 140°F.
 The minimum airflow required for units 015D to 042D with electric heat is 6,000 cfm.
 140 through 240 electric heaters available at 460 or 575 volts only.

Table 19: RPS and RFS 045D to 079D—230V, 460V, 575V Electric Heat Air Temperature Rise (°F)

Airflow (cfm)	Electric Heater Model Number								
	40	60	80	100	120	160	180	200	240
	Electric Heater Capacity (MBh)								
	125	188	249	312	374	499	564	624	748
14000	8.2	12.4	16.4	20.5	24.6	32.9	37.1	41.1	49.2
15000	7.7	11.6	15.3	19.2	23.0	30.7	34.7	38.3	46.0
16000	7.2	10.8	14.3	18.0	21.5	28.7	32.5	35.9	43.1
17000	6.8	10.2	13.5	16.9	20.3	27.1	30.6	33.8	40.6
18000	6.4	9.6	12.7	16.0	19.2	25.6	28.9	32.0	38.3
19000	6.1	9.1	12.1	15.1	18.1	24.2	27.4	30.3	36.3
20000	5.8	8.7	11.5	14.4	17.2	23.0	26.0	28.8	34.5
21000	5.5	8.3	10.9	13.7	16.4	21.9	24.8	27.4	32.8
22000	5.2	7.9	10.4	13.1	15.7	20.9	23.6	26.1	31.3
23000	5.0	7.5	10.0	12.5	15.0	20.0	22.6	25.0	30.0
24000	4.8	7.2	9.6	12.0	14.4	19.2	21.7	24.0	28.7
25000	4.6	6.9	9.2	11.5	13.8	18.4	20.8	23.0	27.6
26000	4.4	6.7	8.8	11.1	13.3	17.7	20.0	22.1	26.5
27000	4.3	6.4	8.5	10.7	12.8	17.0	19.3	21.3	25.5
28000	4.1	6.2	8.2	10.3	12.3	16.4	18.6	20.5	24.6
29000	4.0	6.0	7.9	9.9	11.9	15.9	17.9	19.8	23.8
30000	3.8	5.8	7.6	9.6	11.5	15.3	17.3	19.2	23.0

The maximum temperature rise allowed for electric heat is 60°F with leaving air temperature not to exceed 140°F.
 The minimum airflow required for units 045D to 079D with electric heat is 14,000 cfm.
 180 through 240 electric heaters available at 460 or 575 volts only.

Table 20: RPS and RFS 080D to 140D—230V, 460V, 575V Electric Heat Air Temperature Rise (°F)

Airflow (cfm)	Electric Heater Model Number							
	80	100	120	160	200	240	280	320
	Electric Heater Capacity (MBh)							
	249	312	374	499	624	748	873	998
22000	10.4	13.1	15.7	20.9	26.1	31.3	36.6	41.8
24000	9.6	12.0	14.4	19.2	24.0	28.7	33.5	38.3
26000	8.8	11.1	13.3	17.7	22.1	26.5	30.9	35.4
28000	8.2	10.3	12.3	16.4	20.5	24.6	28.7	32.9
30000	7.6	9.6	11.5	15.3	19.2	23.0	26.8	30.7
32000	7.2	9.0	10.8	14.4	18.0	21.5	25.1	28.7
34000	6.7	8.5	10.1	13.5	16.9	20.3	23.7	27.1
36000	6.4	8.0	9.6	12.8	16.0	19.2	22.4	25.6
38000	6.0	7.6	9.1	12.1	15.1	18.1	21.2	24.2
40000	5.7	7.2	8.6	11.5	14.4	17.2	20.1	23.0
42000	5.5	6.8	8.2	11.0	13.7	16.4	19.2	21.9
44000	5.2	6.5	7.8	10.5	13.1	15.7	18.3	20.9
46000	5.0	6.3	7.5	10.0	12.5	15.0	17.5	20.0
48000	4.8	6.0	7.2	9.6	12.0	14.4	16.8	19.2
50000	4.6	5.8	6.9	9.2	11.5	13.8	16.1	18.4

The maximum temperature rise allowed for electric heat is 60°F with leaving air temperature not to exceed 140°F.
 The minimum airflow required for units 080D to 140D with electric heat is 22,000 cfm.
 160 through 320 electric heaters available at 460 or 575 volts only.

Hot Water Heat

RPS, RFS, RDT 015D to 042D

Figure 39: Hot Water Coil, Low Capacity, 015D to 042D

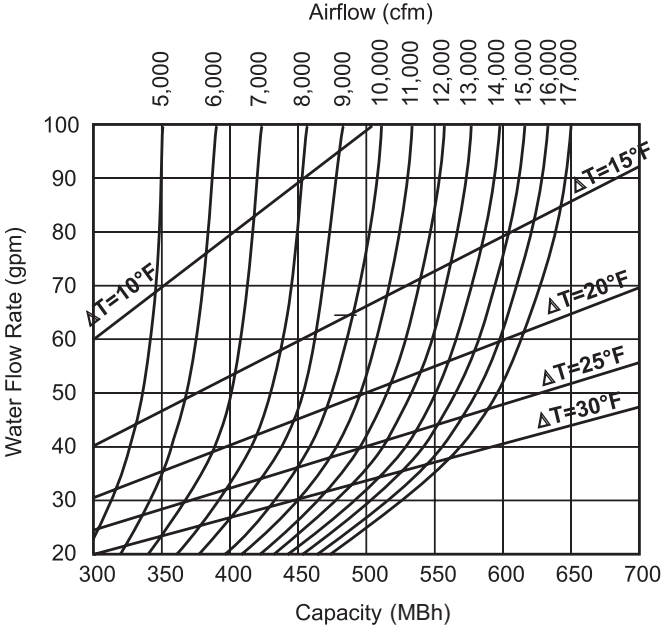

Figure 40: Hot Water Coil, High Capacity, 015D to 042D

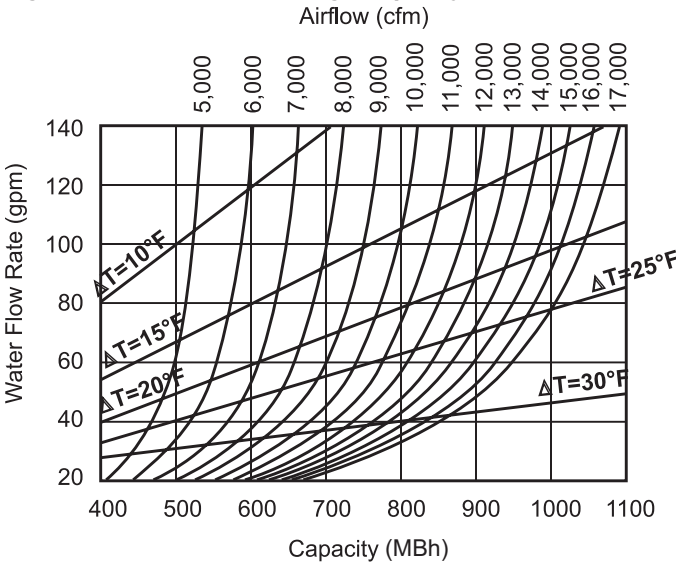

Figure 41: Hot Water Coil Pressure Drop (Headers Included), 015D to 042D

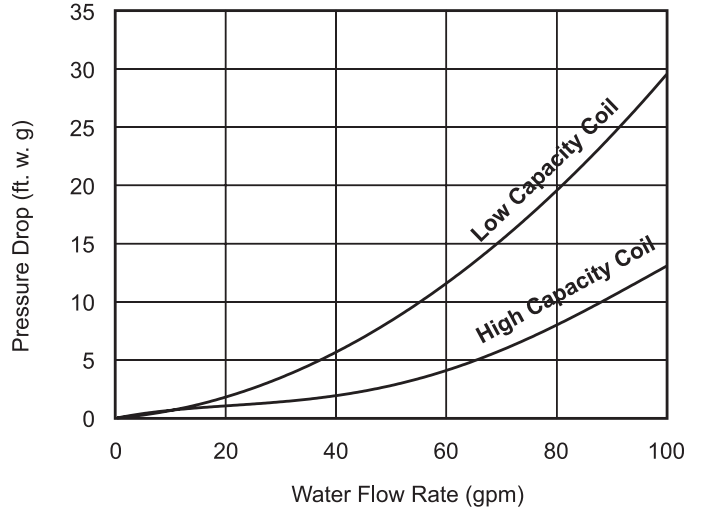
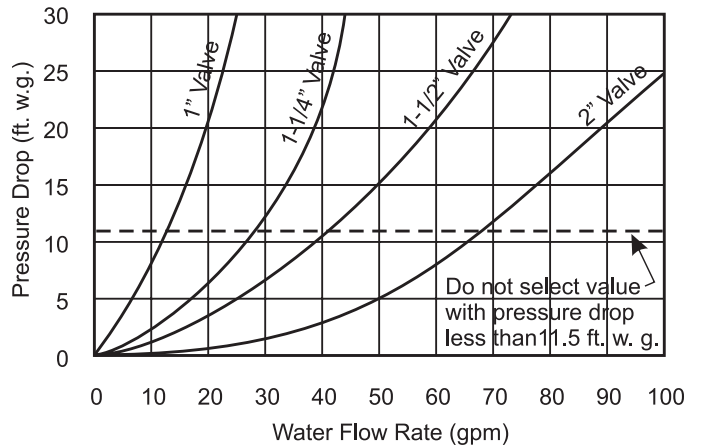

Figure 42: Hot Water Valve and Piping Pressure Drop, 015D to 042D



RPS, RFS, RDT 045D to 140D

Figure 43: Hot Water Coil, Low Capacity, 045D to 079D

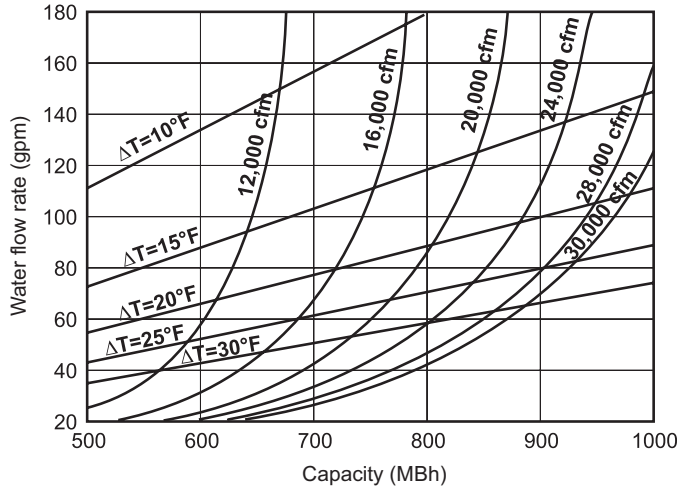

Figure 45: Hot Water Coil, Low Capacity, 080D to 140D

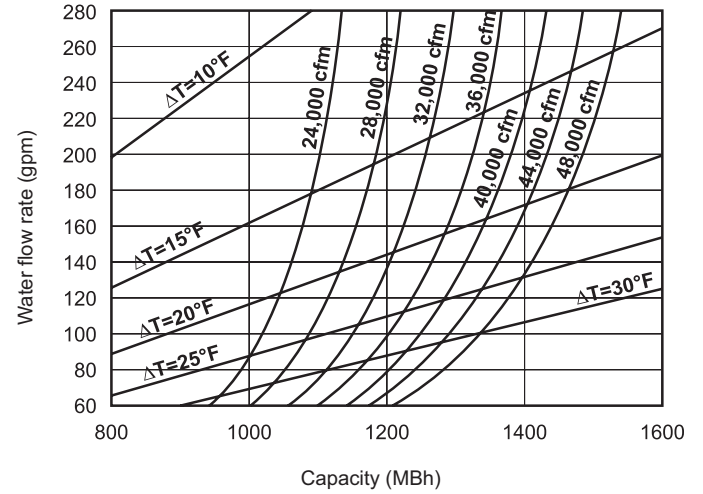

Figure 44: Hot Water Coil, High Capacity, 045D to 079D

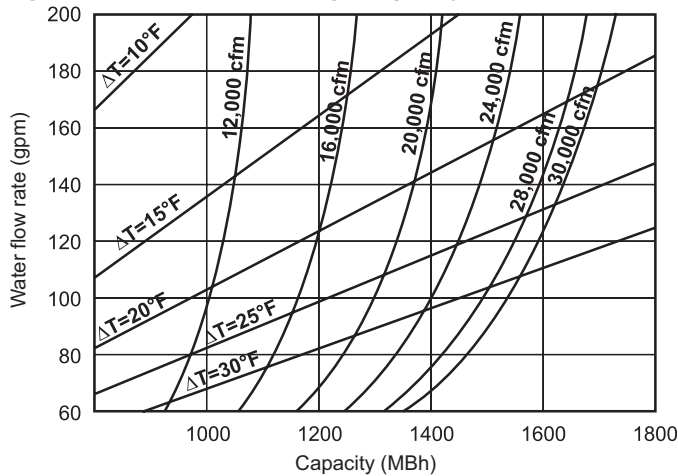

Figure 46: Hot Water Coil, High Capacity, 080D to 140D

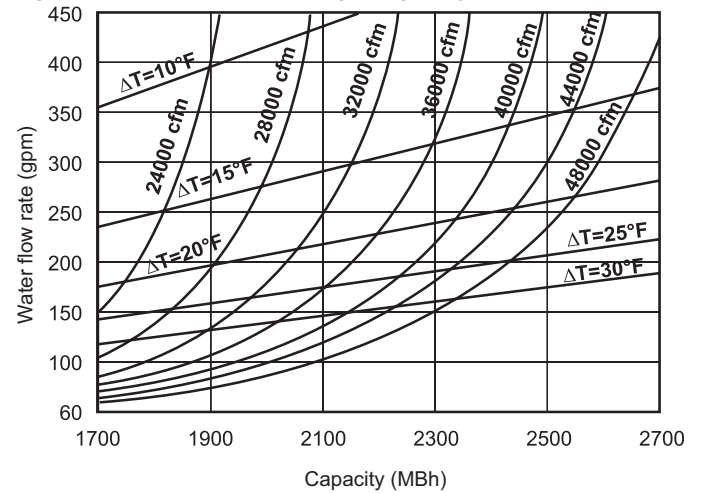

Figure 47: Hot Water Coil Pressure Drop (headers included, does not include valve and valve piping), 045D to 140D

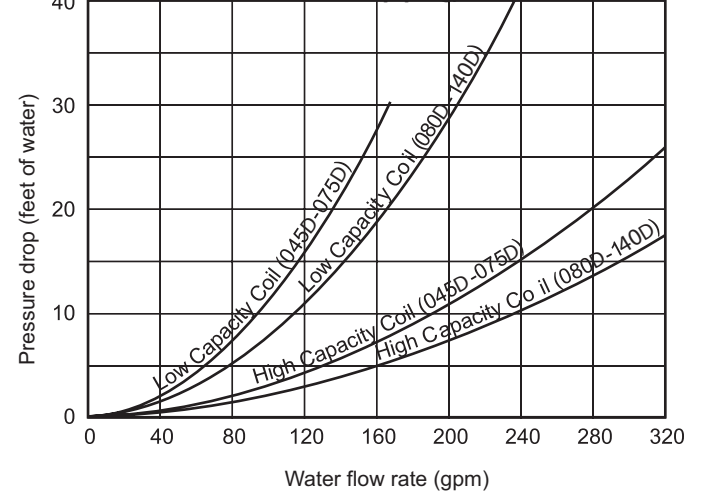

Figure 48: Hot Water Valve Pressure Drop (does not include piping and coil), RPS and RFS 045D to 140D

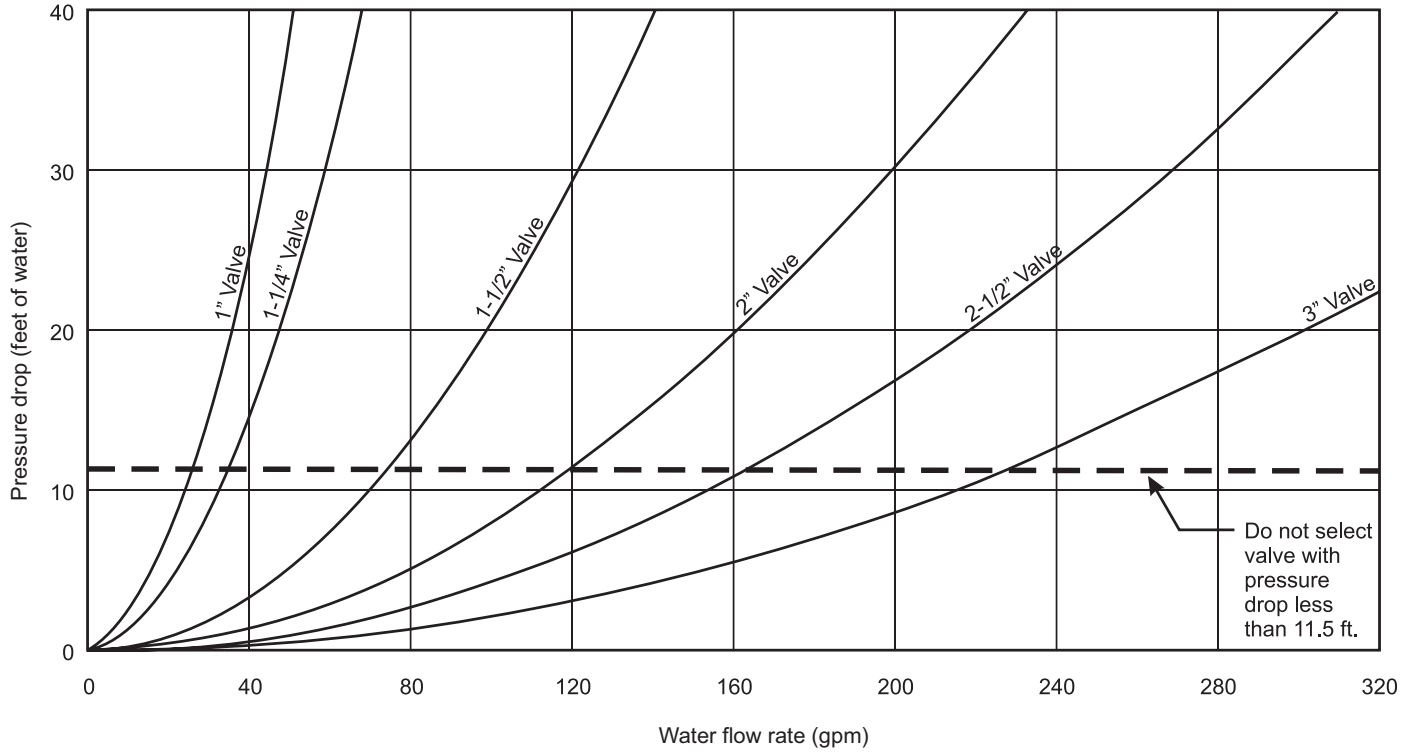
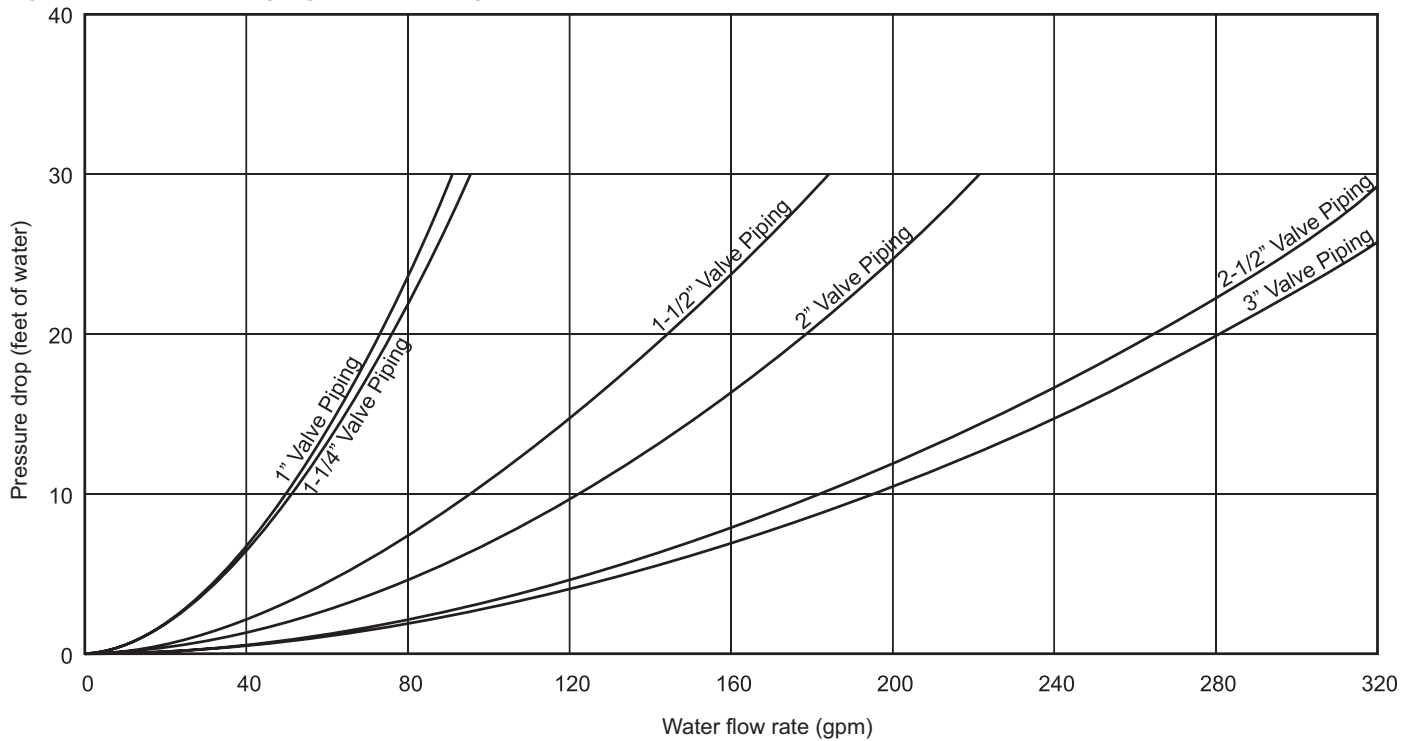

Figure 49: Hot Water Piping Pressure Drop (does not include valve and coil), RPS and RFS 045D to 140D



Steam Heat

RPS, RFS, RDT 015D to 042D

Figure 50: Steam Coil, Low Capacity, 015D to 042D

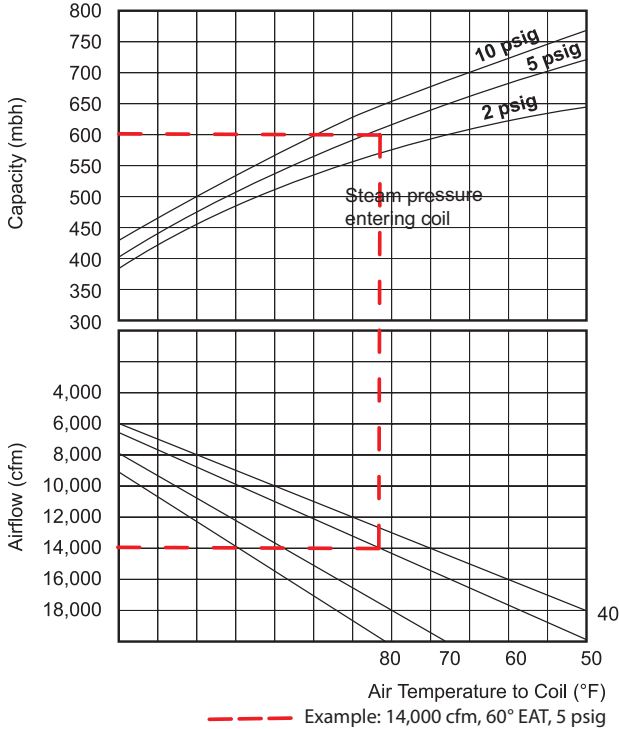

Figure 51: Steam Coil, High Capacity, 015D to 042D

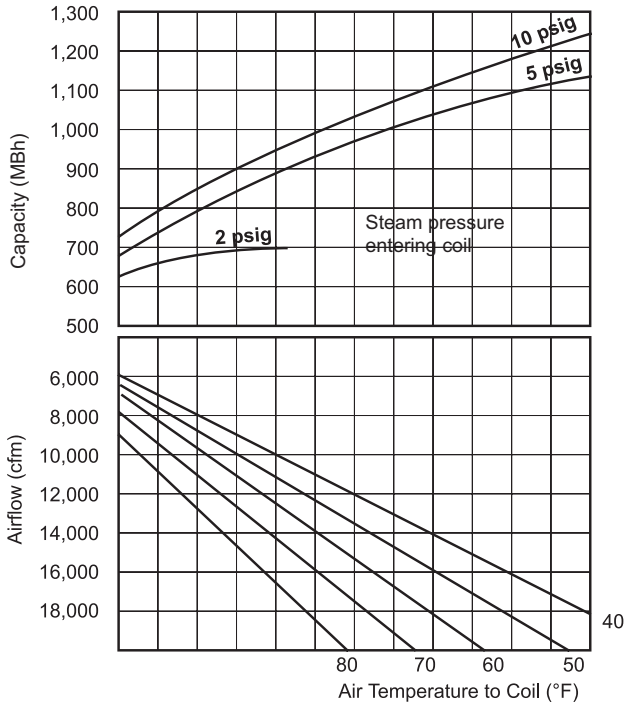

Figure 52: Steam Coil, Low Capacity, 045D to 079D

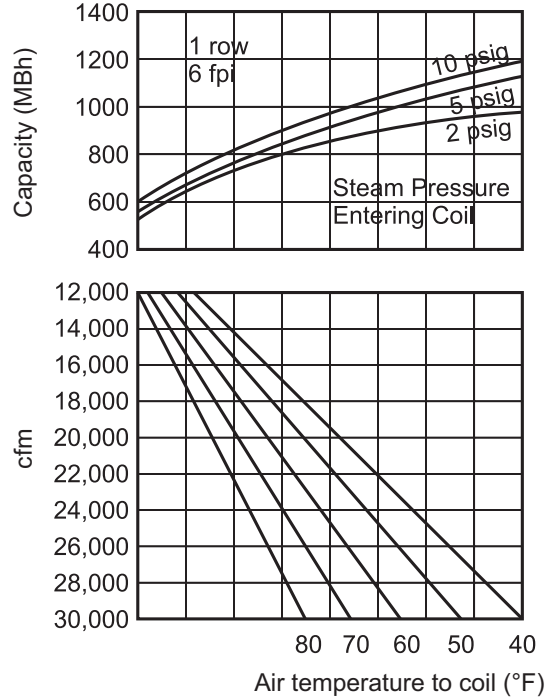

Figure 53: Steam Coil, High Capacity, 045D to 079D

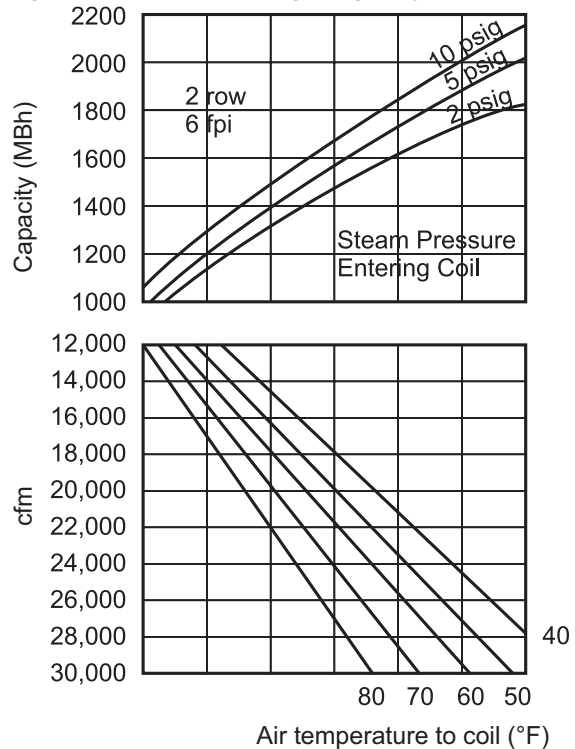

Figure 54: Steam Coil, Medium Capacity, 045D to 079D

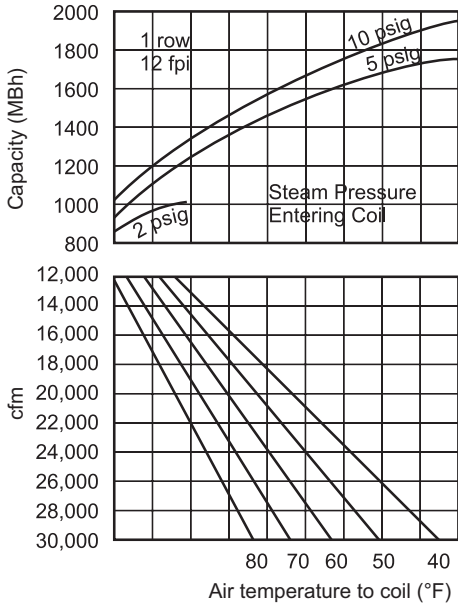

Figure 56: Steam Coil, Low Capacity, 080D to 140D

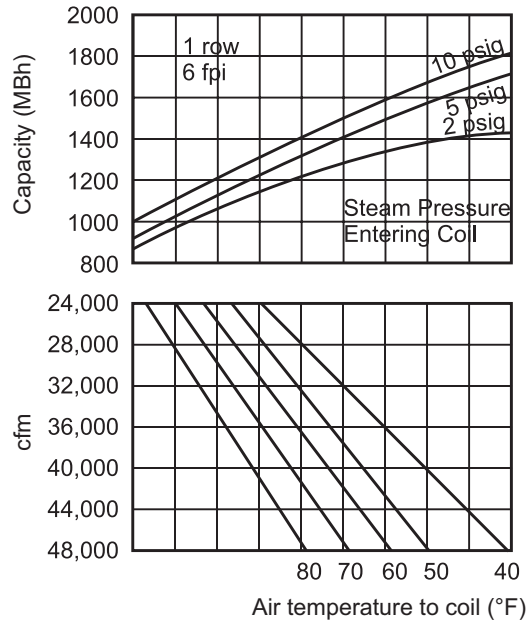

Figure 55: Steam Coil, Medium Capacity, 080D to 140D

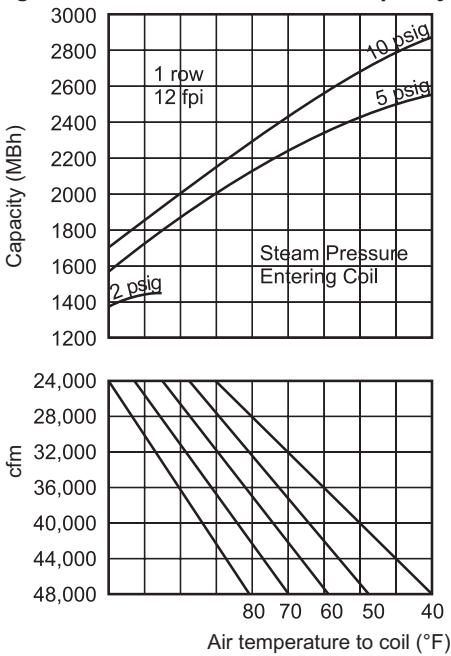

Figure 57: Steam Coil, High Capacity, 080D to 140D

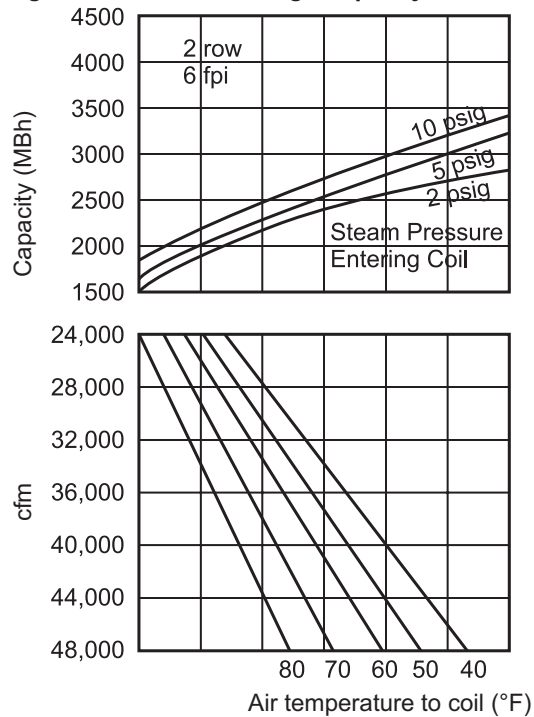

Table 21: Steam Valve Selection Chart

Valve size (inches)	Condensate rate, lb./hr.			
	Steam supply pressure			
	5 psig	10 psig	15 psig	25 psig
1	196–260	301–380	391–480	571–650
1 1/4	261–380	381–560	481–700	651–940
1 1/2	381–600	561–870	701–1090	940–1470
2	601–950	871–1390	1091–1750	1471–2350
2 1/2	951–1330	1391–1940	1751–2450	2351–3290
3	1331–2020	1941–2950	2451–3716	—

Table 22: Saturated Steam Properties

Pressure (psig)	Temperature (°F)	Latent heat (btu/lb.)
2	218.5	966.1
5	227.1	960.6
10	239.4	952.6
15	249.7	945.7
25	266.8	934.0

Table 23: RPS and RFS 015D to 042D (in. w.g.)

Unit Airflow (cfm)	Filter				Evaporator Coils ^a					
	Angular Rack	Flat Rack			018D –020D			025D –042D		
		30% Pleated	Pre-filters	65% Cartridge	95% Cartridge	5-row 8 fpi	5-row 10 fpi	5-row 12 fpi	5-row 8 fpi	5-row 10 fpi
4,000	0.02	0.06	0.08	0.12	0.16	0.19	0.23	—	—	—
5,000	0.03	0.08	0.12	0.17	0.22	0.27	0.33	—	—	—
6,000	0.04	0.10	0.16	0.23	0.30	0.35	0.42	0.17	0.20	0.24
7,000	0.05	0.13	0.20	0.29	0.37	0.44	0.53	0.21	0.25	0.30
8,000	0.07	0.16	0.25	0.35	0.45	0.54	0.64	0.26	0.31	0.37
9,000	0.08	0.19	0.31	0.42	0.54	0.64	0.75	0.31	0.36	0.43
10,000	0.09	0.22	0.36	0.49	0.63	0.74	0.87	0.36	0.42	0.50
11,000	0.10	0.25	0.43	0.56	0.72	0.84	0.99	0.41	0.49	0.58
12,000	0.12	0.28	0.49	0.64	0.81	0.95	—	0.46	0.55	0.65
13,000	0.13	0.32	0.56	0.72	—	—	—	0.54	0.64	0.75
14,000	0.14	0.35	0.63	0.81	—	—	—	0.60	0.71	0.84
15,000	0.16	0.39	0.71	0.89	—	—	—	0.67	0.79	0.92
16,000	0.18	0.43	0.79	0.98	—	—	—	0.73	0.86	1.01
17,000	0.19	0.47	0.87	1.07	—	—	—	0.80	0.94	—
18,000	0.21	0.50	0.95	1.17	—	—	—	—	—	—

a. Pressure drop is for wet coil

Table 24: RPS and RFS 015D to 042D (in. w.g.)

Unit Airflow (cfm)	Coils				Economizer Return Damper	100% O.A. Hood with Dampers
	Hot Water		Steam			
	Low Capacity	High Capacity	Low Capacity	High Capacity		
4,000	0.03	0.05	0.02	0.04	0.01	0.01
5,000	0.04	0.08	0.03	0.06	0.02	0.01
6,000	0.06	0.11	0.04	0.07	0.03	0.01
7,000	0.08	0.14	0.05	0.09	0.04	0.02
8,000	0.09	0.18	0.06	0.11	0.05	0.02
9,000	0.12	0.22	0.07	0.13	0.07	0.03
10,000	0.14	0.27	0.08	0.14	0.08	0.03
11,000	0.17	0.31	0.09	0.16	0.10	0.04
12,000	0.20	0.36	0.10	0.18	0.12	0.05
13,000	0.22	0.41	0.11	0.20	0.15	0.06
14,000	0.26	0.46	0.12	0.23	0.17	0.06
15,000	0.29	0.53	0.13	0.25	0.20	0.07
16,000	0.32	0.60	0.15	0.27	0.23	0.08
17,000	0.36	0.66	0.16	0.30	0.26	0.09
18,000	0.40	0.74	0.17	0.32	0.29	0.10

Table 25: RFS and RDT 045D to 079D

Component		Airflow (cfm)								
		14,000	16,000	18,000	20,000	22,000	24,000	26,000	28,000	30,000
Outdoor/ Return Air Options ^{a, b}	0–30% outside air hood w/damper	0.06	0.08	0.10	0.12	0.15	0.18	0.21	0.24	0.28
	100% outside air hood w/damper	0.01	0.02	0.02	0.03	0.03	0.04	0.05	0.05	0.06
	0–100% economizer, w/o RAF	0.08	0.10	0.13	0.16	0.19	0.23	0.27	0.31	0.36
	0–100% economizer, w/RAF	0.21	0.25	0.29	0.33	0.38	0.43	0.48	0.54	0.59
Filter Options	30% pleated	0.08	0.10	0.12	0.14	0.16	0.18	0.20	0.25	0.27
	Prefilter, standard flow	0.17	0.20	0.24	0.28	0.32	0.37	0.41	—	—
	Prefilter, medium flow	0.13	0.15	0.18	0.21	0.25	0.28	0.32	0.35	0.39
	65% cartridge, standard flow	0.27	0.34	0.41	0.49	0.57	0.66	0.76	—	—
	65% cartridge, medium flow	0.20	0.25	0.31	0.36	0.43	0.49	0.56	0.63	0.71
	95% cartridge, standard flow	0.38	0.46	0.55	0.64	0.74	0.84	0.95	—	—
Plenum Options	Return, isolation damper	0.02	0.03	0.03	0.03	0.03	0.03	0.03	0.03	0.03
	Discharge, isolation damper	0.03	0.03	0.03	0.03	0.03	0.03	0.03	0.03	0.03
Cooling Options ^{c, d, e}	DX, low airflow, 5-row, 10 fpi	0.41	0.50	0.59	0.69	0.79	0.89	—	—	—
	DX, low airflow, 5-row, 12 fpi	0.49	0.59	0.70	0.81	0.93	—	—	—	—
	DX, high airflow, 5-row, 10 fpi	—	0.38	0.45	0.52	0.60	0.68	0.79	0.88	0.98
	DX, high airflow, 5-row, 12 fpi	—	0.45	0.54	0.62	0.71	0.80	0.93	1.04	—
	Cooling diffuser	0.04	0.05	0.06	0.08	0.10	0.11	0.13	0.15	0.18
Heating Options ^b	Hot water, 1-row	0.12	0.15	0.19	0.22	0.26	0.30	0.35	0.39	0.44
	Hot water, 2-row	0.24	0.30	0.37	0.44	0.52	0.61	0.69	0.78	0.88
	Steam, 1-row, 6 fpi	0.10	0.12	0.15	0.18	0.21	0.24	0.27	0.31	0.35
	Steam, 1-row, 12 fpi	0.16	0.20	0.24	0.28	0.33	0.38	0.43	0.48	0.54
	Steam, 2-row, 6 fpi	0.19	0.24	0.30	0.35	0.41	0.48	0.55	0.62	0.70
	Electric heat	0.07	0.10	0.12	0.15	0.18	0.22	0.25	0.29	0.34
	Gas heat	See Table 28: Furnace Pressure Drop (in. w.c.), RPS and RFS 015D to 140D on page 59.								

a. Pressure drop through hood and damper is based on 30% of listed airflow.

b. Pressure drop through the economizer assumes that the majority of air is passing through the return air dampers. If large quantities of outside air are required, pressure drops increase, causing airflow to decrease.

c. Pressure drop of cooling coils not shown can be found in the Daikin Applied Selection Program output.

d. DX coil pressure drops are based on wet coils.

e. A cooling diffuser is provided on units with blow-through cooling only.

Table 26: RPS, RFS, RDT 080D to 140D

Component		Airflow (cfm)								
		18,000	22,000	26,000	30,000	34,000	38,000	42,000	46,000	50,000
Outdoor/ Return Air Options ^{a, b}	0-30% outside air hood w/damper	0.05	0.08	0.11	0.14	0.18	0.23	0.28	0.34	0.40
	100% outside air hood w/damper	0.01	0.02	0.03	0.03	0.04	0.06	0.07	0.08	0.09
	Economizer, w/o RAF	0.06	0.10	0.15	0.20	0.26	0.32	0.39	0.46	0.54
	Economizer, w/RAF	0.16	0.22	0.29	0.36	0.44	0.52	0.61	0.70	0.80
Filter Options	2" throwaway	0.15	0.07	0.09	0.11	0.13	—	—	—	—
	30% pleated	0.06	0.08	0.11	0.13	0.15	0.18	0.21	0.24	0.27
	Prefilter, standard flow	0.15	0.20	0.24	0.31	0.37	—	—	—	—
	Prefilter, medium flow	0.12	0.16	0.21	0.25	0.31	0.36	—	—	—
	Prefilter, high flow	0.09	0.12	0.15	0.18	0.22	0.26	0.30	0.34	0.39
	65% cartridge, standard flow	0.24	0.33	0.43	0.55	0.68	—	—	—	—
	65% cartridge, medium flow	0.19	0.27	0.35	0.44	0.54	0.65	—	—	—
	65% cartridge, high flow	0.13	0.18	0.24	0.31	0.38	0.45	0.53	0.62	0.71
	95% cartridge, standard flow	0.33	0.45	0.57	0.71	0.85	—	—	—	—
	95% cartridge, medium flow	0.27	0.37	0.47	0.58	0.70	0.83	—	—	—
Plenum Options	Return, isolation damper	0.02	0.02	0.03	0.03	0.03	0.03	0.03	0.03	0.03
	Discharge, isolation damper	0.03	0.03	0.03	0.03	0.03	0.03	0.03	0.03	0.03
Cooling Options ^{c, d, e}	Cooling diffuser	0.04	0.05	0.07	0.10	0.13	0.16	0.19	0.23	0.28
	Cooling coils	See Table 27: Cooling Coil Air Pressure Drops, RPS, RFS, RDT 080D to 140D on page 59.								
Heating Options ^d	Hot water, 1-row	0.10	0.14	0.19	0.24	0.30	0.36	0.43	0.50	0.58
	Hot water, 2-row	0.20	0.28	0.38	0.48	0.60	0.72	0.86	1.00	1.16
	Steam, 1-row, 6 fpi	0.10	0.12	0.15	0.19	0.24	0.29	0.34	0.40	0.46
	Steam, 1-row, 12 fpi	0.14	0.19	0.25	0.31	0.37	0.45	0.52	0.60	0.69
	Steam, 2-row, 6 fpi	0.16	0.23	0.30	0.39	0.48	0.58	0.68	0.80	0.92
	Electric heat	0.07	0.10	0.14	0.19	0.24	0.30	0.37	0.45	0.53
	Gas heat	See Table 28: Furnace Pressure Drop (in. w.c.), RPS and RFS 015D to 140D on page 59.								

a. Pressure drop through hood and damper is based on 30% of listed airflow.

b. Pressure drop through the economizer assumes that the majority of air is passing through the return air dampers. If large quantities of outside air are required, pressure drops increase, causing airflow to decrease.

c. Pressure drop of cooling coils not shown can be found in the Daikin Applied Selection Program output.

d. DX coil pressure drops are based on wet coils.

e. A cooling diffuser is provided on units with blow-through cooling only

Table 27: Cooling Coil Air Pressure Drops, RPS, RFS, RDT 080D to 140D

Unit Size	Cooling Coil	Airflow (cfm)											
		28000	30000	32000	34000	36000	38000	40000	42000	44000	46000	48000	50000
080D to 090D	DX, low airflow, 5-row, 10 fpi	0.72	0.78	0.87	0.95	—	—	—	—	—	—	—	—
	DX, low airflow, 5-row, 12 fpi	0.85	0.92	1.02	—	—	—	—	—	—	—	—	—
	DX, high airflow, 5-row, 10 fpi	0.60	0.65	0.72	0.79	0.86	0.93	—	—	—	—	—	—
	DX, high airflow, 5-row, 12 fpi	0.71	0.77	0.85	0.93	1.01	—	—	—	—	—	—	—
100D to 140D	DX, low airflow, 5-row, 10 fpi	0.60	0.67	0.74	0.81	0.88	0.95	—	—	—	—	—	—
	DX, low airflow, 5-row, 12 fpi	0.72	0.80	0.87	0.95	1.04	—	—	—	—	—	—	—
	DX, high airflow, 5-row, 10 fpi	0.43	0.48	0.53	0.58	0.63	0.68	0.73	0.78	0.84	0.89	0.95	1.01
	DX, high airflow, 5-row, 12 fpi	0.52	0.57	0.62	0.68	0.74	0.80	0.86	0.92	0.98	1.05	—	—

DX oil pressure drops are based on wet coils.
 Pressure drop of cooling coils not shown can be found in the Daikin Applied selection program output.

Table 28: Furnace Pressure Drop (in. w.c.), RPS and RFS 015D to 140D

Airflow (cfm)	Column Number, See Table 12 on page 47									
	1	2	3	4	5	6	7	8	9	10
4000	0.06	0.05	—	—	—	—	—	—	—	—
6000	0.13	0.1	—	—	—	—	—	—	—	—
8000	0.24	0.17	0.14	0.08	0.07	—	—	—	—	—
10000	0.37	0.27	0.22	0.12	0.11	0.09	0.08	—	—	—
12000	0.53	0.39	0.32	0.17	0.16	0.13	0.12	0.09	0.08	—
14000	0.72	0.54	0.44	0.24	0.21	0.18	0.16	0.12	0.1	0.1
16000	0.94	0.7	0.57	0.31	0.28	0.24	0.2	0.15	0.13	0.12
18000	1.19	0.89	0.72	0.39	0.35	0.3	0.26	0.19	0.17	0.16
20000	—	1.09	0.89	0.48	0.43	0.37	0.32	0.24	0.21	0.2
22000	—	—	1.08	0.58	0.52	0.44	0.39	0.29	0.25	0.24
24000	—	—	—	0.69	0.62	0.53	0.46	0.34	0.3	0.28
26000	—	—	—	0.81	0.73	0.62	0.54	0.4	0.35	0.33
28000	—	—	—	0.94	0.85	0.72	0.63	0.47	0.41	0.38
30000	—	—	—	1.08	0.97	0.83	0.72	0.54	0.47	0.44
32000	—	—	—	1.23	1.11	0.94	0.82	0.61	0.53	0.5
34000	—	—	—	—	1.25	1.06	0.92	0.69	0.6	0.56
36000	—	—	—	—	—	1.19	1.04	0.77	0.68	0.63
38000	—	—	—	—	—	—	1.15	0.86	0.75	0.7
40000	—	—	—	—	—	—	—	0.95	0.84	0.78
42000	—	—	—	—	—	—	—	1.05	0.92	0.86
44000	—	—	—	—	—	—	—	1.15	1.01	0.94
46000	—	—	—	—	—	—	—	—	1.11	1.03
48000	—	—	—	—	—	—	—	—	1.2	1.12
50000	—	—	—	—	—	—	—	—	—	1.22

Table 29: Gravity Relief Damper Air Pressure Drop, 0 to 100% Economizer

Exhaust cfm	5000	10000	15000	20000	25000	30000	35000	40000
Size 015D to 042D	—	.25	.54	—	—	—	—	—
Size 045D to 079D	—	—	.36	.61	1.00	—	—	—
Size 080D to 140D	—	—	—	.25	.35	.48	.66	.85

NOTE:
 If all exhaust must occur through the economizer gravity relief damper, and no return or exhaust fan is provided, then the building may be pressurized by the sum of the return duct pressure drop plus the gravity relief pressure.

Figure 58: RPS/RFS 015D to 031D (2) 15 in. × 6 in. Forward Curved Supply Fan

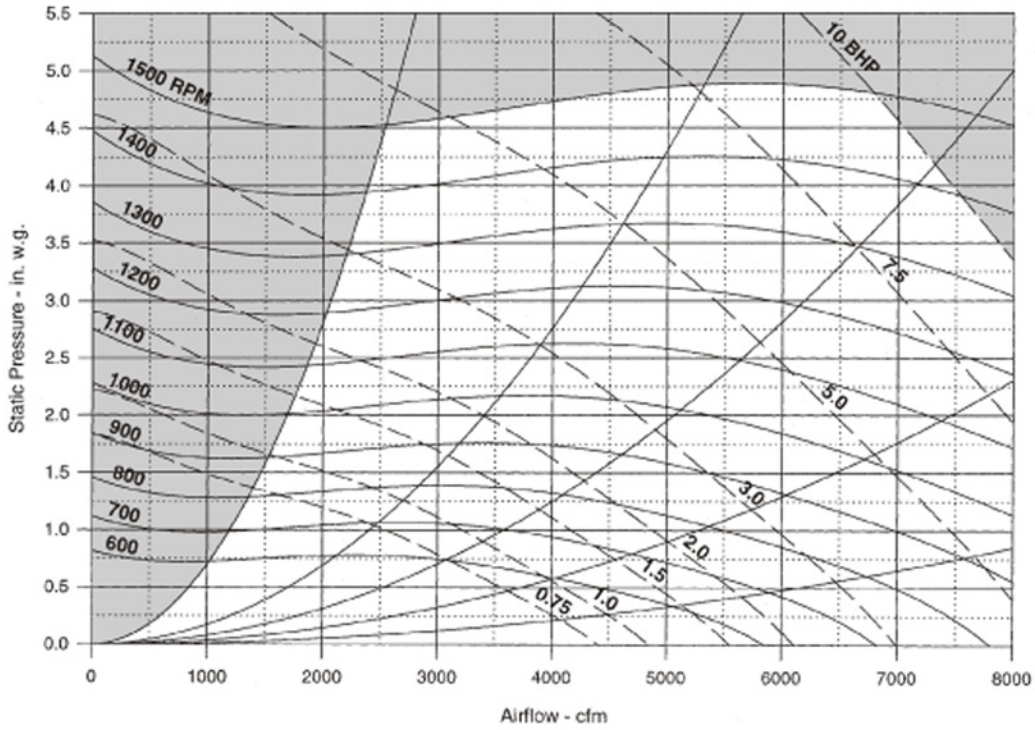

Do Not Select

NOTE: Maximum allowable static pressure at fan bulkhead is 5.0 in. (i.e., ESP plus blow-through component pressure drops cannot exceed 5.0 in).

Figure 59: RPS/RFS 015D to 031D (2) 15 in. × 15 in. Forward Curved Supply Fan

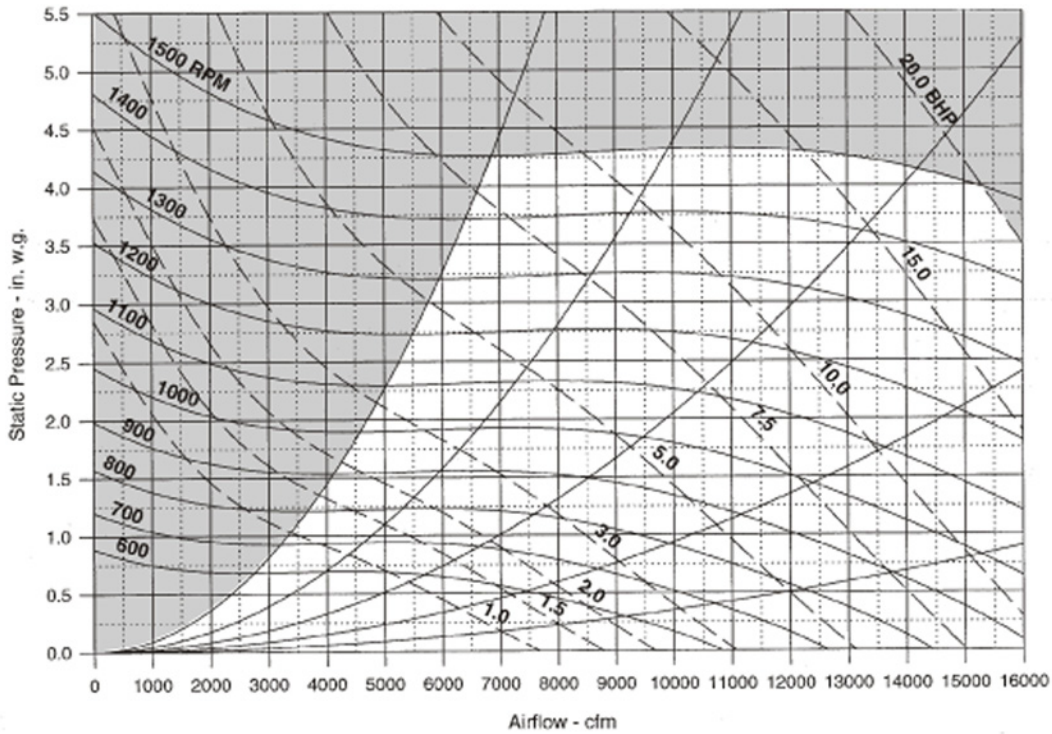

Do Not Select

NOTE: Maximum allowable static pressure at fan bulkhead is 5.0 in. (i.e., ESP plus blow-through component pressure drops cannot exceed 5.0 in).

Figure 60: RPS/RFS 015D to 031D 20 in. Airfoil Supply Fan

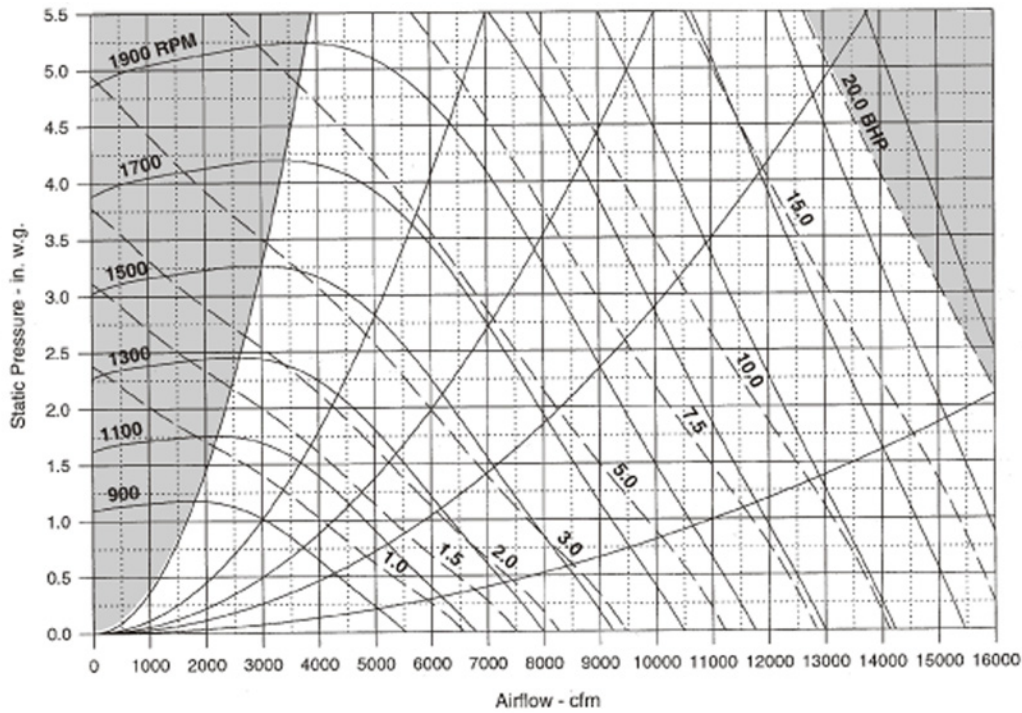

Do Not Select

NOTE: Maximum allowable static pressure at fan bulkhead is 5.0 in. (i.e., ESP plus blow-through component pressure drops cannot exceed 5.0 in).

Figure 61: RPS/RFS 035D to 042D 24 in. Forward Curve Supply Fan

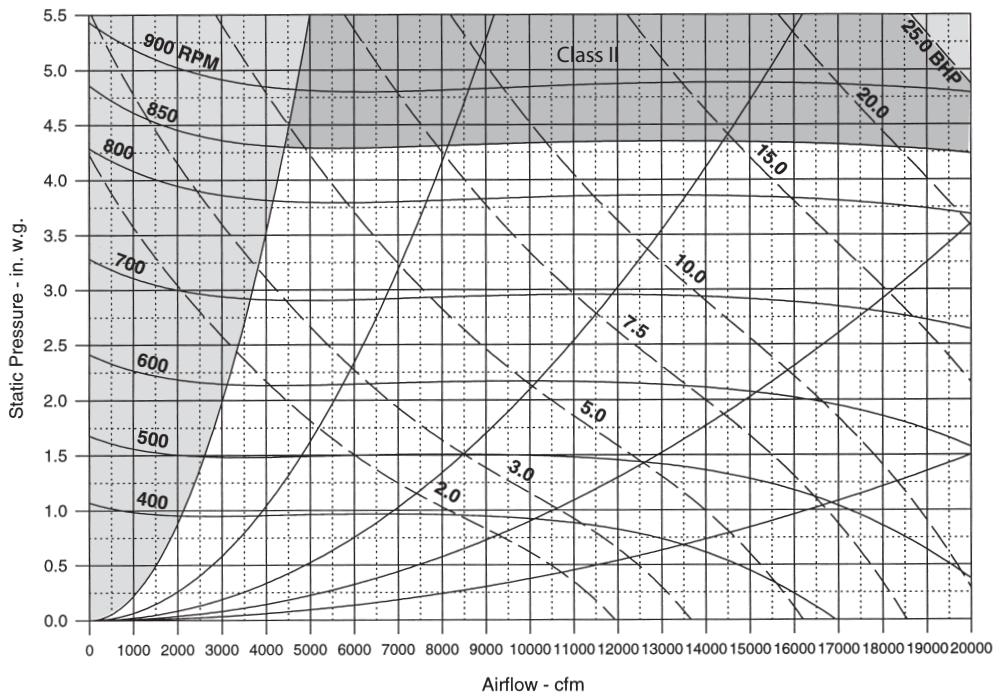

Do Not Select Class II Fan Required

NOTE: Maximum allowable static pressure at fan bulkhead is 5.0 in. (i.e., ESP plus blow-through component pressure drops cannot exceed 5.0 in).

Figure 62: RPS/RFS 035D to 042D 24 in. Airfoil Supply Fan

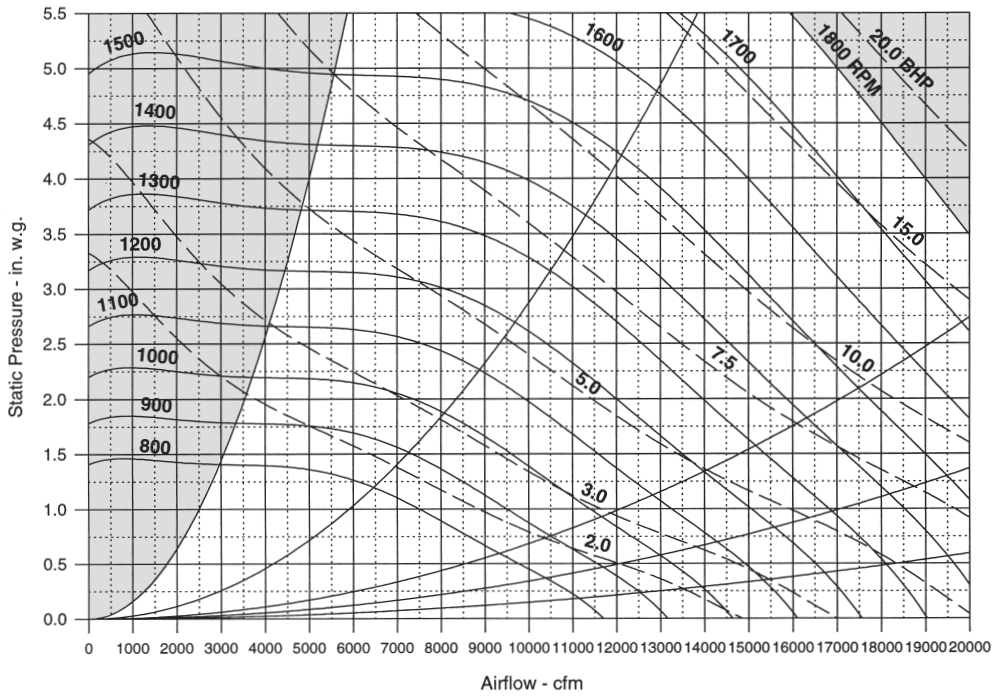

NOTE: Maximum allowable static pressure at fan bulkhead is 5.0 in. (i.e., ESP plus blow-through component pressure drops cannot exceed 5.0 in).

Figure 63: RPS/RFS 045D to 050D 27 in. Forward Curved Supply Fan

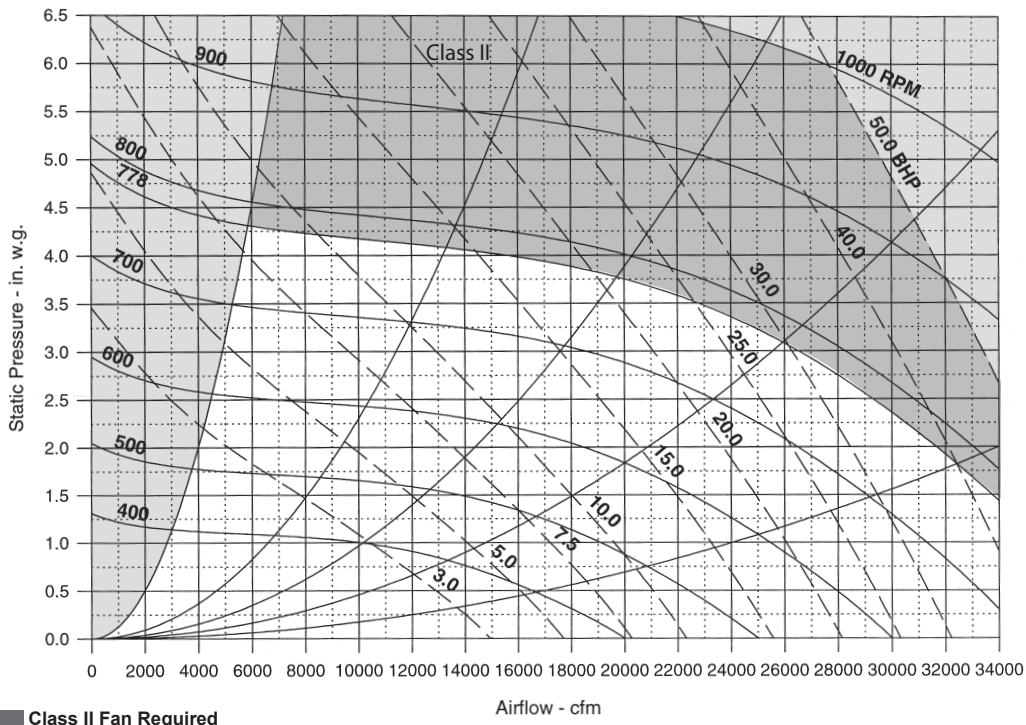

NOTE: Maximum allowable static pressure at fan bulkhead is 5.0 in. (i.e., ESP plus blow-through component pressure drops cannot exceed 5.0 in).

Figure 64: RPS/RFS 045D to 050D 27 in. Airfoil Supply Fan

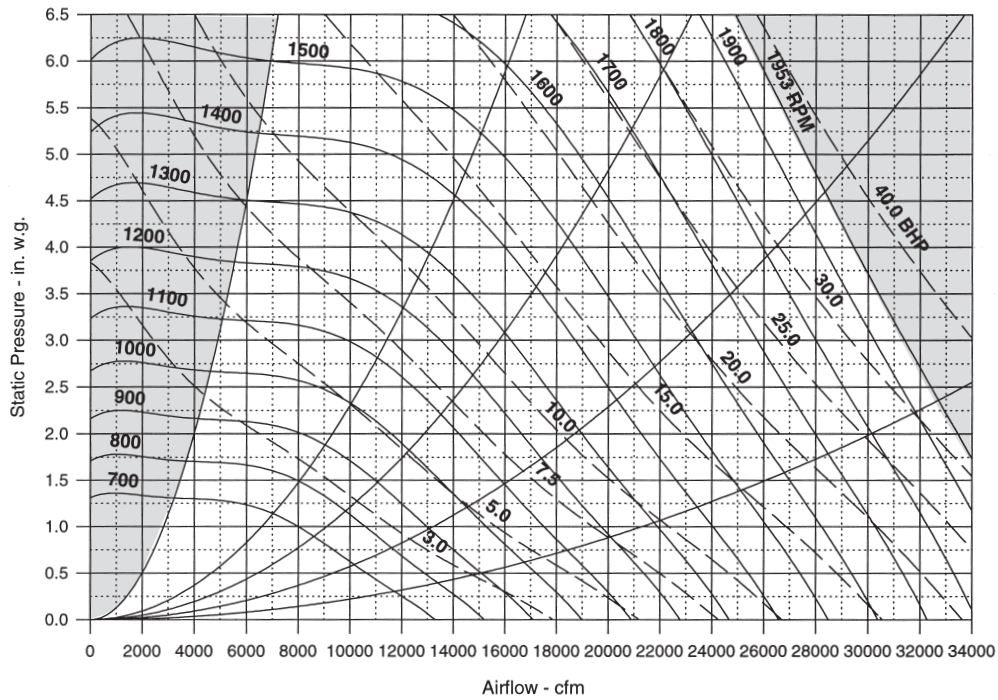

Do Not Select

NOTE: Maximum allowable static pressure at fan bulkhead is 5.0 in. (i.e., ESP plus blow-through component pressure drops cannot exceed 5.0 in).

Figure 65: RPS/RFS 045D to 079D 30 in. Airfoil Supply Fan

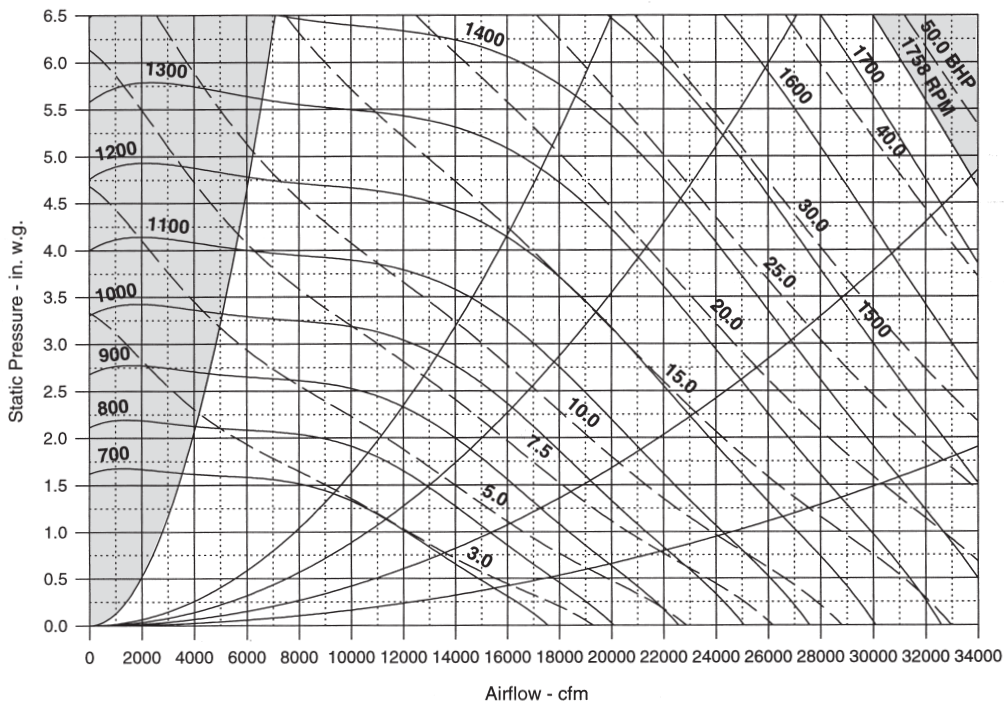

Do Not Select

NOTE: Maximum allowable static pressure at fan bulkhead is 5.0 in. (i.e., ESP plus blow-through component pressure drops cannot exceed 5.0 in).

Figure 66: RPS/RFS 060D to 079D 33 in. Airfoil Supply Fan

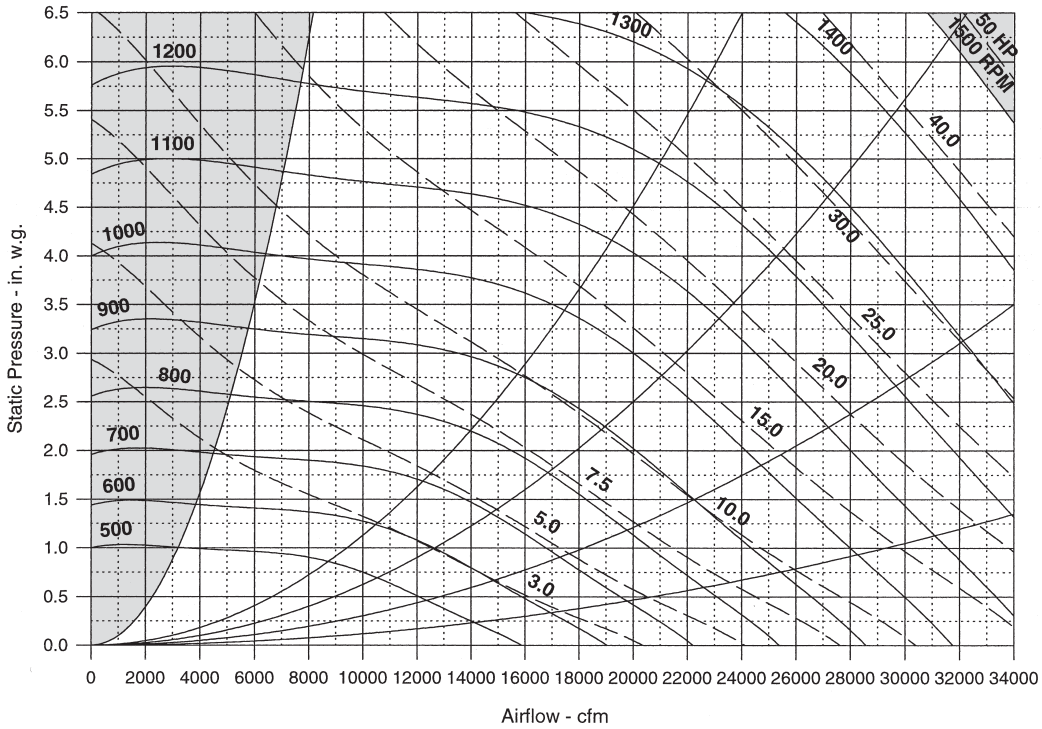

NOTE: Maximum allowable static pressure at fan bulkhead is 5.0 in. (i.e., ESP plus blow-through component pressure drops cannot exceed 5.0 in).

Figure 67: RDT 045D to 079D 40 in. SWSI Airfoil Supply Fan

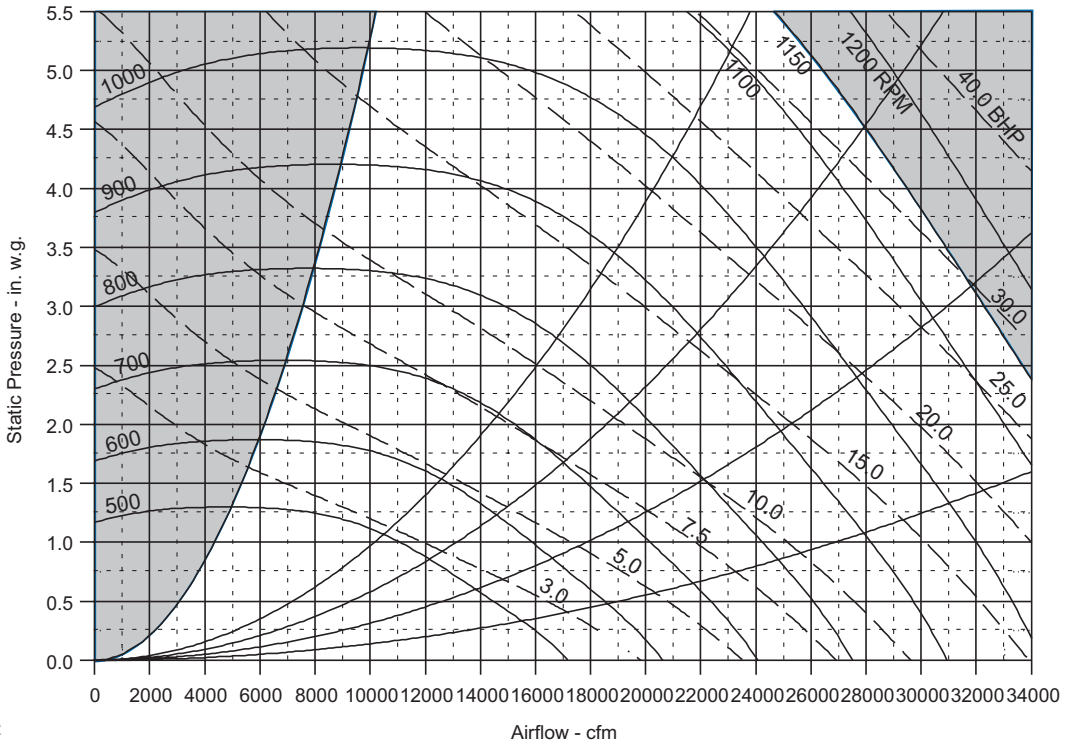

NOTE: Maximum allowable static pressure at fan bulkhead is 5.0 in. (i.e., ESP plus blow-through component pressure drops cannot exceed 5.0 in).

Figure 68: RDT 045D to 079D 44 in. SWSI Airfoil Supply Fan

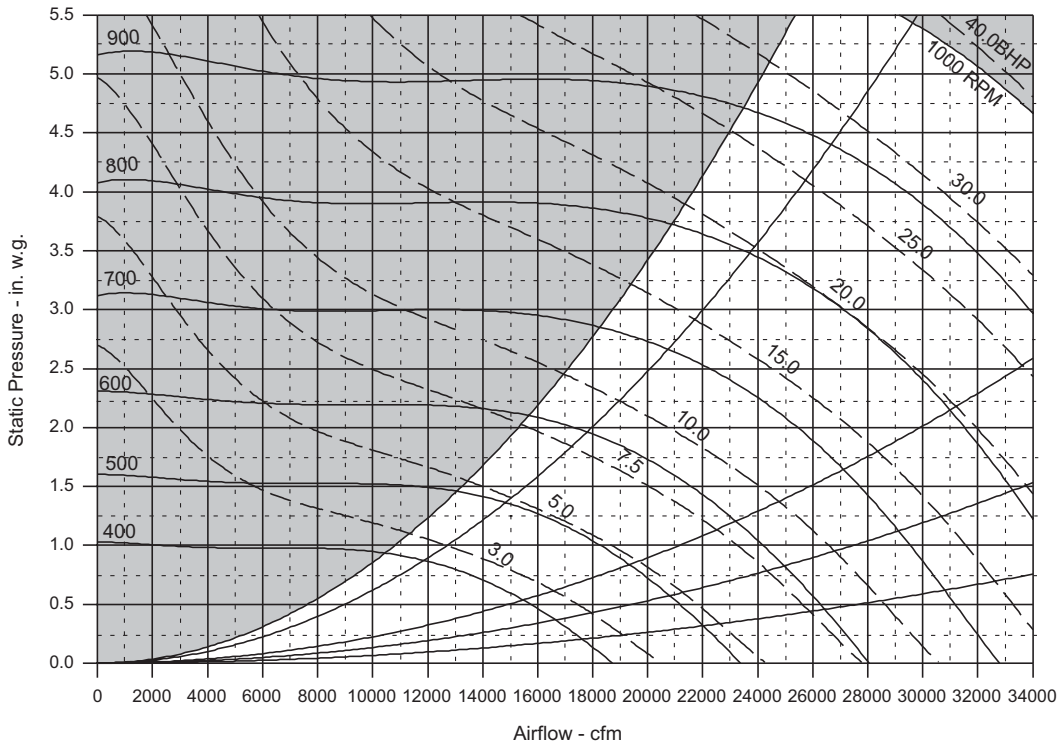

NOTE: Maximum allowable static pressure at fan bulkhead is 5.0 in. (i.e., ESP plus blow-through component pressure drops cannot exceed 5.0 in).

Figure 69: RDT 080D to 140D 44 in. SWSI Airfoil Supply Fan

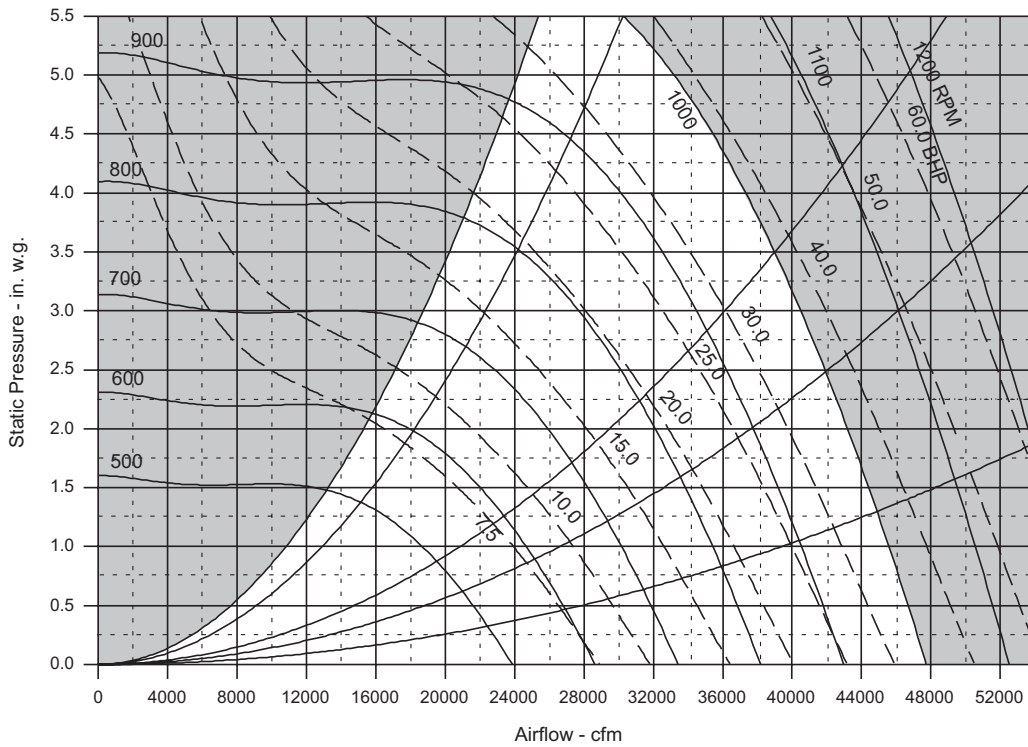

NOTE: Maximum allowable static pressure at fan bulkhead is 5.0 in. (i.e., ESP plus blow-through component pressure drops cannot exceed 5.0 in).

Figure 70: RDT 080D to 140D 49 in. SWSI Airfoil Supply Fan

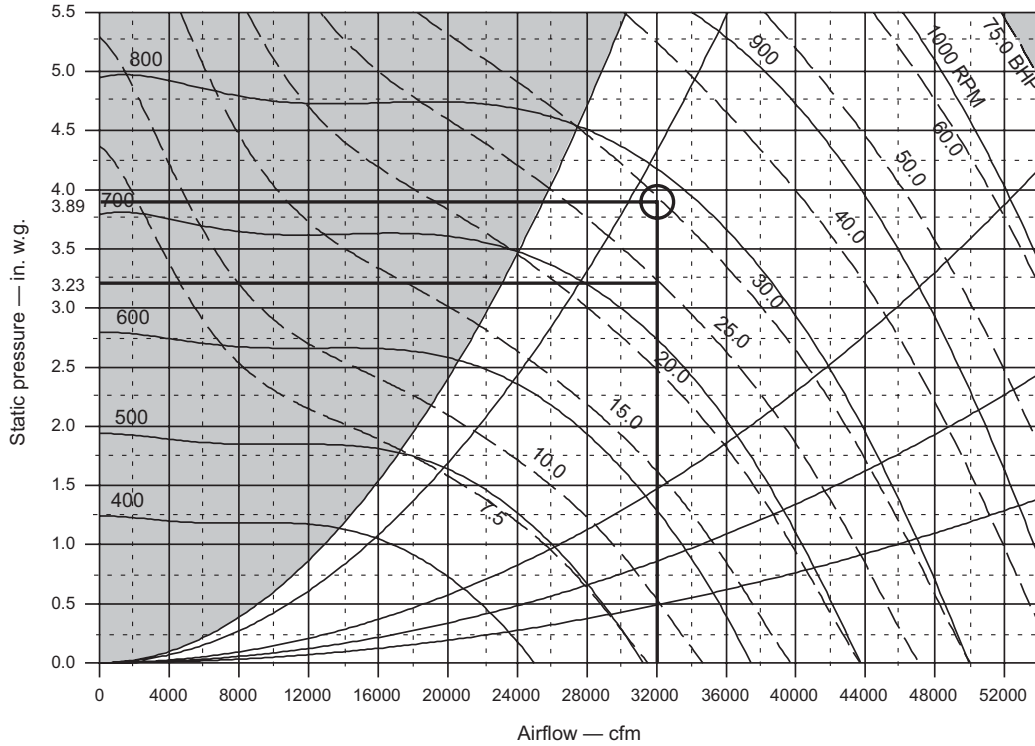

Do Not Select

NOTE: Maximum allowable static pressure at fan bulkhead is 5.0 in. (i.e., ESP plus blow-through component pressure drops cannot exceed 5.0 in).

Figure 71: RPS/RFS 080D to 105D 33 in. Airfoil Supply Fan

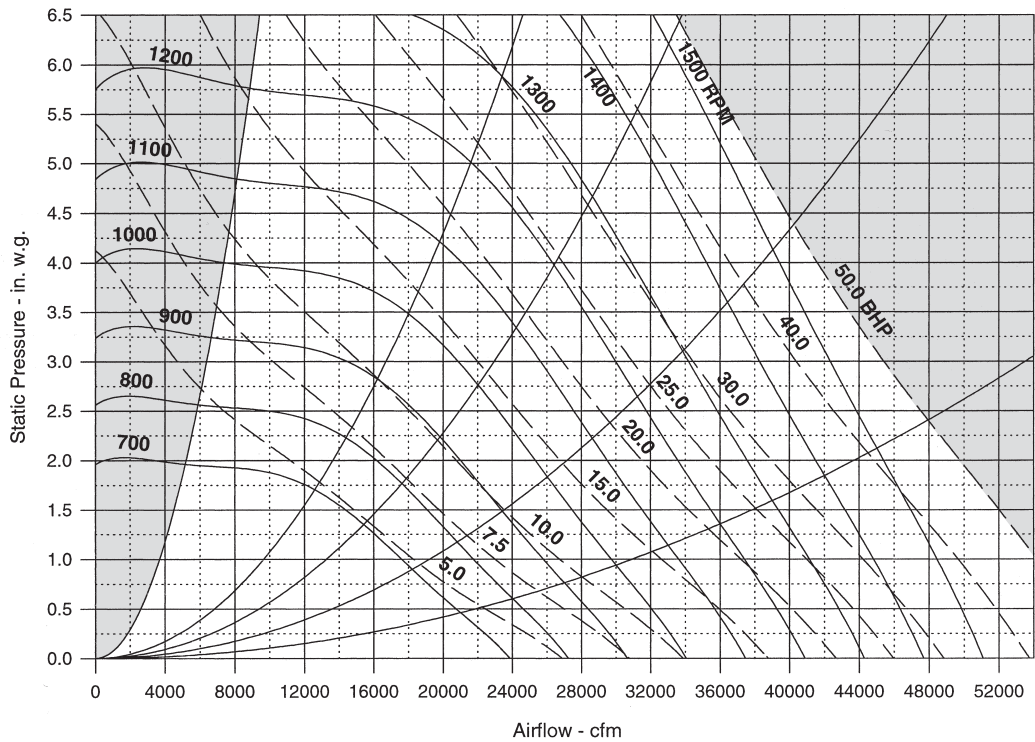

Do Not Select

NOTE: Maximum allowable static pressure at fan bulkhead is 5.0 in. (i.e., ESP plus blow-through component pressure drops cannot exceed 5.0 in).

Figure 72: RPS/RFS 080D to 140D 36 in. Airfoil Supply Fan

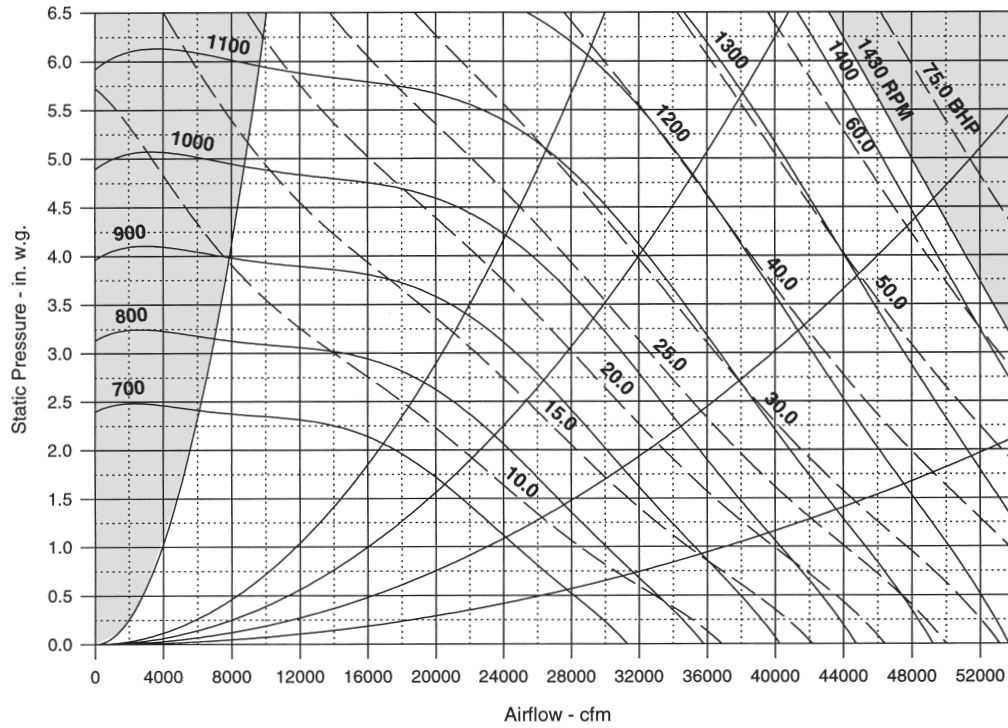

NOTE: Maximum allowable static pressure at fan bulkhead is 5.0 in. (i.e., ESP plus blow-through component pressure drops cannot exceed 5.0 in).

Figure 73: RPS/RFS 080D to 140D 40 in. Airfoil Supply Fan

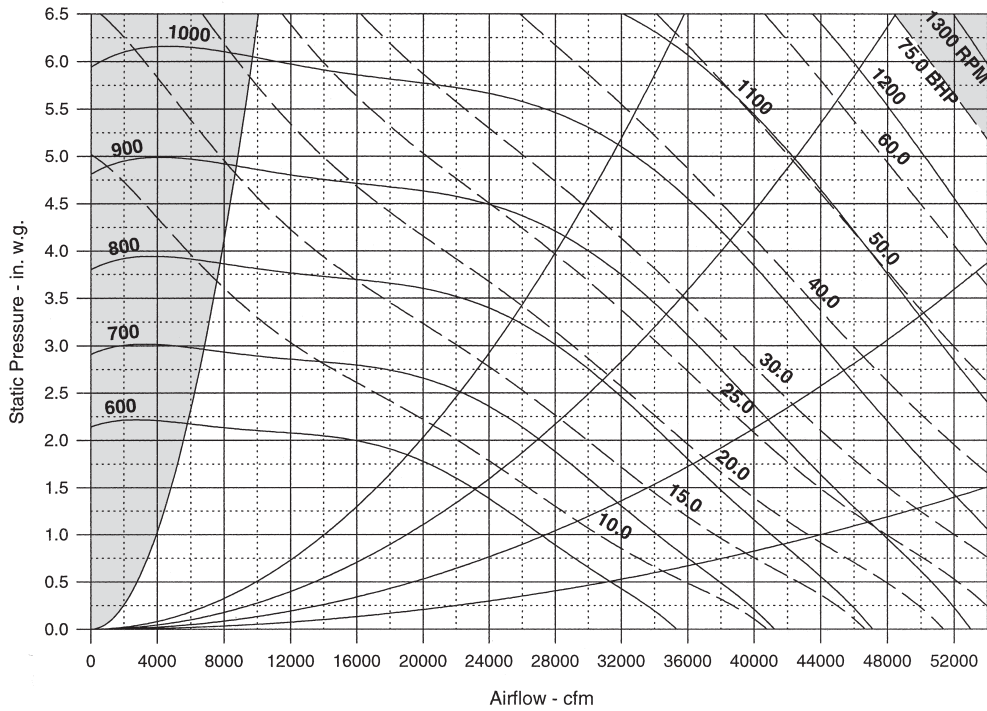

NOTE: Maximum allowable static pressure at fan bulkhead is 5.0 in. (i.e., ESP plus blow-through component pressure drops cannot exceed 5.0 in).

Figure 74: RPS/RFS/RDT 045D to 140D (1) 36 in. Propeller Exhaust Fan

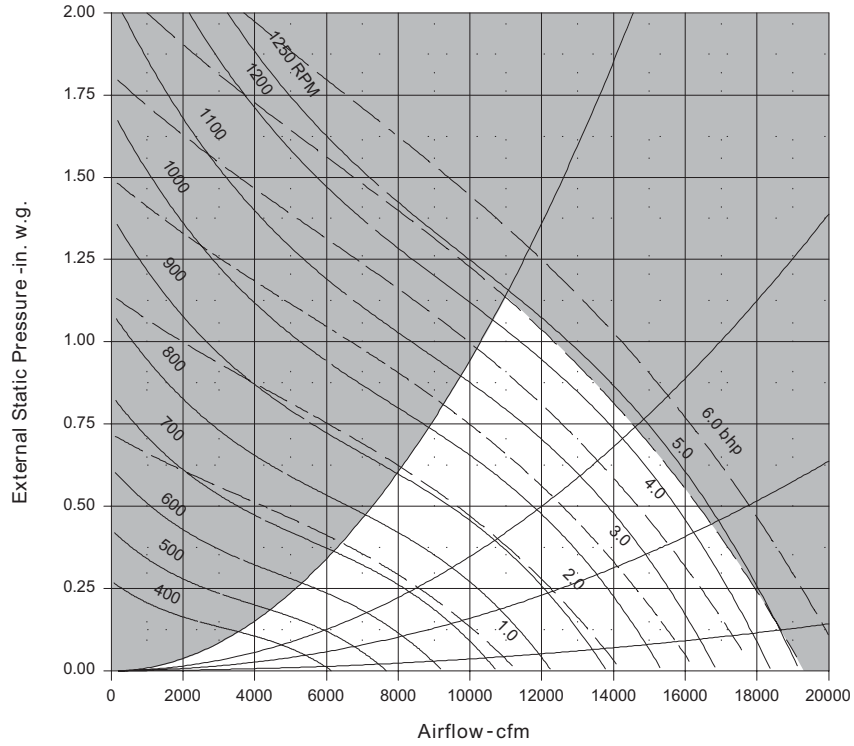

Figure 75: RPS/RFS/RDT 045D to 140D (2) 36 in. Propeller Exhaust Fan

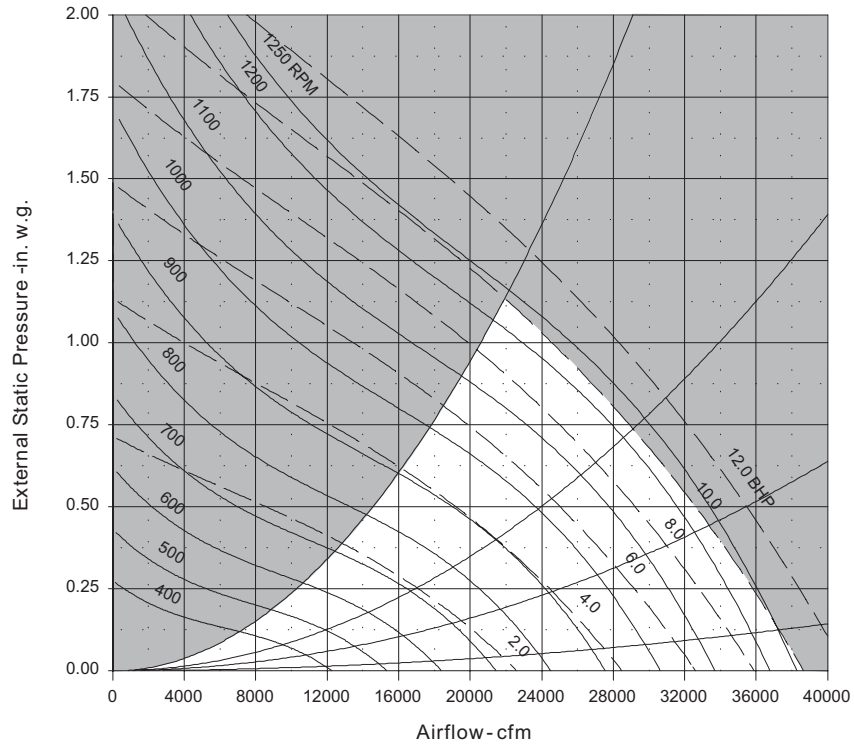

Figure 76: RPS/RFS/RDT 080D to 140D (3) 36 in. Propeller Exhaust Fan

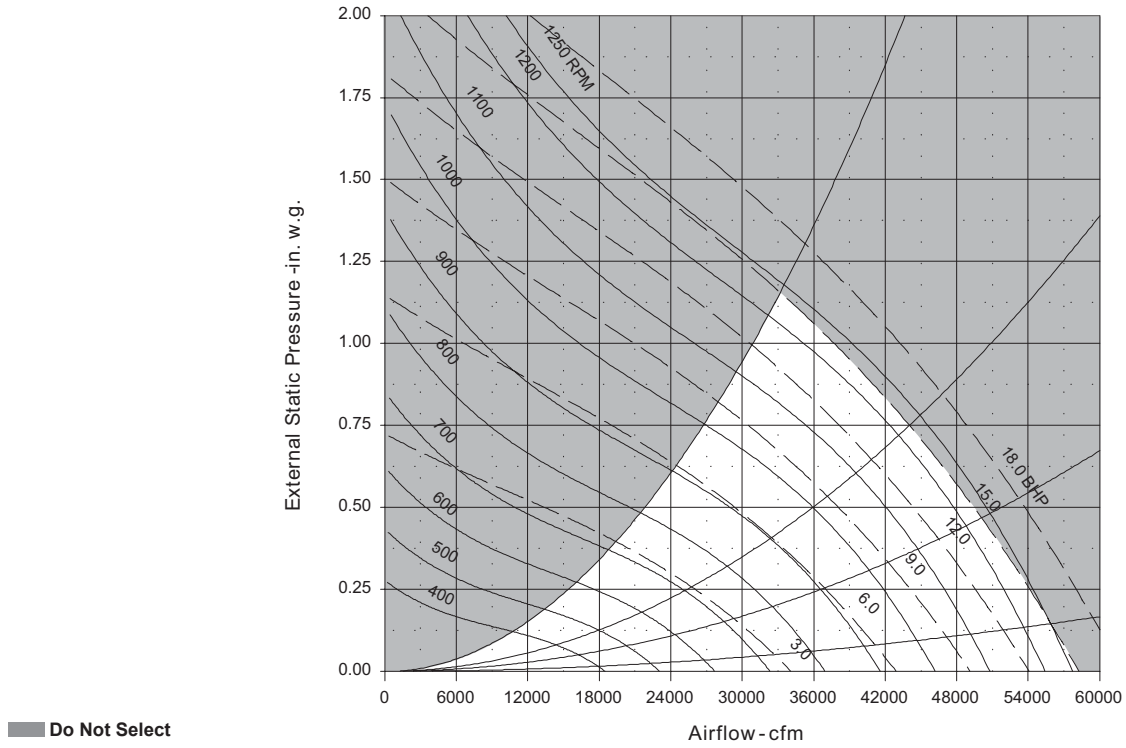
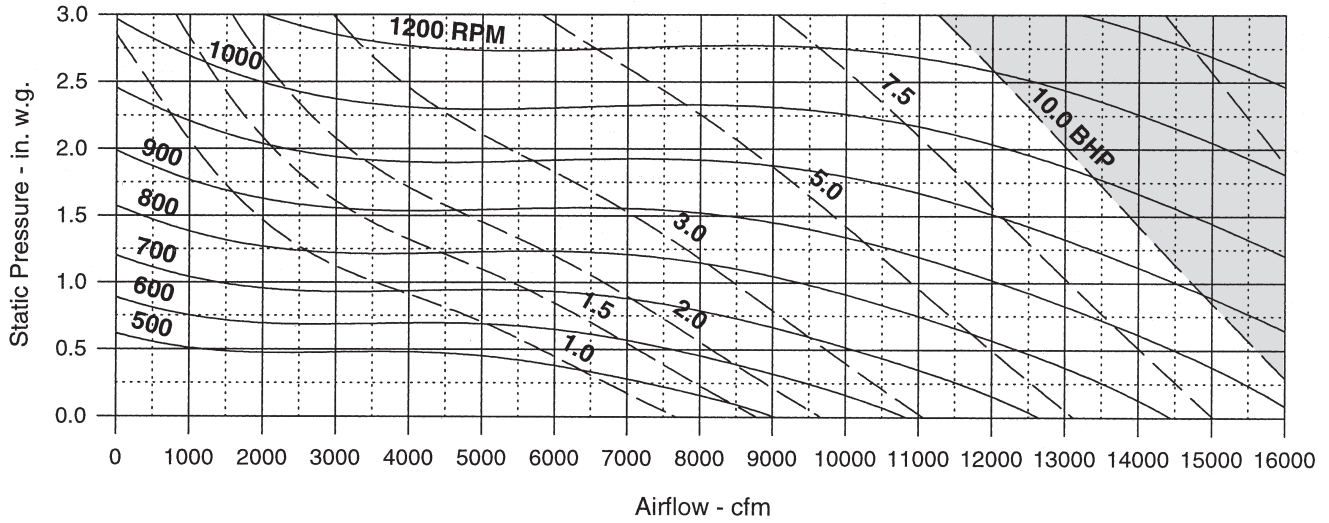
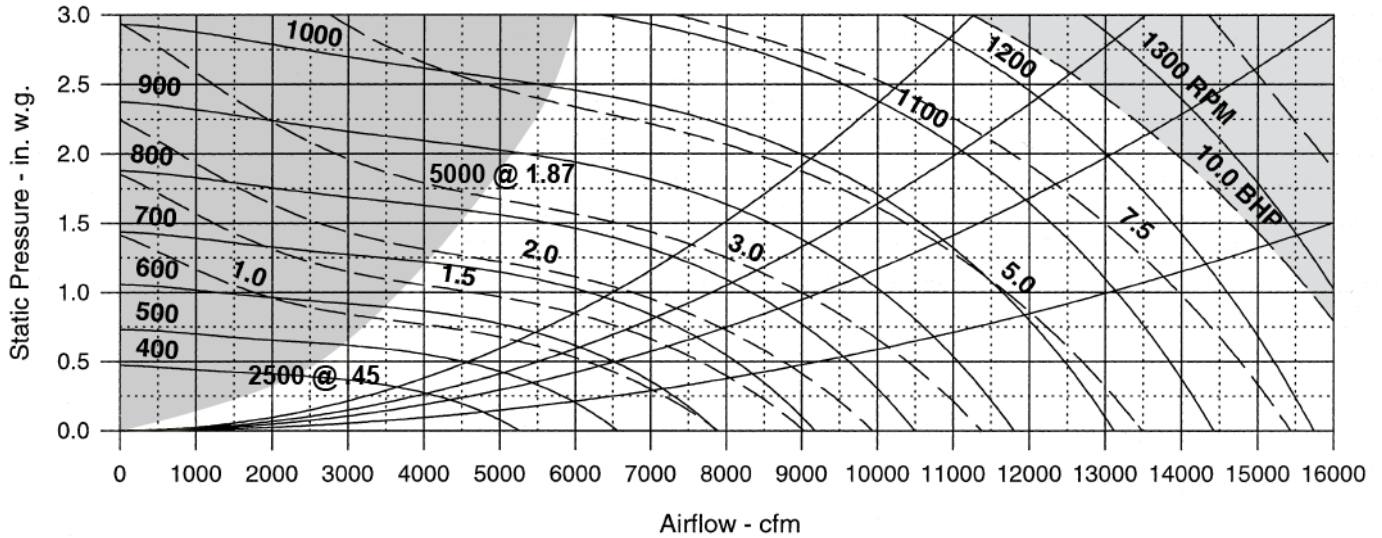

Figure 77: RPS/RFS 015D to 031D, (2) 15 in. × 15 in. Forward Curved Return Fan



Do Not Select

Figure 78: RPS/RFS 015D to 042D, 30 in. SWSI Airfoil Return Fan*



Do Not Select

*Fan curve applicable for bottom return. Back return corrections are listed below.

Back Return Performance Correction

For 30 in. airfoil fan with back return, add the following static pressure drop to the design return duct static pressure drop. Enter Figure 78 at this greater static pressure and the design airflow to determine actual back return performance.

Table 30: Additional Back Return Static Pressure, 30 in. Airfoil Return Fan

Airflow (cfm)	4,000	6,000	8,000	10,000	12,000	14,000
Back return SP (in. W.G.)	0.05	0.12	0.21	0.33	0.48	0.65

Figure 79: RPS/RFS/RDT 035D to 042D, 40 in. SWSI Airfoil Return Fan (Bottom Return Only)

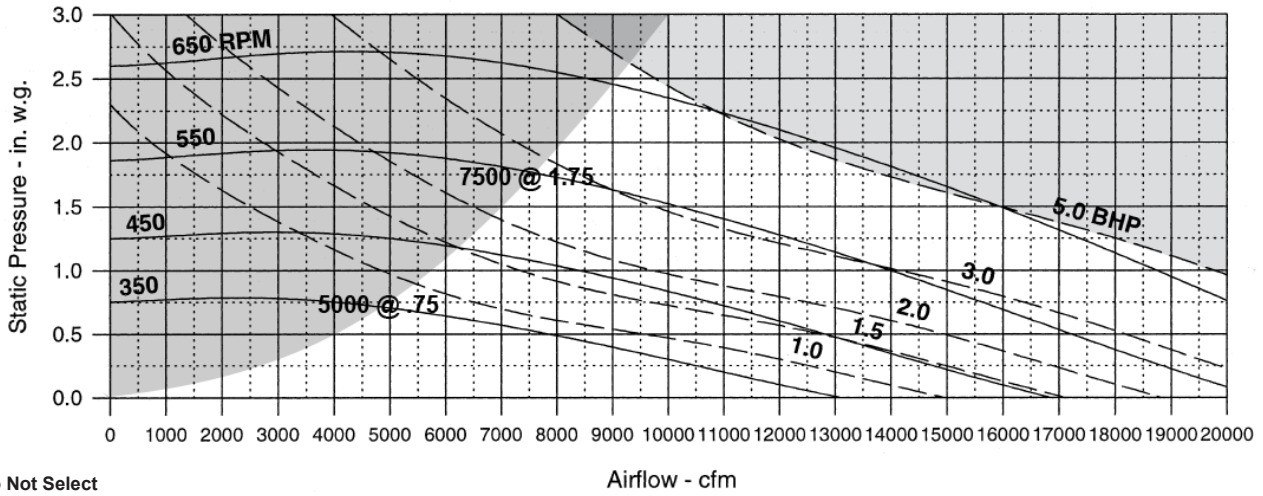

Figure 80: RPS/RFS/RDT 045D to 079D, 40 in. SWSI Airfoil Return Fan

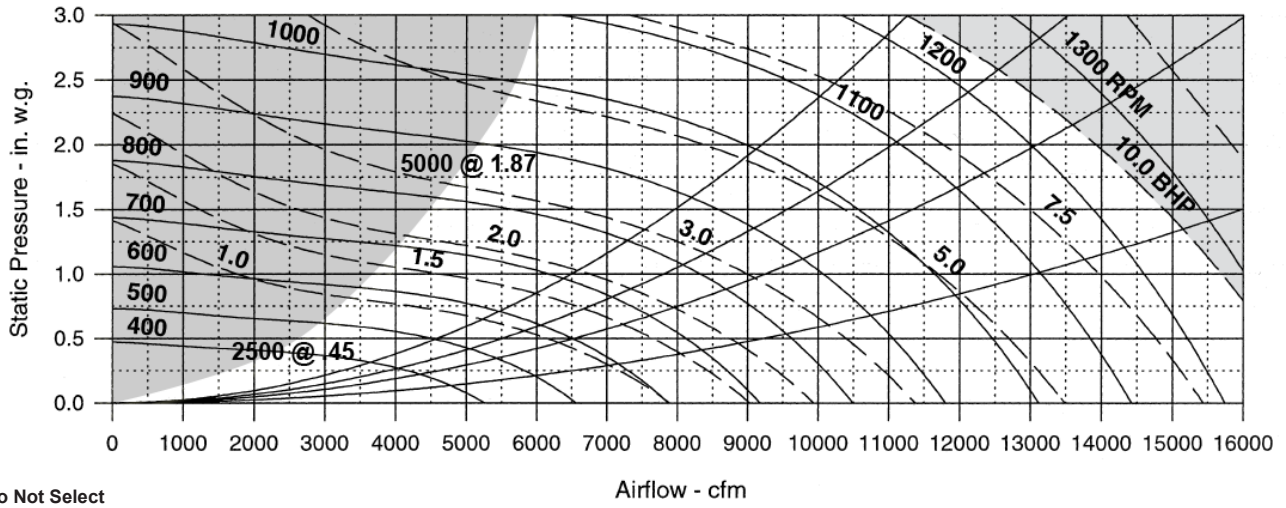
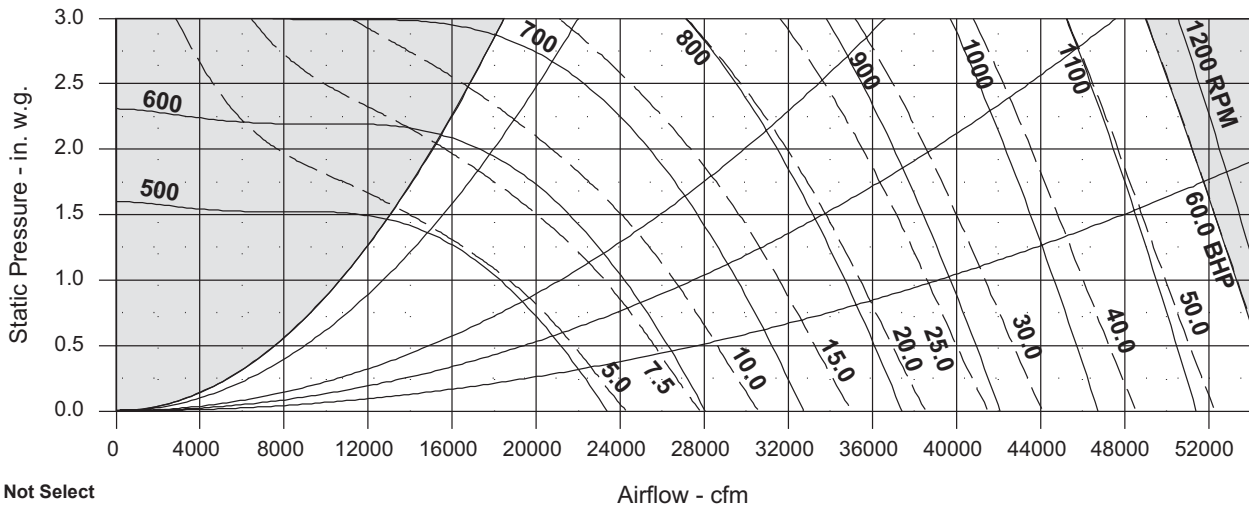

Figure 81: RPS/RFS/RDT 080D to 140D, 44 in. SWSI Airfoil Return Fan



Section Options and Locations

Figure 82—Figure 90 show section options, curb lengths, and relative positions. Curb lengths (in inches) are shown below each icon.

Figure 82: RPS/RFS/RCS 015D to 031D, Draw-Through Coil Section









































































Position A Outdoor/ Return Air Mandatory	Position B Filter Mandatory	Position C Blank (Optional)	Position E Blank (Optional)	Position F Draw-through Clg/Supply Air Fan Mandatory	Position G Heat/Blank (Optional)	Position H Blank (Optional)	Position I Blank w/Drain Pan (Optional)	Position J Final Filter (Optional)	Position K Discharge Plenum Mandatory	Position L Blank Compartment (Optional)	Position M Air-Cooled Condenser
 <p>0</p>	 <p>22</p>	 <p>40</p>	 <p>40</p>	<p>(2) 15" FC with DX Coil 18.5 sq. ft. 015-020 27.0 sq. ft. 025-030</p>  <p>40</p>	<p>Steam/ Hot Water 20.3 sq.ft.</p>  <p>40</p>	 <p>40</p>	 <p>40</p>	<p>W/Cig Only, Steam or Hot Water Heat 24 sq.ft.</p>  <p>28</p>	 <p>40</p>	 <p>40</p>	 <p>61 (015-025) (Does not affect curb length)</p>
 <p>40</p>	<p>Cartridge 24 sq. ft.</p>  <p>28</p>	 <p>52</p>	 <p>52</p>	<p>20" AF with DX Coil 18.5 sq. ft. 015-020 27.0 sq. ft. 025-030</p>  <p>52</p>	<p>Electric</p>  <p>40</p>	 <p>52</p>	 <p>52</p>	<p>W/ Gas or Electric Heat 24 sq.ft.</p>  <p>52</p>	 <p>52</p>	 <p>83 (030) (Does not affect curb length)</p>	 <p>83 (030) (Does not affect curb length)</p>
<p>30% OA</p>  <p>40</p>	<p>Blank Access</p>  <p>22</p>	<p>VFD Section</p>  <p>52</p>	 <p>52</p>	<p>Gas 200-1000 mbh</p>  <p>40</p>	 <p>40</p>	 <p>52</p>	 <p>52</p>	 <p>28</p>	 <p>28</p>	 <p>106 (016, 021, 026, 031)</p>	 <p>106 (016, 021, 026, 031)</p>
<p>Economizer</p>  <p>40</p>	<p>Blank Access</p>  <p>28</p>	 <p>52</p>	 <p>52</p>	 <p>40</p>	 <p>40</p>	 <p>52</p>	 <p>52</p>	 <p>52</p>	 <p>52</p>	 <p>52</p>	 <p>52</p>
<p>Economizer w/ (2) 15"x15" FC Return Fan</p>  <p>62</p>	<p>Blender & Angular Filter</p>  <p>74</p>	 <p>52</p>	 <p>52</p>	 <p>40</p>	 <p>40</p>	 <p>52</p>	 <p>52</p>	 <p>52</p>	 <p>52</p>	 <p>52</p>	 <p>52</p>
<p>Economizer with 30" AF Return Fan</p>  <p>52</p>	<p>Blender & Cartridge Filter</p>  <p>80</p>	 <p>52</p>	 <p>52</p>	 <p>40</p>	 <p>40</p>	 <p>52</p>	 <p>52</p>	 <p>52</p>	 <p>52</p>	 <p>52</p>	 <p>52</p>

Figure 83: RPS/RFS/RCS 035D and 042D, Blow-Through Coil Section (NA Final Filters)











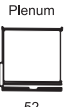

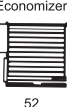

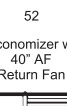
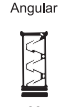









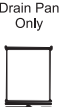

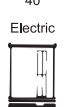

Position A Outdoor/ Return Air Mandatory	Position B Filter Mandatory	Position C Blank Optional	Position D Blank w/Drain Pan Optional	Position E Blank Optional	Position F Supply Air Fan Mandatory	Position G Heat/Blank Mandatory	Position H Blank Optional	Position I DX Coil Mandatory	Position J Blank Optional	Position K Discharge Plenum Mandatory	Position L Blank Compartment Optional	Position M Air-cooled Condenser
 0  52  52  52  52  80	Angular  22 Cartridge 24 sq. Ft.  28 Blank Access  22 Blank Access  28 Blender & Angular Filter  74 Blender & Cartridge Filter  80	Blank Access  40 Blank Access  52 VFD Section  52  52	Drain Pan Only  40	Blank Access  40	24" Dia  62	Steam/ Hot Water  40 Electric  40 Gas  40 Blank Access  40	Blank Access  40 Blank Access  52 Sound Attenuator  52  52	DX Coil 27.0 sq. Ft.  22	Blank Access  28 Blank Access  52	Discharge Plenum  40	Compartment (out of airstream)  40	Air-cooled Condenser  83 (Does Not Affect Curb Length)  106 (042)

Figure 84: RPS/RFS/RCS 035D and 042D, Draw-Through Coil Section







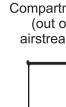
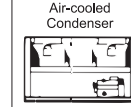
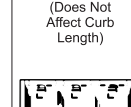



































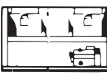

























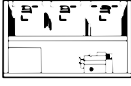





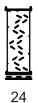
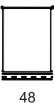

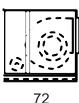

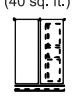
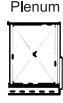
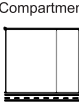



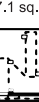

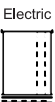
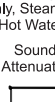

Position A Outdoor/ Return Air Mandatory	Position B Filter Mandatory	Position C Blank Optional	Position D DX Coil Mandatory	Position E Blank Optional	Position F Supply Air Fan Mandatory	Position G Heat/Blank Optional	Position H Blank Optional	Position I Blank w/Drain Pan Optional	Position J Final Filter Optional	Position K Discharge Plenum Mandatory	Position L Blank Compartment Optional	Position M Air-cooled Condenser
<p>OA Hood</p>  <p>0</p> <p>Plenum</p>  <p>52</p> <p>30% OA</p>  <p>52</p> <p>Economizer</p>  <p>52</p> <p>Economizer w/ 30" AF Return Fan</p>  <p>52</p> <p>Economizer w/ 40" AF Return Fan</p>  <p>80</p>	<p>Angular</p>  <p>22</p> <p>Cartridge 24 sq. Ft.</p>  <p>28</p> <p>Blank Access</p>  <p>22</p> <p>Blank Access</p>  <p>28</p> <p>Blender & Angular Filter</p>  <p>74</p> <p>Blender & Cartridge Filter</p>  <p>80</p>	<p>Blank Access</p>  <p>40</p> <p>Blank Access</p>  <p>52</p> <p>VFD Section</p>  <p>52</p>	<p>DX Coil 27.0 sq. Ft.</p>  <p>22</p>	<p>Blank Access</p>  <p>40</p>	<p>24" Dia</p>  <p>62</p>	<p>Steam/ Hot Water 20.3 sq. Ft.</p>  <p>40</p> <p>Electric</p>  <p>40</p> <p>Gas 200-1000 mbh</p>  <p>40</p> <p>Blank Access</p>  <p>40</p>	<p>Blank Access</p>  <p>40</p> <p>Blank Access</p>  <p>52</p> <p>Sound Attenuator</p>  <p>52</p>	<p>Drain Pan Only</p>  <p>40</p>	<p>W/Cig Only, Steam or Hot Water Heat 24 sq. Ft.</p>  <p>28</p> <p>W/ Gas or Elec. Heat 24 sq. Ft.</p>  <p>52</p> <p>Blank Access</p>  <p>28</p> <p>Blank Access</p>  <p>52</p>	<p>Discharge Plenum</p>  <p>40</p>	<p>Compartment (out of airstream)</p>  <p>40</p>	<p>Air-cooled Condenser</p>  <p>83 (Does Not Affect Curb Length)</p>  <p>106 (042)</p>

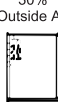
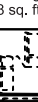
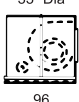
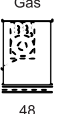
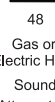
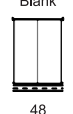
Figure 85: RPS/RFS/RCS 045D to 079D, Blow-Through Coil Section (NA Final Filters)

Position A Outdoor/ Return Air Mandatory	Position B Filter Mandatory	Position C Blank Optional	Position F Supply Air Fan Mandatory	Position G Heat Mandatory	Position H Blank Optional	Position I DX Coil Mandatory	Position K Discharge Plenum Mandatory	Position L Blank Compartment Optional	Position M Air-cooled Condensing Unit
Outdoor Air Hood  0 Plenum  48	Angular  24 Cartridge (40 sq. Ft.)  24 Cartridge (48 sq. Ft.)  48 Blender & Angular or 40 sq ft Cartridge  72 Blender & 48 sq ft Cartridge  96 Blank  24 or 48	Blank  48 VFD Section  48	27" & 30" Dia  72 30" Dia  72 33"Dia  96	Steam/Hot Water  48 Electric  48 Gas  48 Blank  48	Blank  48 Sound Attenuator  48 Sound Attenuator*  72	(39.5 sq. ft.)  24 (47.1 sq. ft.)  48	Discharge Plenum  48	Blank Compartment  72	050D-068D Air-cooled Condenser  83 (Does not affect curb length) 051, 063, 070 thru 079D Air-cooled Condenser  106 (Does not affect curb length)
Economizer  72 Economizer w/ Return Air Fan  72 Econ w/ Prop. Exh. Fans, Bottom or Back Ret. Fans  72 Econ w/ Prop. Exh. & Side Ret. Fans  120									

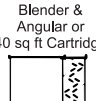
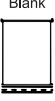
NOTE: Exhaust fan section dimensions do not include hood.

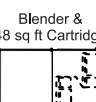
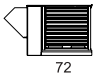
Figure 86: RPS/RFS/RCS 045D to 079D, Draw-Through Coil Section

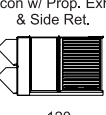
Position A Outdoor/ Return Air Mandatory	Position B Filter Mandatory	Position C Blank Optional	Position D DX Coil Mandatory	Position F Supply Air Fan Mandatory	Position G Heat Mandatory	Position H Blank Optional	Position J Final Filter Optional	Position K Discharge Plenum Mandatory	Position L Blank Compartment Optional	Position M Air-cooled Condensing Unit
Outdoor Air Hood  0	Angular  24	Blank  48	(39.5 sq. ft.)  24	27" & 30" Dia  72	Steam/ Hot Water  48	Blank  48	(40 sq. ft.)  48	Discharge Plenum  48	Blank Compartment  72	050D-068D Air-cooled Condenser  83 (Does not affect curb length)
Plenum  48	Cartridge (40 sq. ft.)  24	VFD Section  48	(47.1 sq. ft.)  48	30" Dia  72	Electric  48	Cooling Only, Steam or Hot Water Sound Attenuator  48	 72	 48	 72	051, 063, 070 thru 079D Air-cooled Condenser  106 (Does not affect curb length)
30% Outside Air  48	Cartridge (48 sq. ft.)  48			33" Dia  96	Gas  48	Gas or Electric Heat Sound Attenuator*  72	Blank  48	Blank  48	Blank  72	
Economizer  72	Blender & Angular or 40 sq ft Cartridge  72				Blank  48					
Economizer w/ Return Air Fan  72	Blender & 48 sq ft Cartridge  96									
Econ w/ Prop. Exh. Fans, Bottom or Back Ret.  72	Blank  24 or 48									
Econ w/ Prop. Exh. & Side Ret.  120										













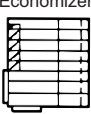

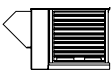





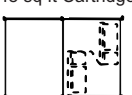

NOTE: Exhaust fan section dimensions do not include hood.
Some final filter lengths can not be reduced (consult the factory).

Example: RPS 050D with draw-through coil section

<u>Section Description</u>	<u>Length (in.)</u>
Economizer With Return Air Fan =	72
Angular Filters =	24
Cooling Coil =	24
Supply Fan =	72
Gas Heat =	48
Final Filter, Standard Flow =	48
Discharge Plenum =	48
Air Cooled Condensing Unit =	83
<u>Total Air Handler Length =</u>	<u>336</u>
Total Unit Length (including Condensing Unit) =	419





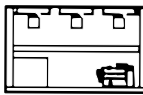







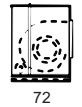













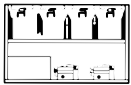

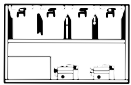

For a custom certified drawing of your specific requirements, consult your local Daikin Applied sales representative.

Figure 87: RDT 045D to 079D, Draw-Through Coil Section

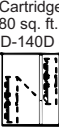
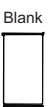
Position A Exhaust/Return Air	Position B Filter	Position C Optional Blank	Position D DX Coil	Position E Optional Heat	Position F Supply Air Fan	Position L Optional Blank Compartment	Position M Air-Cooled Condensing Unit
							050D-068D
<p>OA Hood</p>  <p>Plenum</p>  <p>48 in.</p> <p>30% OA</p>  <p>48 in.</p> <p>Economizer</p>  <p>72 in.</p> <p>Econ./RA</p>  <p>72 in.</p> <p>Econ w/ Prop. Exh. Fans, Bottom or Back Ret. Fans</p>  <p>72</p> <p>Econ w/ Prop. Exh. & Side Ret. Fans</p>  <p>120</p>	<p>TA/30</p>  <p>24 in.</p> <p>65/95 40 ft²</p>  <p>24 in.</p> <p>65/95 48 ft²</p>  <p>48 in.</p> <p>Blank</p>  <p>48 in.</p> <p>Blank</p>  <p>24 in.</p> <p>Blender & Angular or 40 sq ft Cartridge</p>  <p>72</p> <p>Blender & 48 sq ft Cartridge</p>  <p>96</p>	<p>Blank</p>  <p>48 in.</p> <p>VFD Section</p>  <p>48</p>	<p>40.1 ft²</p>  <p>24 in.</p> <p>47.4 ft²</p>  <p>48 in.</p>	<p>S&HW</p>  <p>48 in.</p> <p>Blank</p>  <p>48 in.</p>	<p>40 in. or 44 in. Dia</p>  <p>72 in.</p>	 <p>72 in.</p>	 <p>83 in.</p> <p>051, 063, 070 thru 079D</p>  <p>106 in.</p>

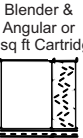

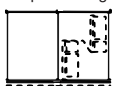
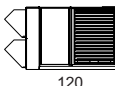
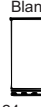















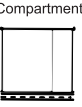



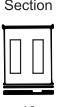



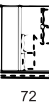





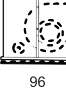



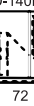

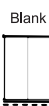
NOTE: Exhaust fan section dimensions do not include hood.

Figure 88: RPS/RFS/RCS 080D to 140D, Blow-Through Coil Section (NA Final Filters)

Position A Outdoor/ Return Air Mandatory	Position B Filter Mandatory	Position C Blank Optional	Position F Supply Air Fan Mandatory	Position G Heat Mandatory	Position H Blank Optional	Position I DX Coil Mandatory	Position K Discharge Plenum Mandatory	Position L Blank Compartment Optional	Position M Air-cooled Condensing Unit
Outdoor Air Hood  0	Angular  24	Blank  48	33" Dia  72	Steam/ Hot Water  48	Blank  48	080D-090D (53.9 sq. ft.)  24	Discharge Plenum  48	Blank Compartment  72	080D-105D Air-cooled Condenser  106 (Does not affect curb length)
Plenum  72	Cartridge (56 sq. ft.) (080D-090D only)  24	VFD Section  48	36" Dia  96	Electric  48	Sound Attenuator  48	(60.8 sq. ft.)  48			081, 091, 101, 110 thru 140D Air-cooled Condenser  139 (Does not affect curb length)
30% Outside Air  72	Cartridge (64 sq. ft.) (080D-140D only)  48		36" & 40" Dia  96	Gas  48	Sound Attenuator*  72	100D-120D (60.8 sq. ft.)  48			
Economizer  96	Cartridge (80 sq. ft.) (100D-140D only)  72			Blank  48		(76.0 sq. ft.)  72			
Economizer w/ Return Air Fan  96	Blender & Angular or 56 sq ft Cartridge  72					120D-140D (76.0 sq. ft.)  72			
Econ w/Prop. Exh. Fans, Back Ret.  72	Blender & 64 sq ft Cartridge  96								
Econ w/Prop. Exh. & Side Ret.  120	Blank  24 or 48								
Econ w/Prop. Exh. Fans & Bottom Return  96									









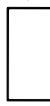

NOTE: Exhaust fan section dimensions do not include hood.

Figure 89: RPS/RFS/RCS 080D to 140D, Draw-Through Coil Section

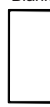
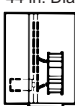
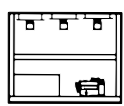
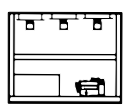
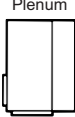
Position A Outdoor/ Return Air Mandatory	Position B Filter Mandatory	Position C Blank Optional	Position D DX Coil Mandatory	Position F Supply Air Fan Mandatory	Position G Heat Mandatory	Position H Blank Optional	Position J Final Filter Optional	Position K Discharge Plenum Mandatory	Position L Blank Compartment Optional	Position M Air-cooled Condensing Unit
Outdoor Air Hood  0	Angular  24	Blank  48	080D-090D (53.9 sq. ft.)  24	33" Dia  72	Steam/ Hot Water  48	Blank  48	(56 sq. ft.) (080D-090D only)  48	080D-090D Discharge Plenum  48	Blank Compartment  72	080D-105D  Air-cooled Condenser 108 (Does not affect curb length)
Plenum  72	Cartridge (56 sq. ft.) (080D-090D only)  24	VFD Section  48	(60.8 sq. ft.)  48	36" Dia  96	Electric  48	Cooling Only, Steam or Hot Water Sound Attenuator  48	(64 sq. ft.)  72	100D-140D  72		081, 091, 101, 110 thru 140D  Air-cooled Condenser 139 (Does not affect curb length)
30% Outside Air  72	Cartridge (64 sq. ft.) (080D-140D only)  48		100D-120D (60.8 sq. ft.)  48	36" & 40" Dia  96	Gas  48	Gas or Electric Heat Sound Attenuator*  48	(80 sq. ft.) (100D-140D only)  96			
Economizer  96	Cartridge (80 sq. ft.) (100D-140D only)  72		(76.0 sq. ft.)  72		Blank  48		Blank  48			
Economizer w/ Return Air Fan  96	Blender & Angular or 56 sq ft Cartridge  72		120D-140D (76.0 sq. ft.)  72				Blank  72			
Econ w/ Prop. Exh. Fans, Back Ret.  72	Blender & 64 sq ft Cartridge  96									
Econ w/ Prop. Exh. & Side Ret.  120	Blank  24 or 48									
Econ w/ Prop. Exh. Fans & Bottom Return  96										

NOTE: Exhaust fan section dimensions do not include hood.
Some final filter lengths can not be reduced (consult the factory).

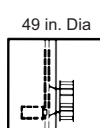
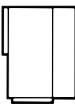
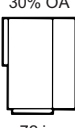
Figure 90: RDT 080D to 140D

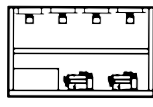
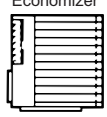
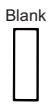
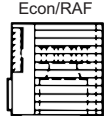
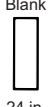
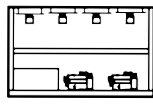
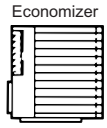
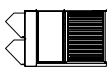
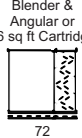
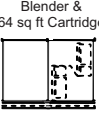
Positon A Exhaust/Return Air	Positon B Filter	Positon C Optional Blank	Positon D DX Coil	Positon E Optional Heat	Positon F Supply Air Fan	Positon L Optional Blank Compartment	Positon M Air-Cooled Condensing Unit
OA/Hood 	TA/30  24 in.	Blank  48 in.	54.7 ft ²  24 in.	S&HW  48 in. Blank  48 in.	44 in. Dia  72 in.	 72 in.	080D-105D  106 in.
Plenum  72 in.	65/95 56 ft ²  24 in.	VFD Section  48	62 ft ²  48 in.	48 in.	49 in. Dia  96 in.		081, 091, 101, 110 thru 140D
30% OA  72 in.	65/95 64 ft ²  48 in.		76.6 ft ²  72 in.				 139 in.
Economizer  96 in.	Blank  48 in.						
Econ/RAF  96 in.	Blank  24 in.						
Econ w/ Prop. Exh. Fans, Bottom or Back Ret. Fans  72	65/95 80 ft ²  72 in.						
Econ w/ Prop. Exh. & Side Ret. Fans  120	Blender & Angular or 56 sq ft Cartridge  72						
	Blender & 64 sq ft Cartridge  96						

NOTE: Exhaust fan section dimensions do not include hood.

Figure 91: RPS/RFS/RCS 015D to 031D, Basic Configuration

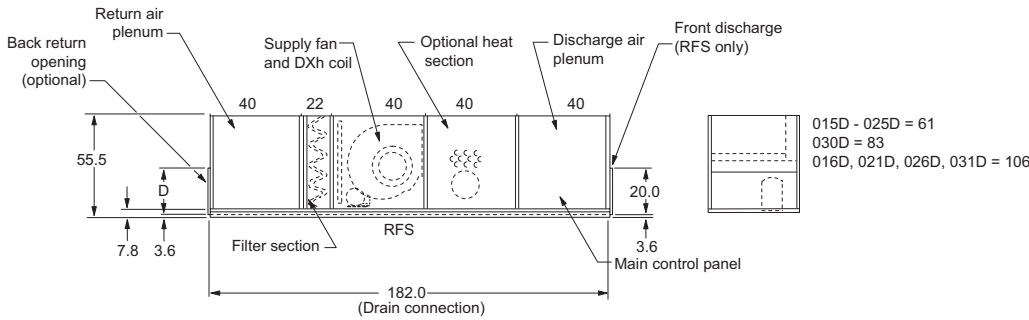
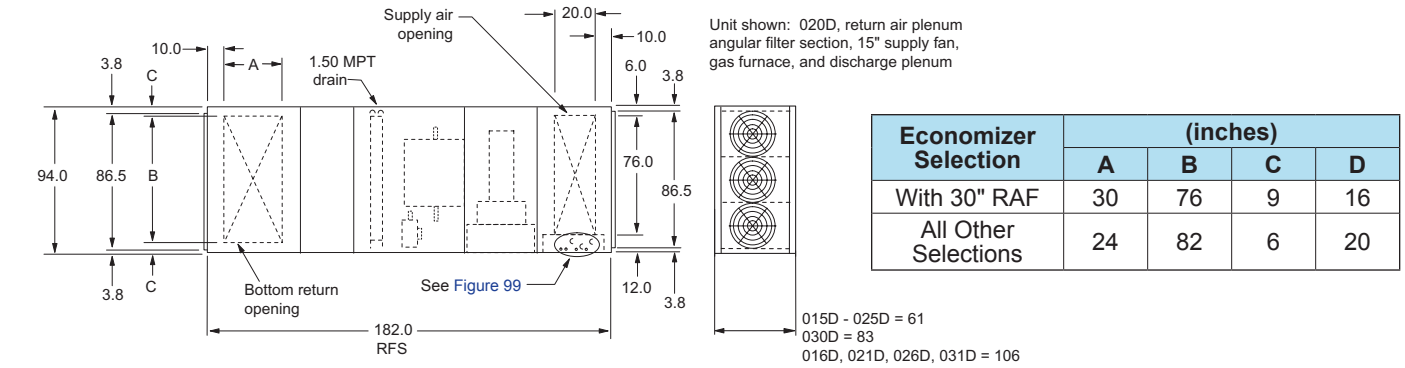

1. Unit length varies depending on the configuration (sections and options ordered). See Figure 82 for air handler section lengths.
2. Figures illustrate an RFS/RCS configuration. An RPS is a single piece.

Figure 92: RPS/RFS/RCS 035D to 042D, Basic Configuration

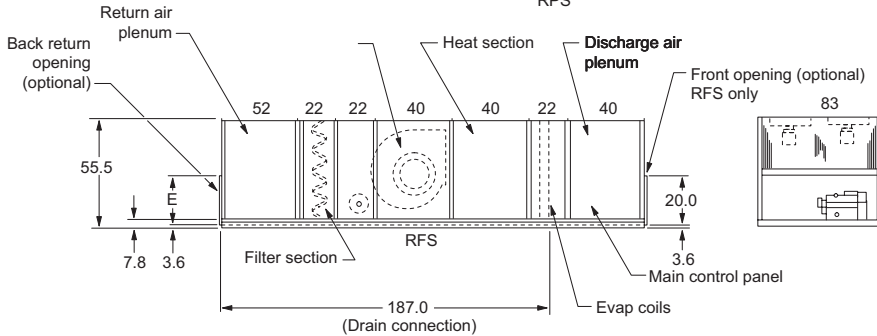
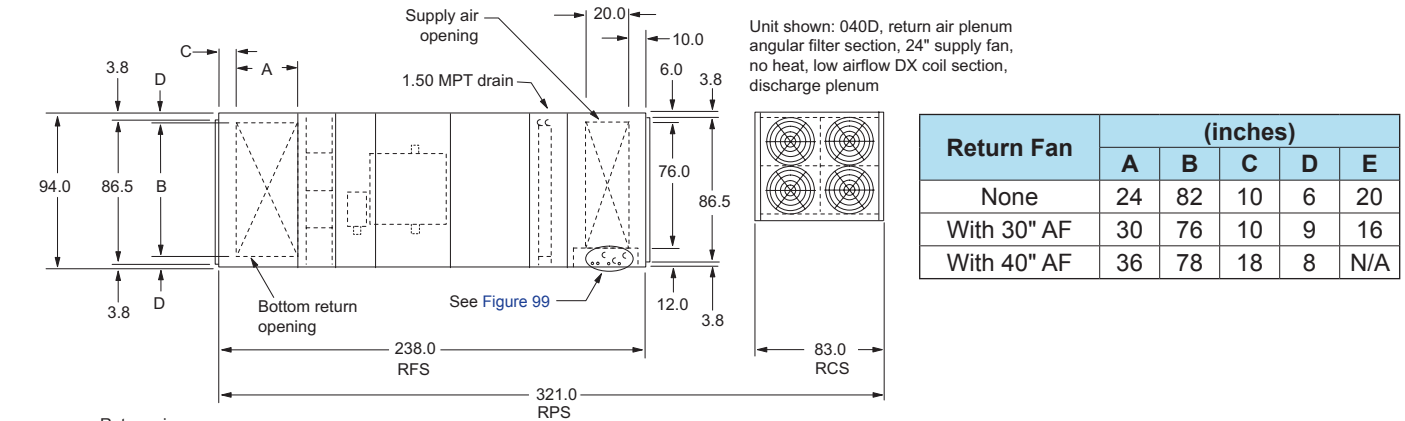

1. Unit length varies depending on the configuration (sections and options ordered). See Figure 83 and Figure 84 for air handler section lengths.
2. Figures illustrate an RFS/RCS configuration. An RPS is a single piece.

Figure 93: RPS/RFS/RCS 045D to 079D

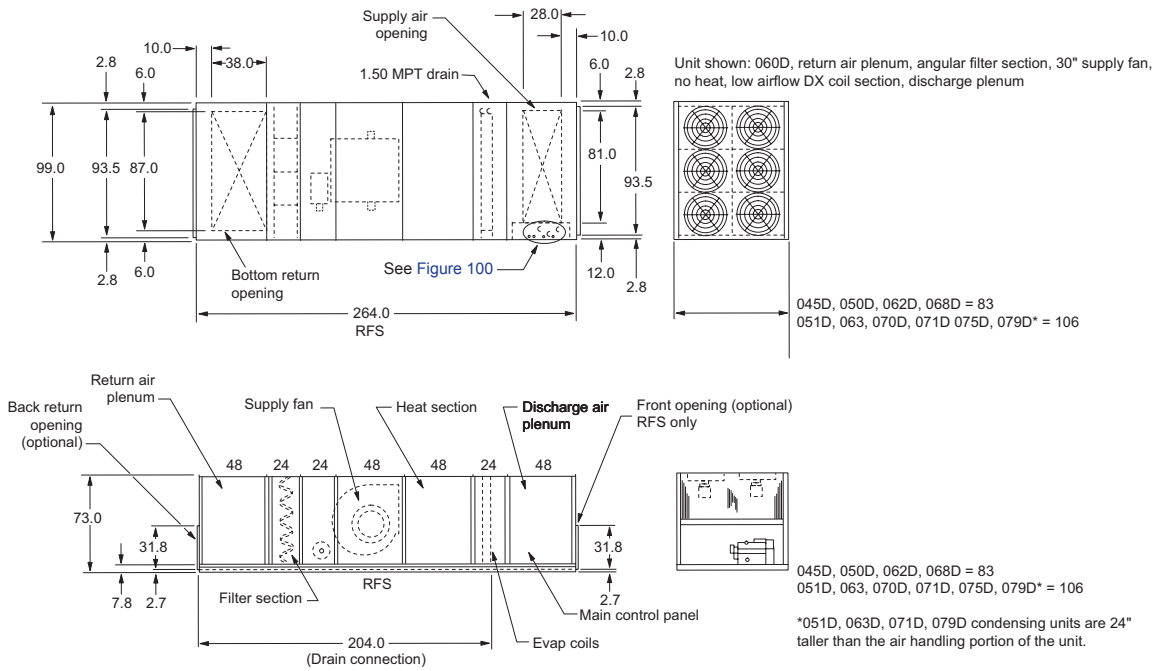

1. Unit length varies depending on the configuration (sections and options ordered). See Figure 84 through Figure 86 for air handler section lengths.
2. Figures illustrate an RFS/RCS configuration. An RPS is a single piece.

Figure 94: RPS/RFS/RCS 080D to 105D

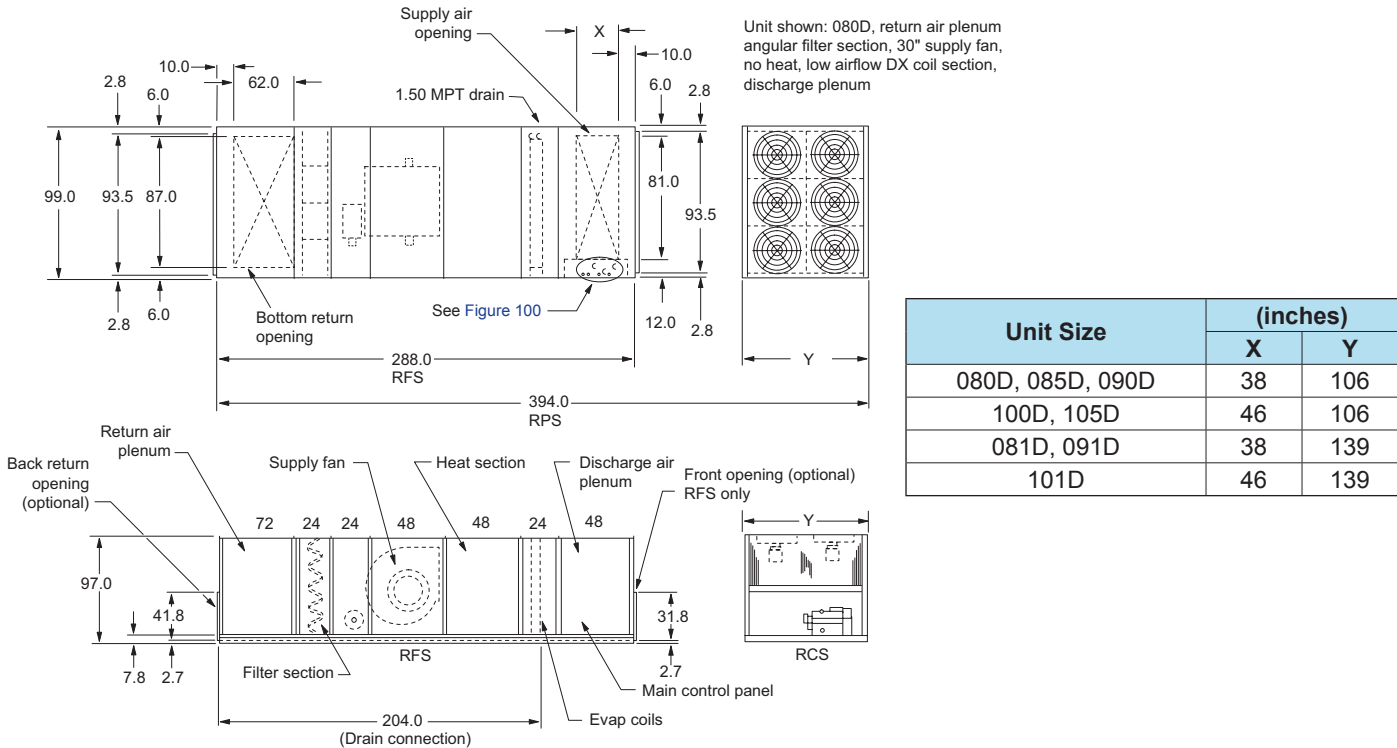

1. Unit length varies depending on the configuration (sections and options ordered). See Figure 88 through Figure 90 for air handler section lengths.
2. Figures illustrate an RFS/RCS configuration. An RPS is a single piece.

Figure 95: RPS/RFS/RCS 110D to 140D

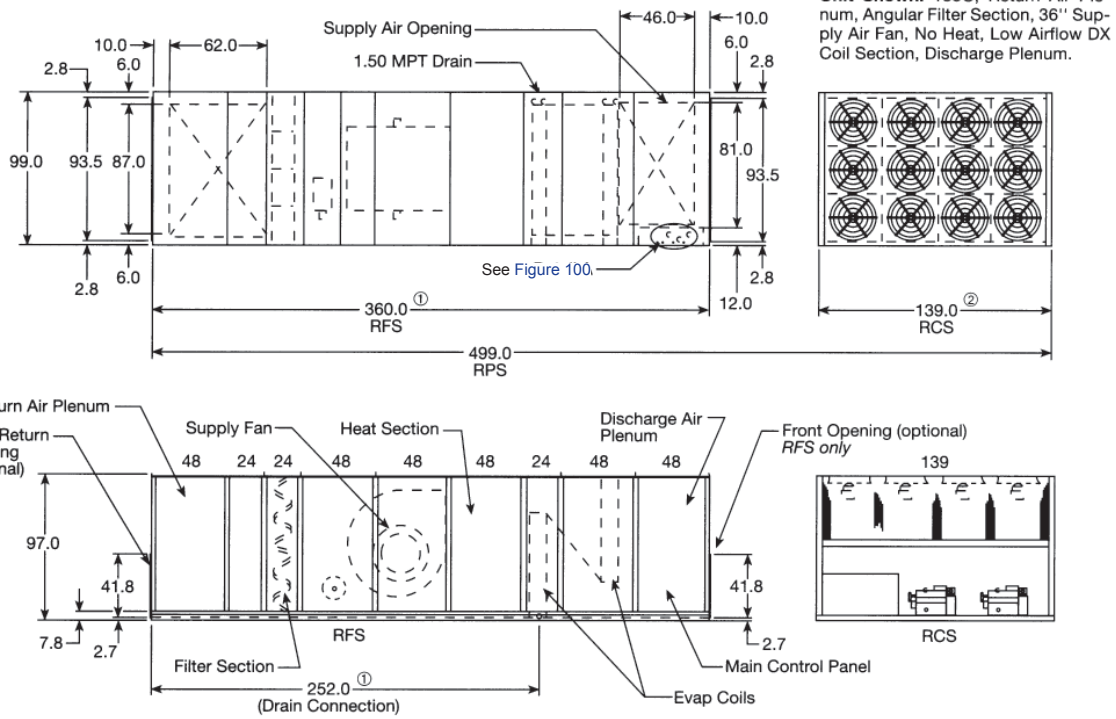

Unit Shown: 135C, Return Air Plenum, Angular Filter Section, 36" Supply Air Fan, No Heat, Low Airflow DX Coil Section, Discharge Plenum.

1. Unit length varies depending on the configuration (sections and options ordered). See Figure 88 through Figure 90 for air handler section lengths.
2. Figures illustrate an RFS/RCS configuration. An RPS is a single piece.

Figure 96: RDT 045D to 068D

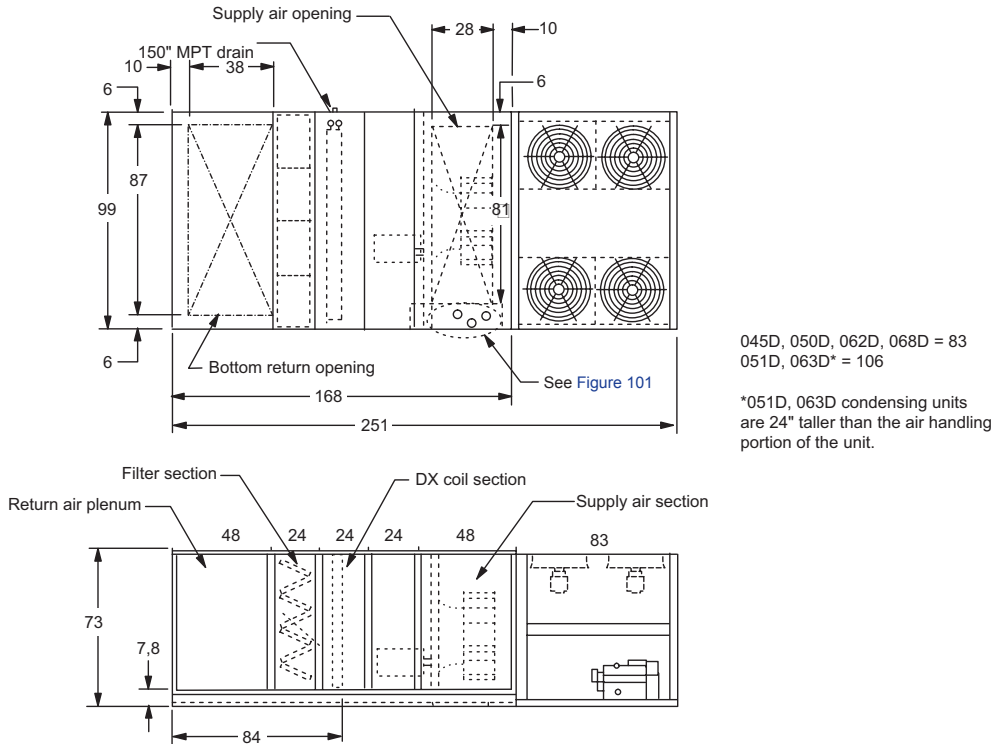

045D, 050D, 062D, 068D = 83
051D, 063D* = 106

*051D, 063D condensing units are 24" taller than the air handling portion of the unit.

1. Unit length varies depending on the configuration (sections and options ordered). See Figure 88 through Figure 90 for air handler section lengths.
2. Figures illustrate an RFS/RCS configuration. An RPS is a single piece.

Figure 97: RDT 070D to 079D

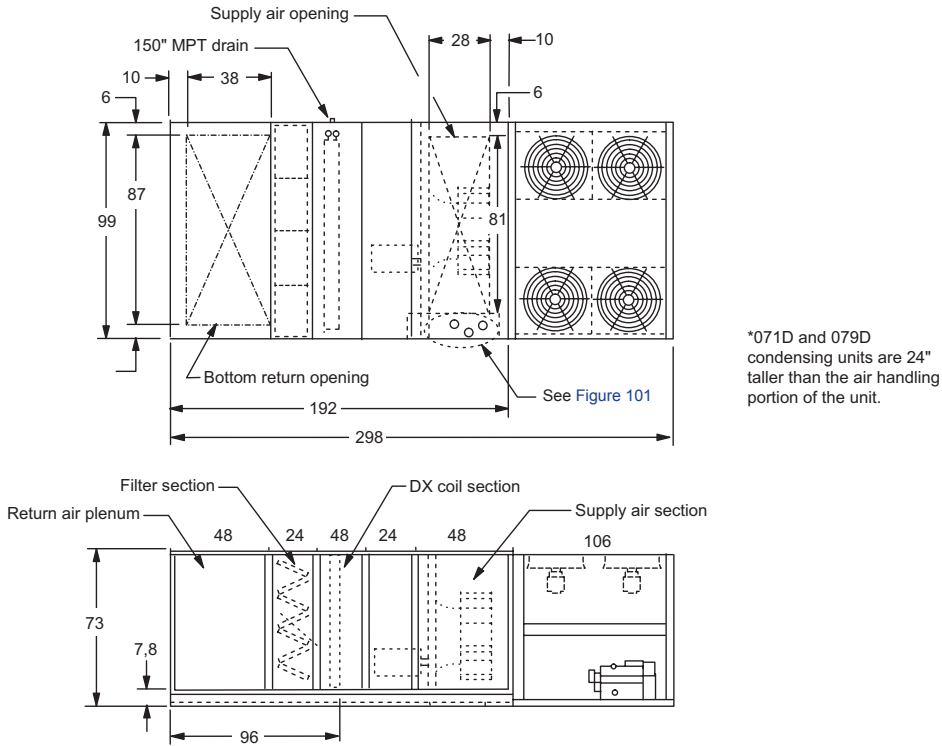

1. Unit length varies depending on the configuration (sections and options ordered). See Figure 88 through Figure 90 for air handler section lengths.
2. Figures illustrate an RFS/RCS configuration. An RPS is a single piece.

Figure 98: RDT 080D to 140D

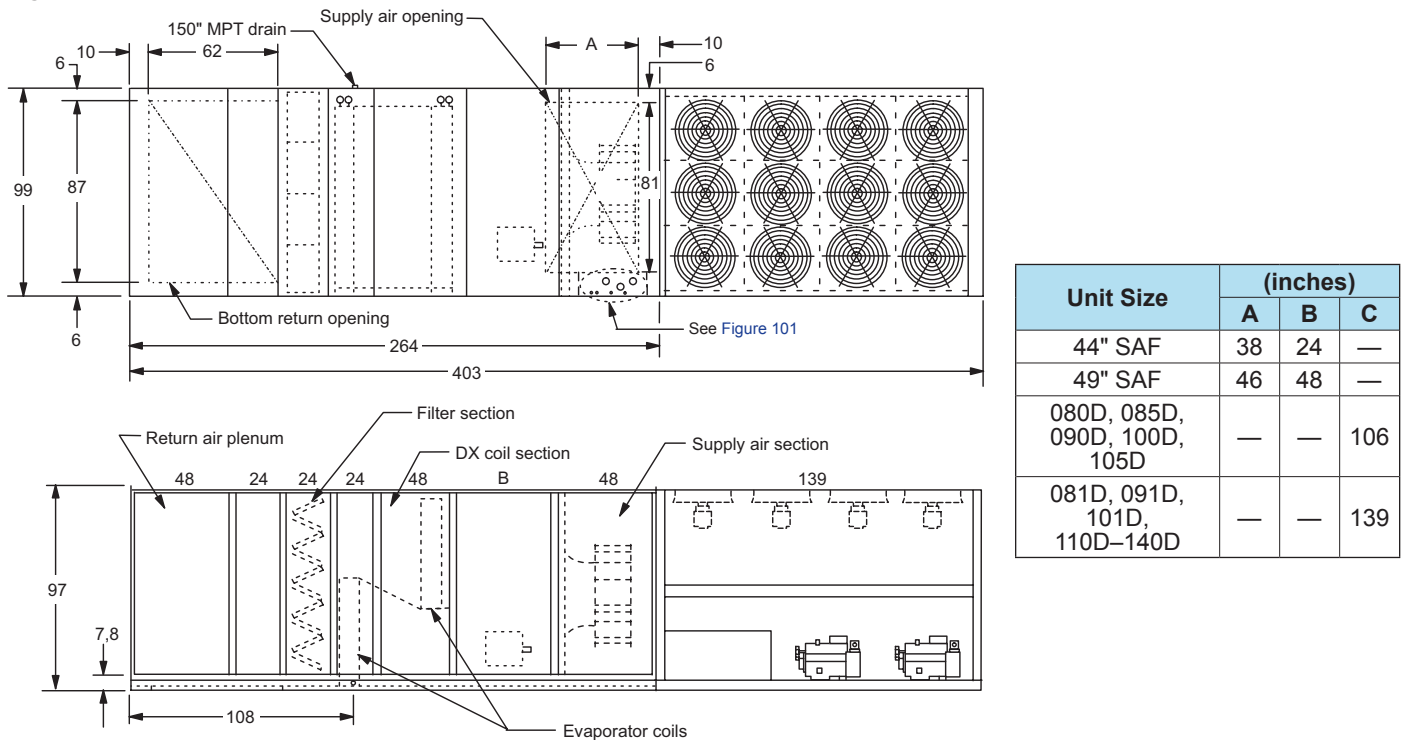

1. Unit length varies depending on the configuration (sections and options ordered). See Figure 88 through Figure 90 for air handler section lengths.
2. Figures illustrate an RFS/RCS configuration. An RPS is a single piece.

Electrical Knockout Locations

Figure 99: Main Control Panel/Discharge Plenum, RPS/RFS/RDT 015D to 042D

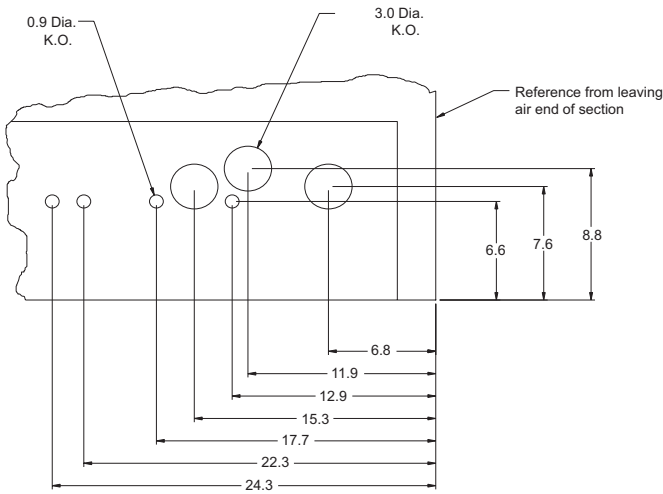

Figure 100: Main Control Panel/Discharge Plenum, RPS/RFS/RDT 045D to 140D

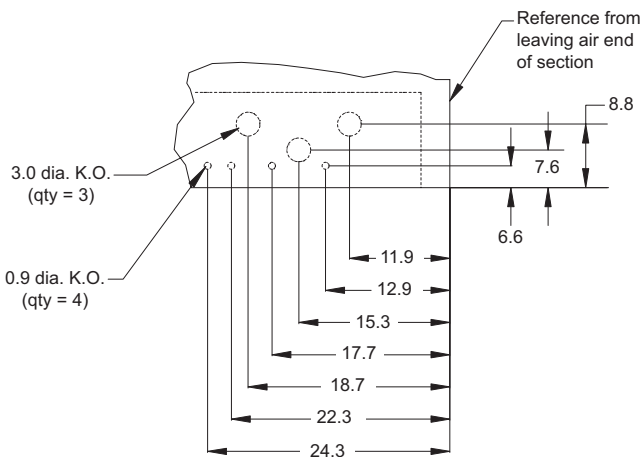
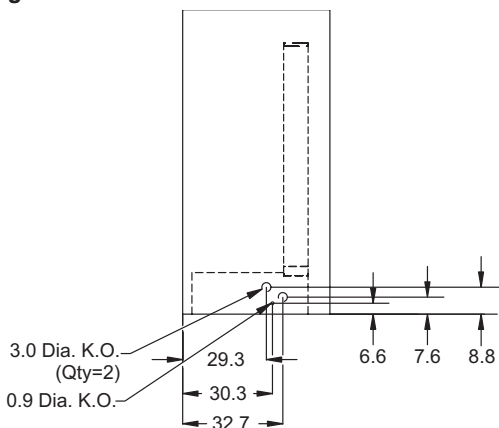

Figure 101: Electric Heat/Heat Section



Piping Entrance Locations

Figure 102: Steam and Hot Water Heat/Heat Section

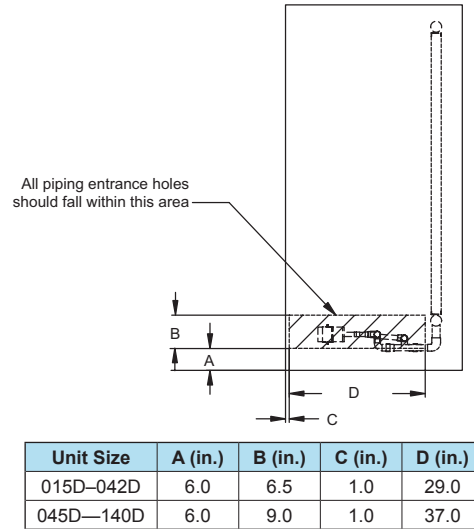

Figure 103: 200 to 1400 MBh Gas Heat/Heat Section

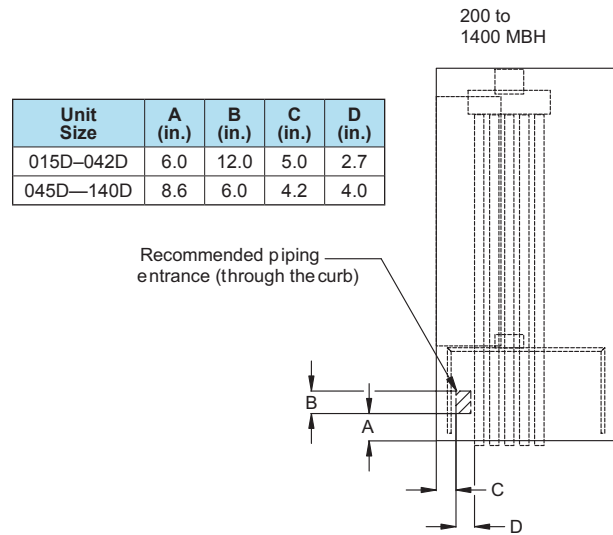

Figure 104: 1500 to 2000 MBh Gas Heat/Heat Section

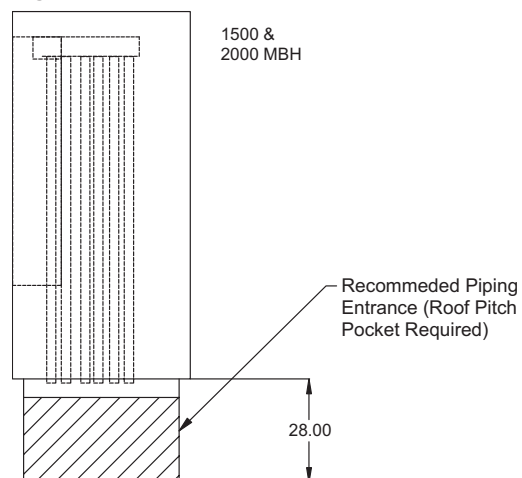

Figure 105: Side Discharge

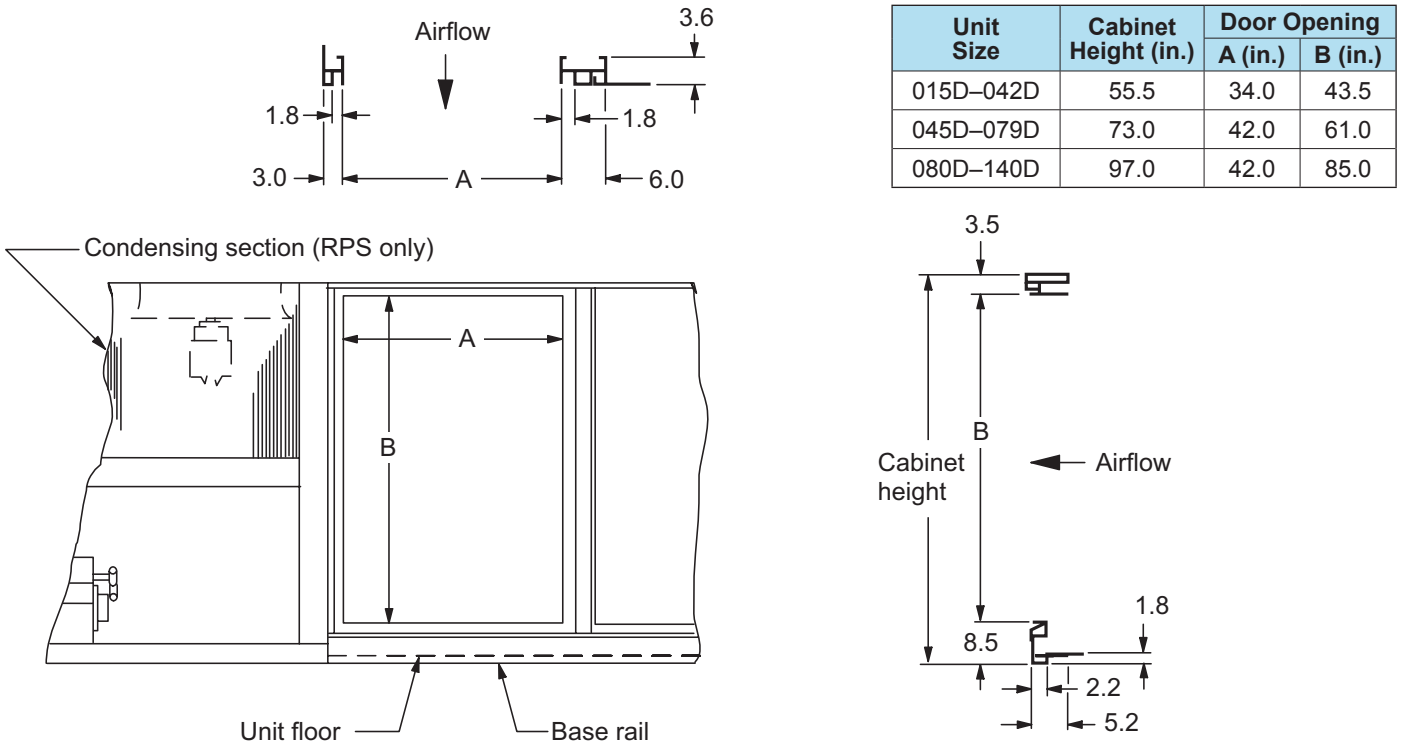

Figure 106: Internal Cabinet Clearance, Air Toward Face

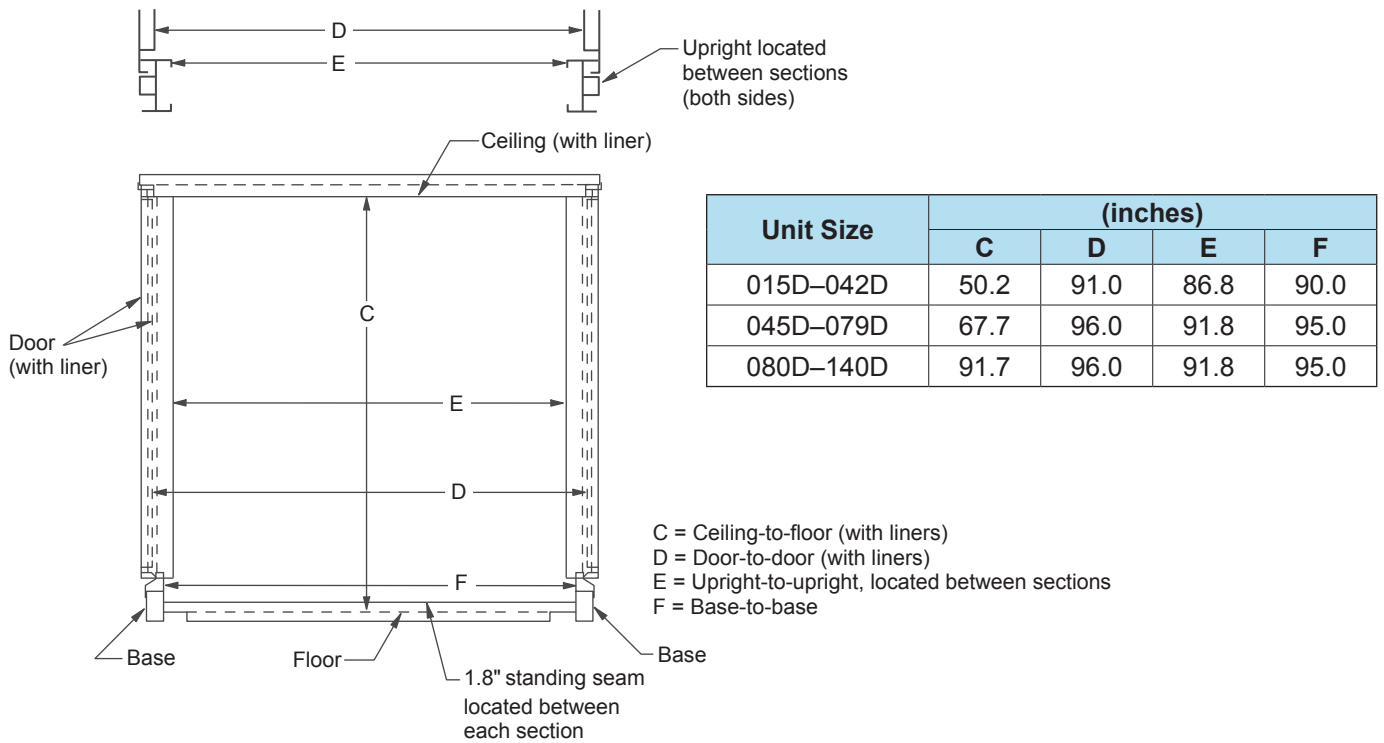

Figure 107: RPS/RFS/RDT 045D to 079D, Back Return Propeller Exhaust Fans (2 Shown, Dimensions in inches)

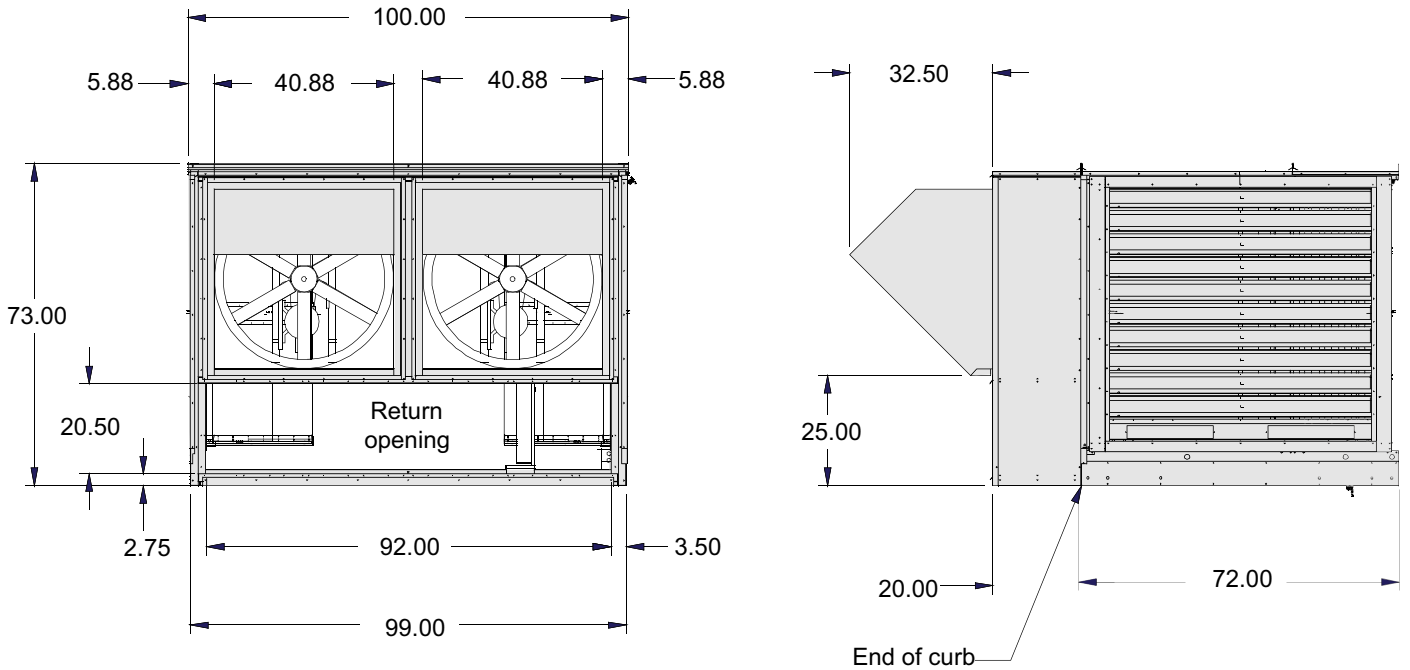
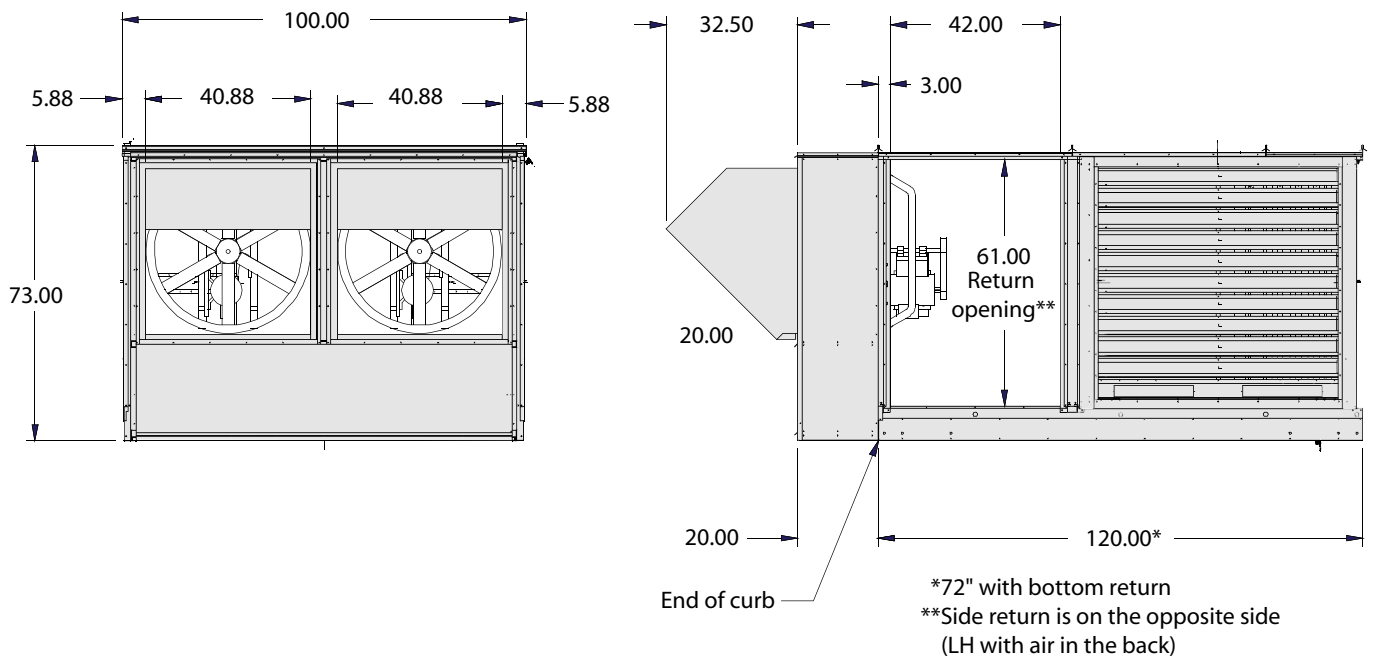

Figure 108: RPS/RFS/RDT 045D to 079D, Side Return Propeller Exhaust Fans (Dimensions in inches)



See Figures 91–95 on pages 96–98 for back return without exhaust fans.

Figure 109: RPS/RFS/RDT 080D to 140D, Back Return Propeller Exhaust Fans (Dimensions in inches)

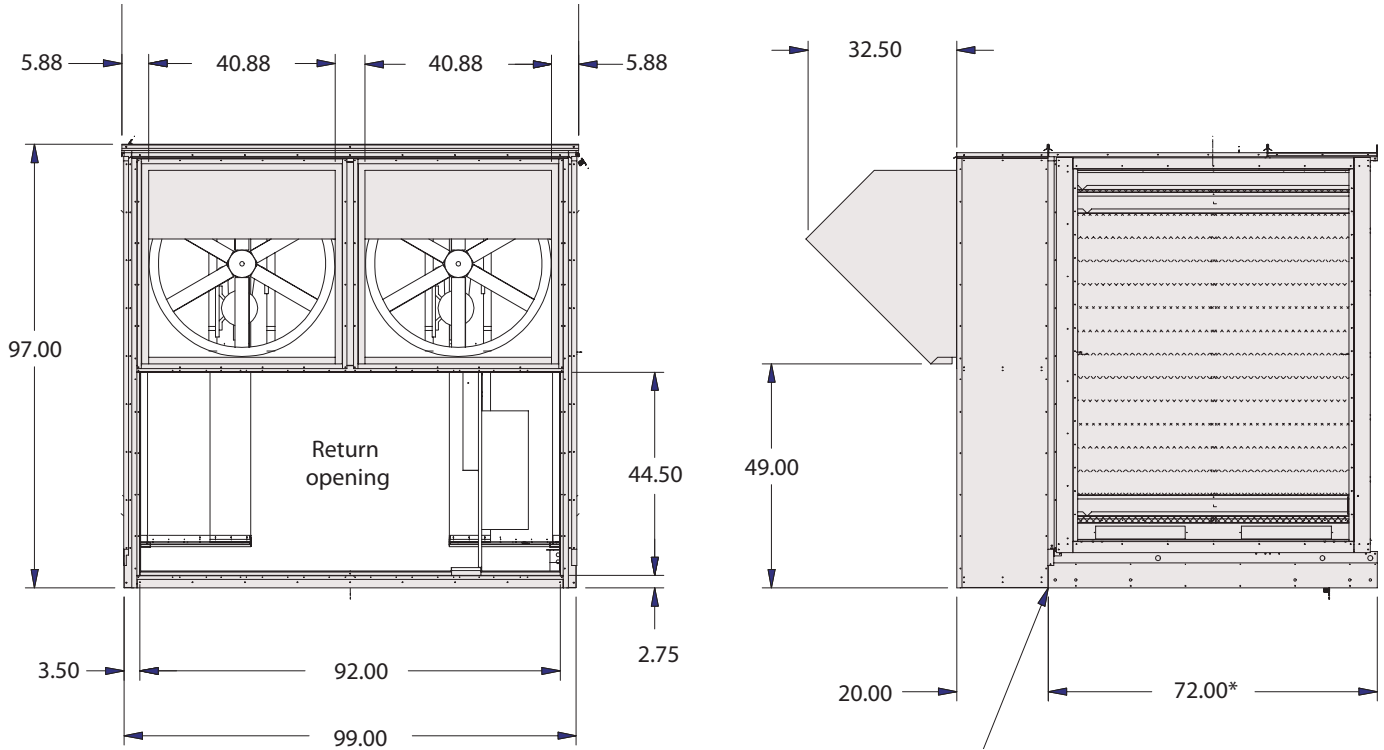

Figure 110: RPS/RFS/RDT 080D to 140D, Side Return Propeller Exhaust Fans (Dimensions in inches)

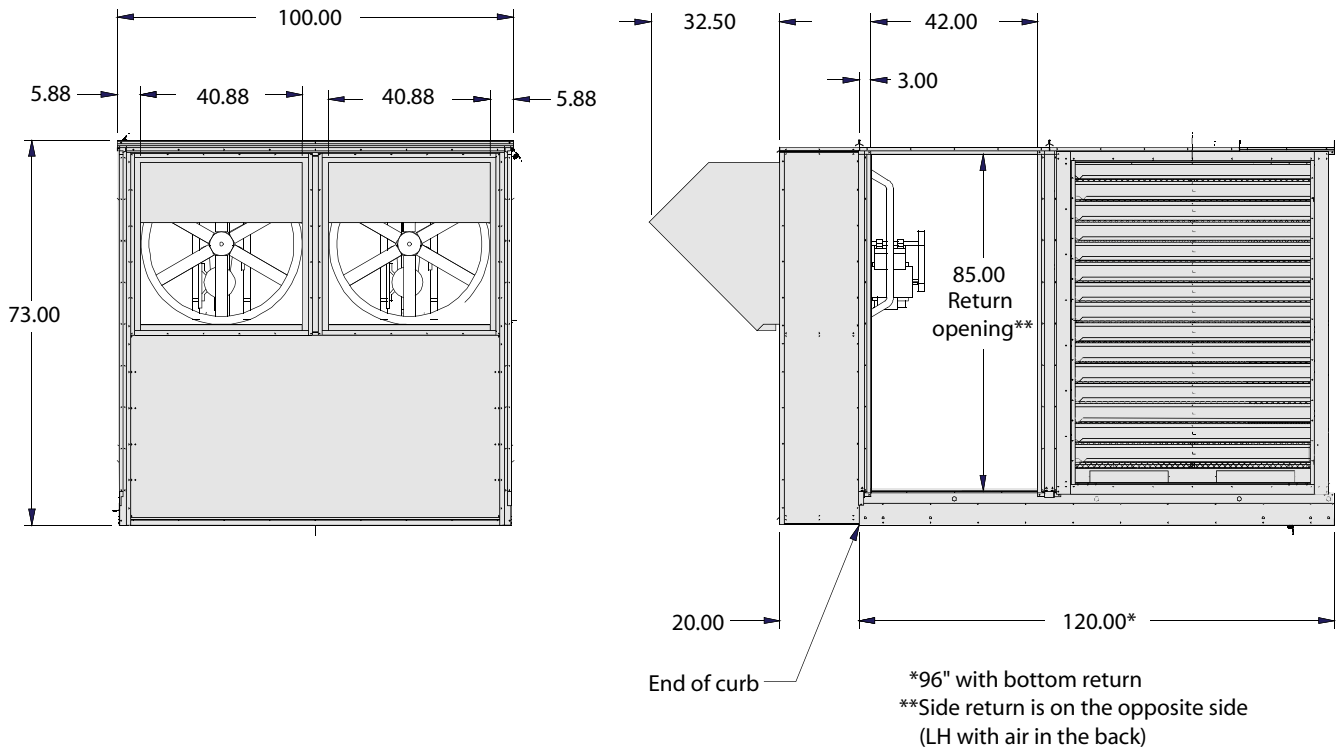
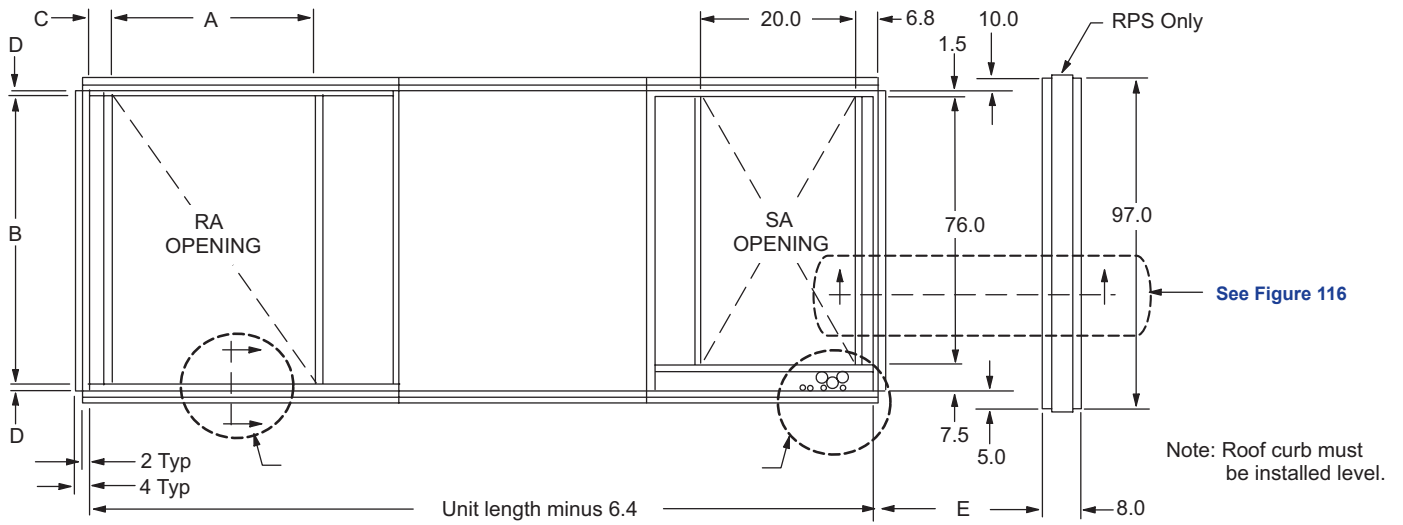
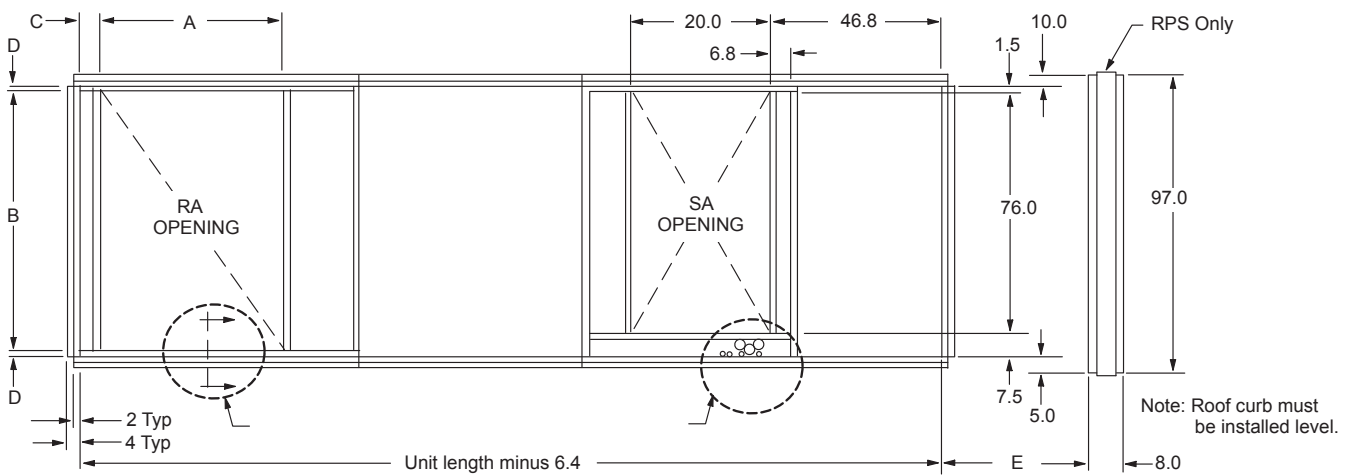

Figure 111: Roof Curb, RPS/RFS/RDT 015D to 042D (without Blank Compartment)



NOTE: Dimensions are approximate. Use certified drawings for actual construction.

Figure 112: Roof Curb, RPS/RFS/RDT 015D to 042D (with Blank Compartment)



NOTE: Dimensions are approximate. Use certified drawings for actual construction.

Table 31: RPS/RFS 015D to 040D Roof Curb Dimensions

Model	Return fan	A (in.)	B (in.)	C (in.)	D (in.)
015D to 031D	None	24	82	6.8	1.5
	(2) 15 in. FC	24	82	6.8	1.5
	30 in. AF	30	76	6.8	4.5
035D to 042D	None	24	82	6.8	1.5
	30 in. AF	30	76	6.8	4.5
	40 in. AF	36	78	14.8	3.5

Table 32: Table 65: Rail Locations

Model	E (in.)
015D, 020D, 025D	53.6
030D	56.2
035D	57.3
016D, 021D, 026D, 031D, 042D	74

Figure 113: Roof Curb, RPS/RFS/RDT 045D to 140D (without Blank Compartment)

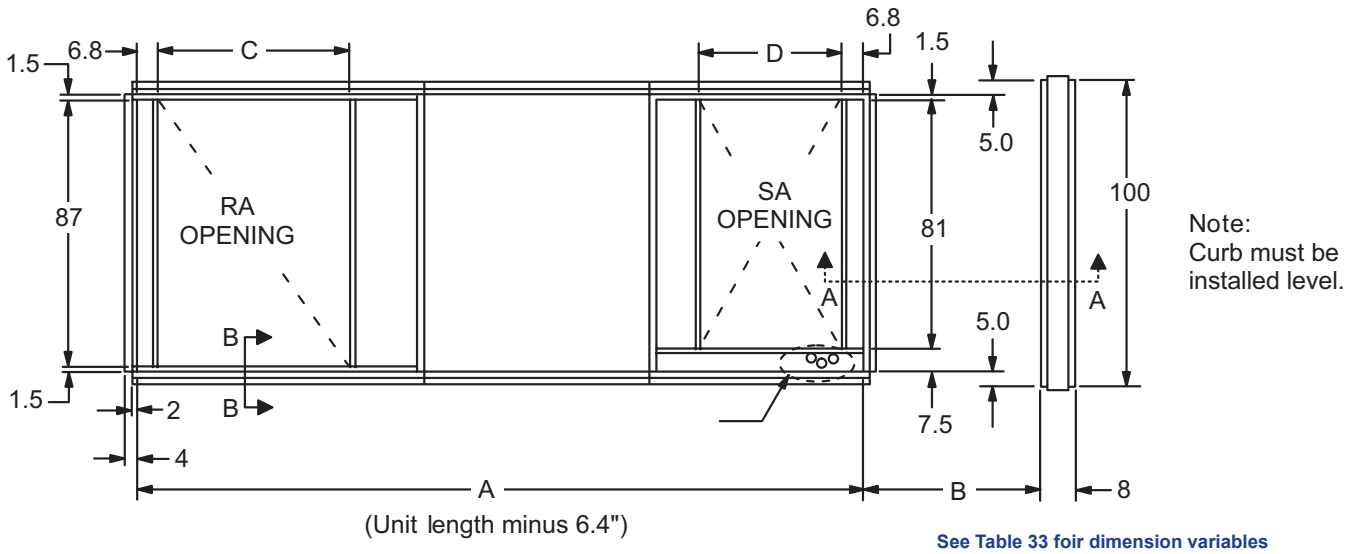

Figure 114: Roof Curb, RPS/RFS/RDT 045D to 140D (with Blank Compartment)

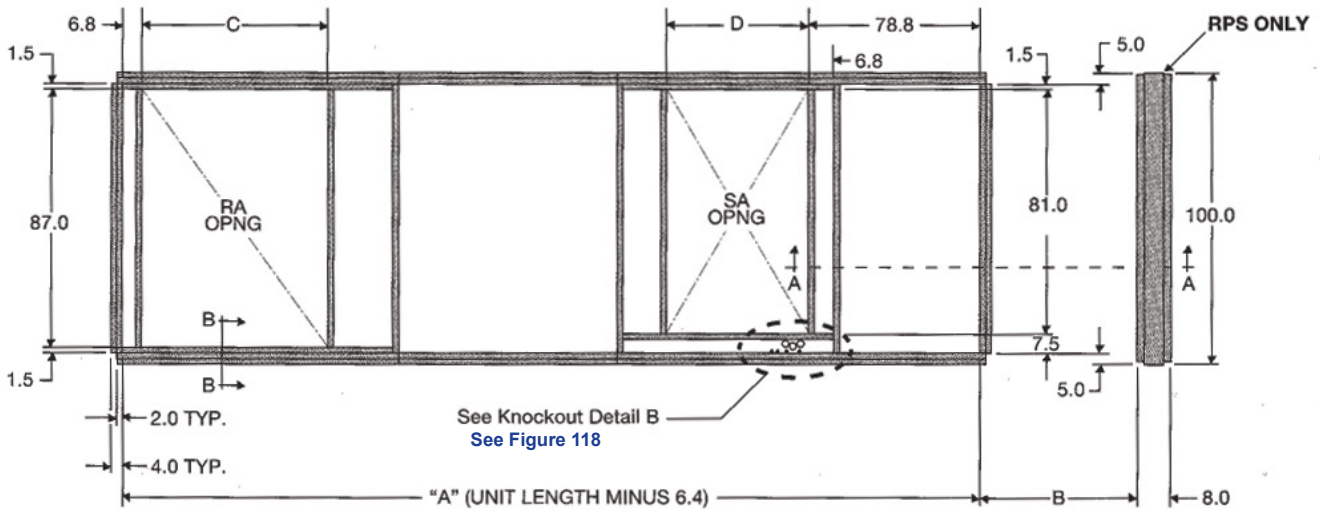

Table 33: RPS/RFS 045D to 140D Variable Dimensions

Model	Size	D Supply Air Opening	C Return Air Opening	B
RPS	045D, 050D, 061D, 068D	28	38	61
	051D, 063D, 070D, 071D, 075D, 079D	28	38	74
	080D, 085D, 090D	38	62	74
	081D, 091D	38	62	99
	101D	46	62	99
	100D, 105D	46	62	74
	110D through 140D	46	62	99

Figure 115: Curb Cross Section

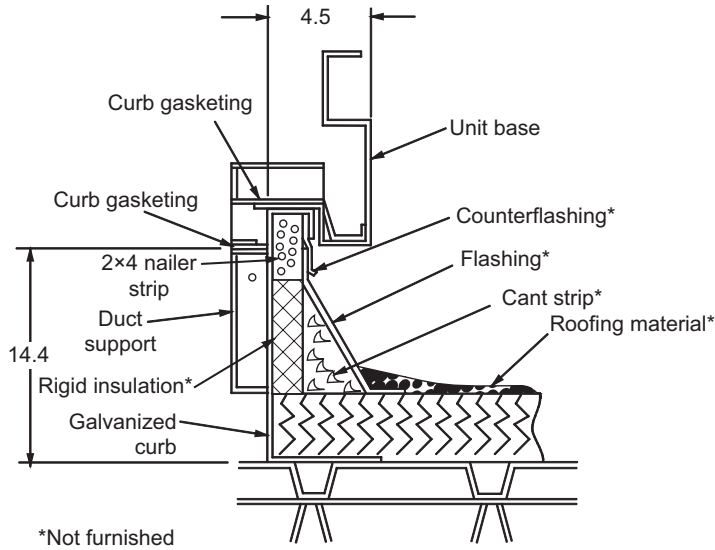

Figure 116: Curb Cross Section

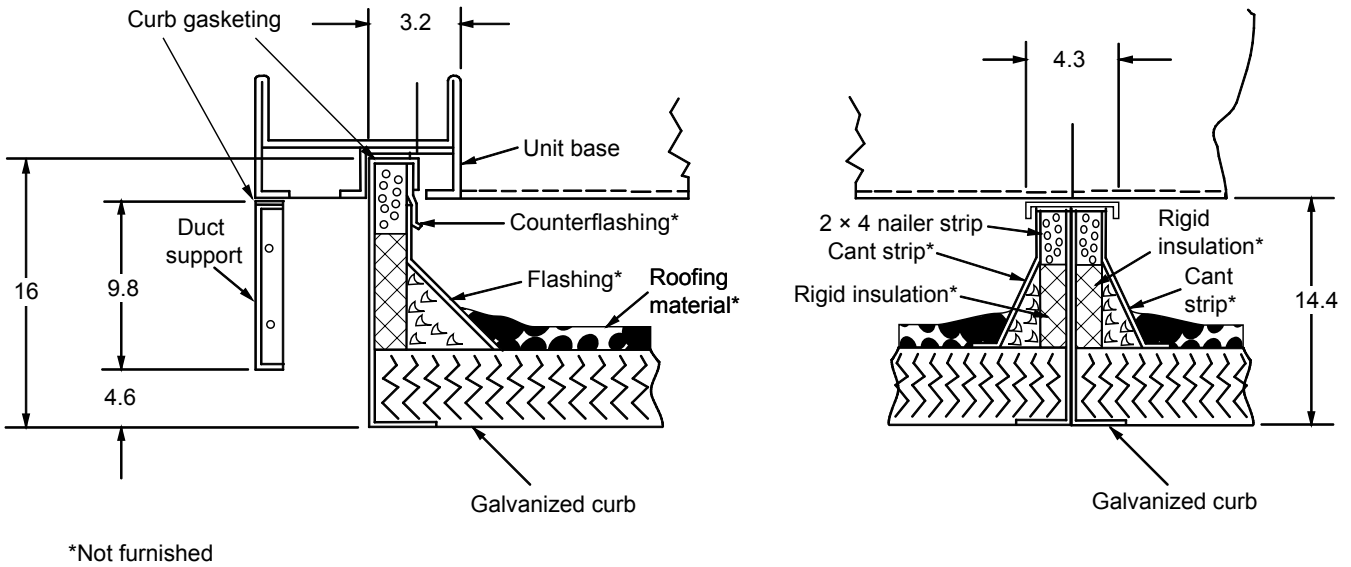

Figure 117: Knockout Detail, 025D to 042D

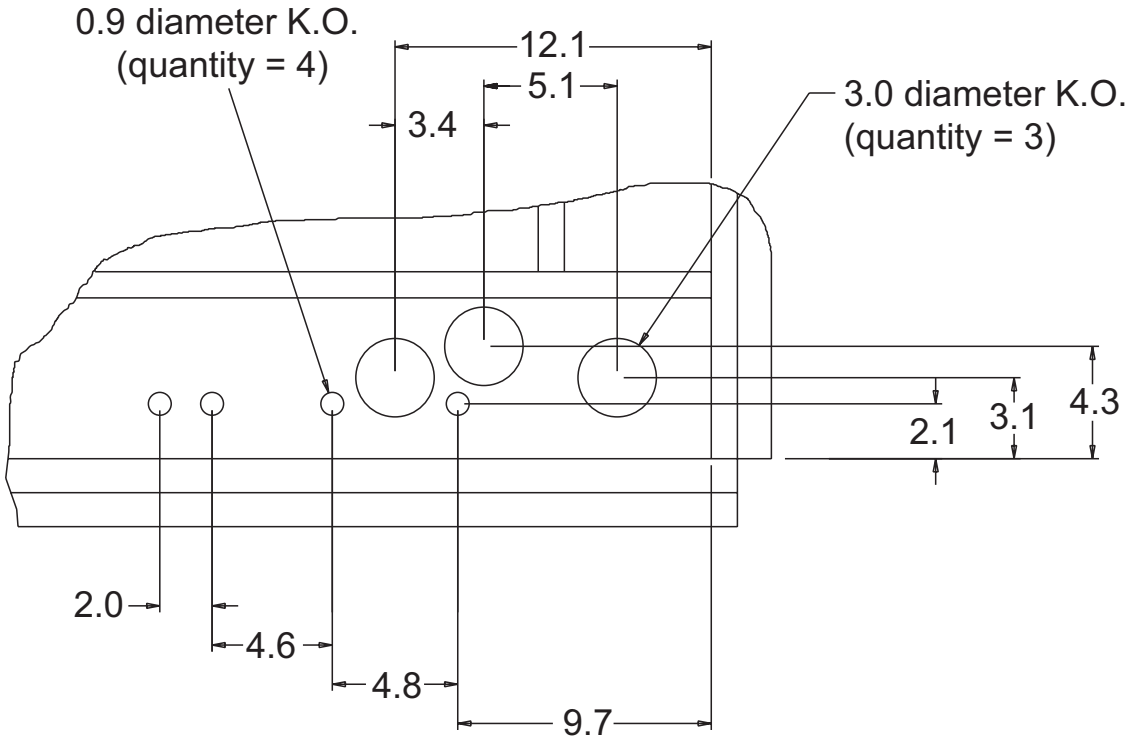
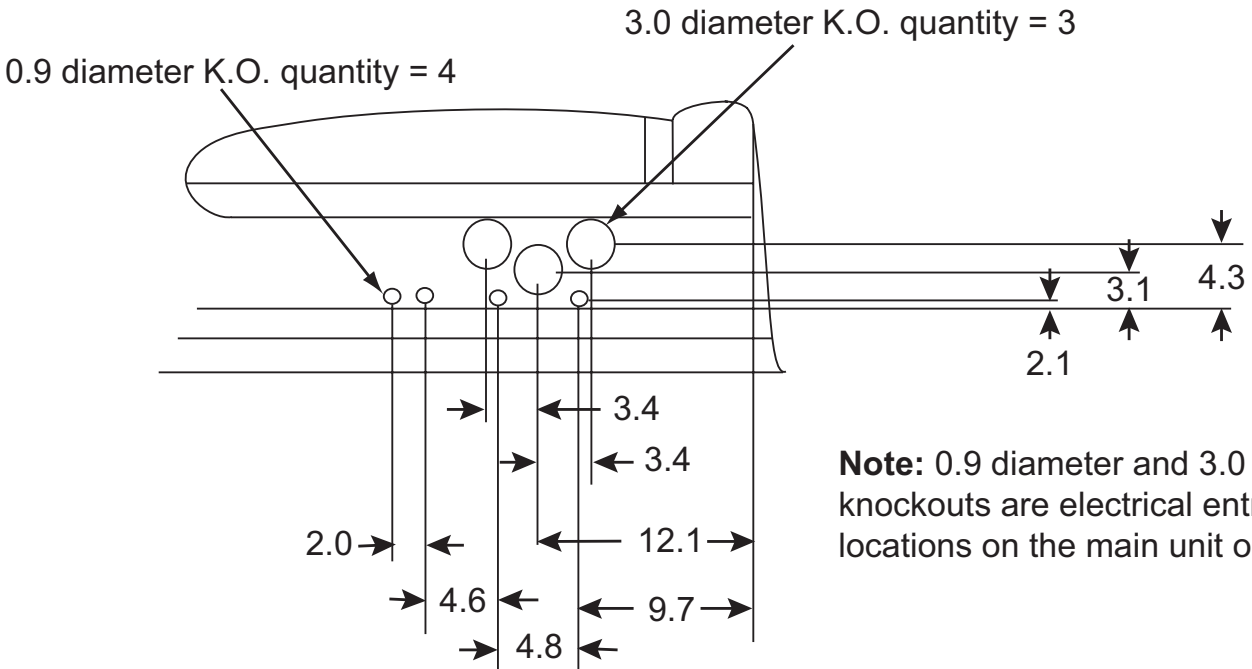
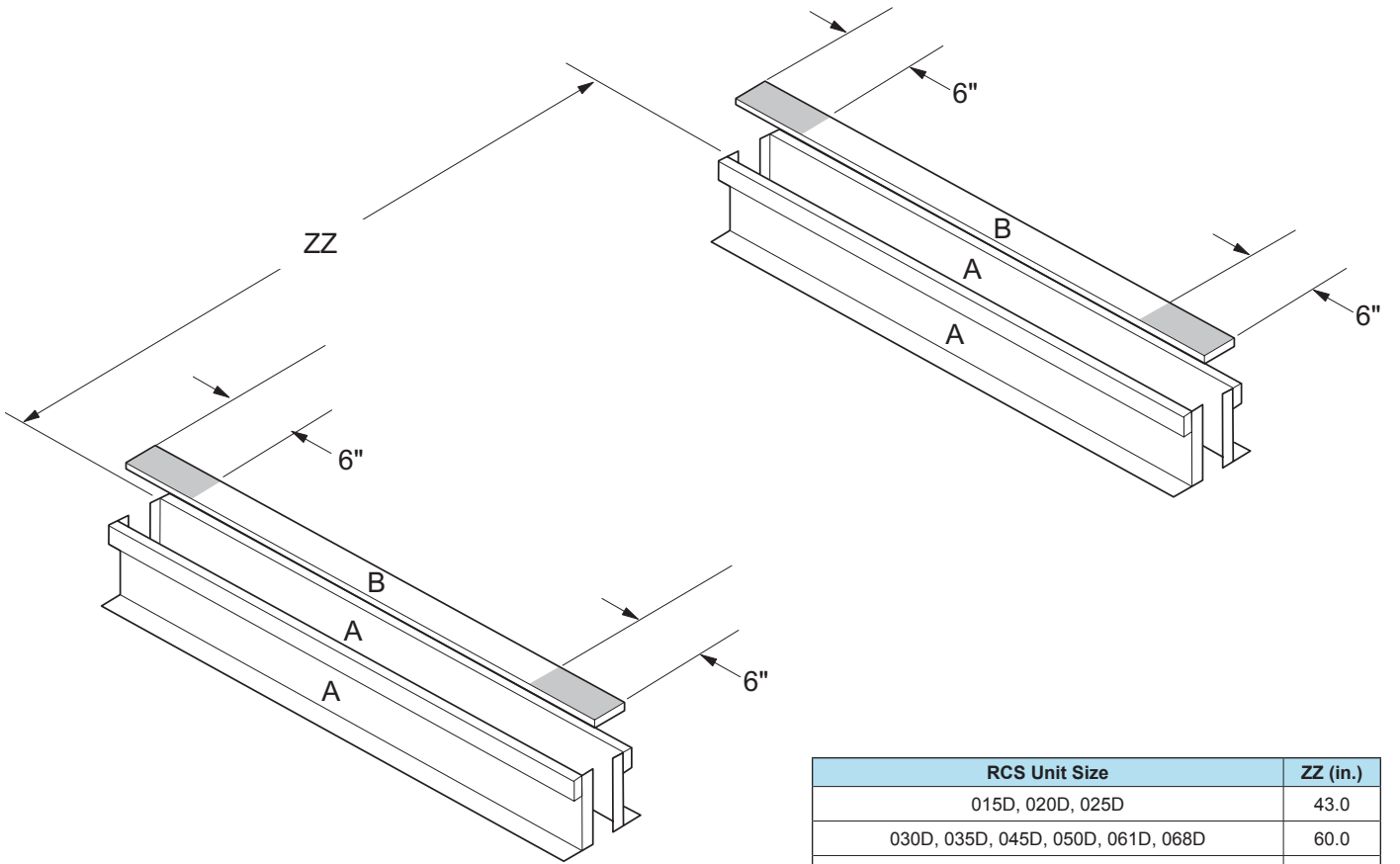

Figure 118: Knockout Detail, 045D to 140D



Note: 0.9 diameter and 3.0 diameter knockouts are electrical entrance locations on the main unit only.

Figure 119: RCS Roof Installation



RCS Unit Size	ZZ (in.)
015D, 020D, 025D	43.0
030D, 035D, 045D, 050D, 061D, 068D	60.0
016D, 021D, 026D, 031D, 042D, 051D, 063D, 070D, 071D, 075D, 079D, 080D, 085D, 090D, 100D, 105D	83.0
081D, 091D, 101D, 110D—140D	116.0

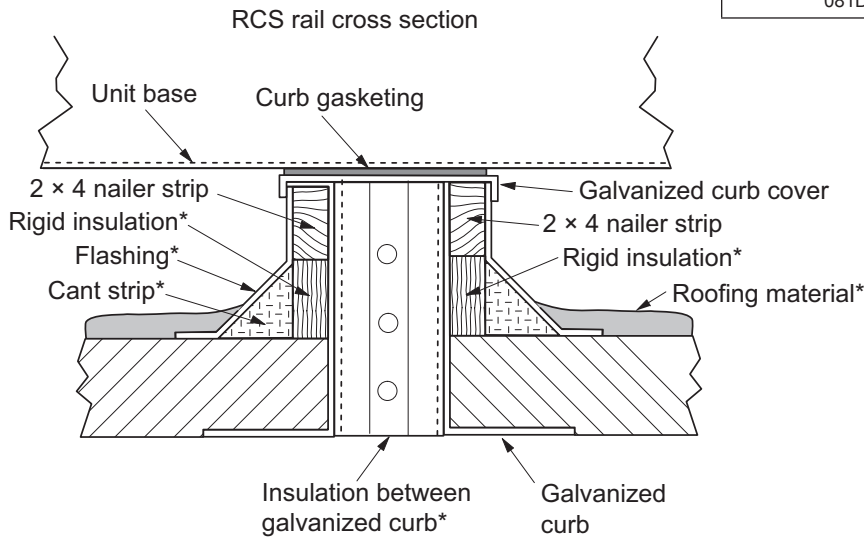

*Not furnished

Piping Connections, RFS/RCS Units

Figure 120: Refrigerant Piping Connection Locations Example

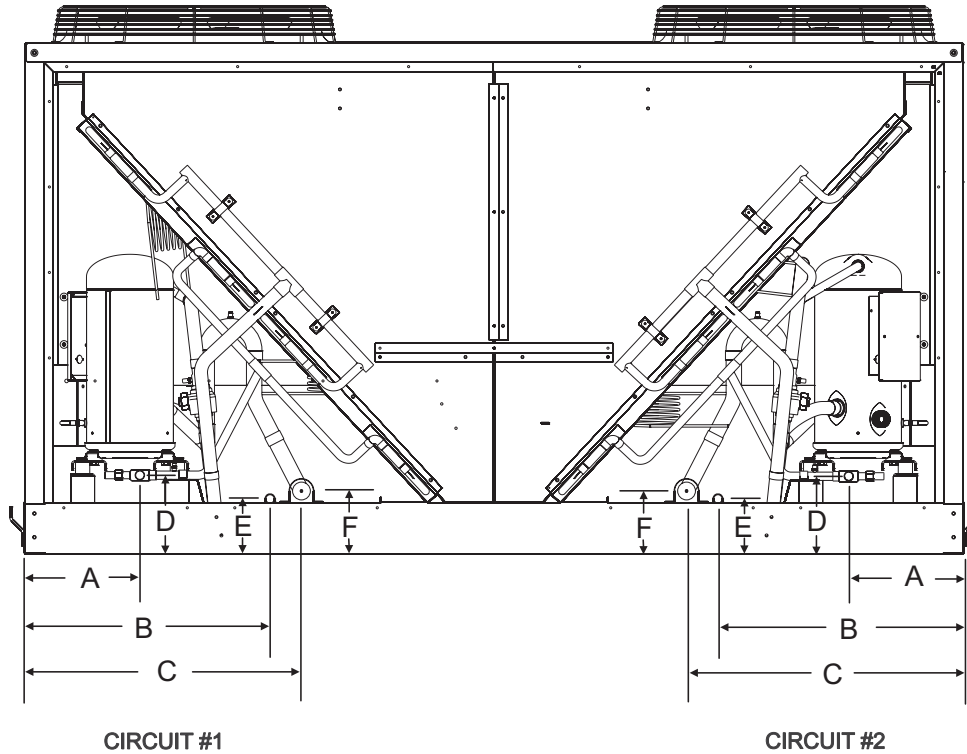

Table 34: 015D – 140D Connection Sizes and Locations

Dimension	Component	Circuit	Piping Dimension (inches)					
			015D–026D	030D–042D	045D–068D	070D–079D	080D–105D	110D–140D
A	Liquid Line #1 / #2	Circuit 1 & 2	16.7	12.9	12.0	13.5	11.2	20.8
B	HGBP Line #1 / #2	Circuit 1 & 2	24.0	25.4	25.9	25.9	28.1	25.9
C	Suction Line #1 / #2	Circuit 1 & 2	32.7	29.3	29.4	32.3	32.3	32.4
D	Liquid Line #1 / #2	Circuit 1 & 2	8.38	8.38	8.38	8.38	8.38	8.38
E	HGBP Line #1 / #2	Circuit 1 & 2	6.02	6.02	6.02	6.02	6.02	6.02
F	Suction Line #1 / #2	Circuit 1 & 2	6.62	6.62	6.62	6.62	6.62	6.62

Table 35: 015D – 140D Piping Diameter

Component	Circuit	Piping Diameter (inches)									
		015/016D	020/021D	025/026D	030/031D	035D	042D	045D	050/051D	061/063D	068D
Liquid Line #1 / #2	Circuit 1 & 2	5/8	5/8	7/8	7/8	7/8	7/8	7/8	7/8	7/8	7/8
HGBP Line #1 / #2	Circuit 1 & 2	7/8	7/8	7/8	7/8	7/8	7/8	7/8	7/8	7/8	7/8
Suction Line #1 / #2	Circuit 1 & 2	1-5/8	1-5/8	1-5/8	1-5/8	1-5/8	1-5/8	1-5/8	1-5/8	1-5/8	1-5/8
Component	Circuit	Piping Diameter (inches)									
		070/071D	075/079D	080/085D	090/091D	100/101D	105D	110D	120D	125D	130/140D
Liquid Line #1 / #2	Circuit 1 & 2	7/8	7/8	1-1/8	1-1/8	1-1/8	1-1/8	1-1/8	1-1/8	1-1/8	1-1/8
HGBP Line #1 / #2	Circuit 1 & 2	7/8	7/8	7/8	7/8	7/8	7/8	7/8	7/8	7/8	7/8
Suction Line #1 / #2	Circuit 1 & 2	2-5/8	2-5/8	2-5/8	2-5/8	2-5/8	2-5/8	2-5/8	2-5/8	2-5/8	2-5/8

Gas Piping Schematic

Figure 121: Gas Piping Schematic

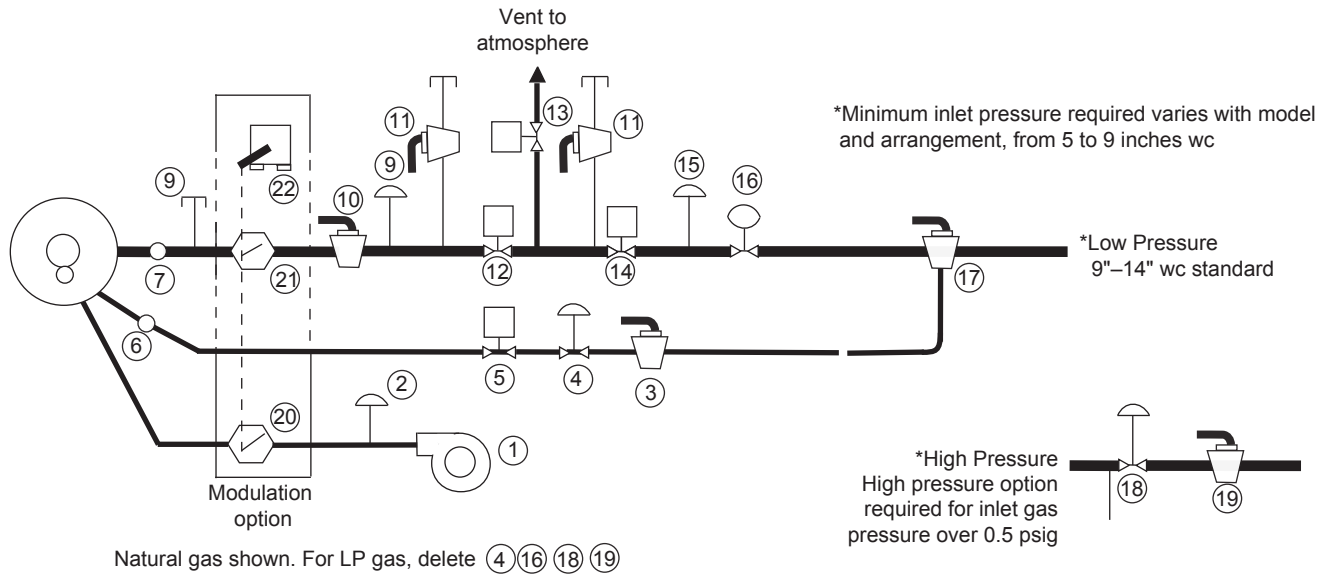

Item	Description	FM/ETL/UL		FM/ETL-C		IRI 400–2000 MBh
		Thru 400 MBh	Over 400 MBh	Thru 400 MBh	Over 400 MBh	
1	Forced draft blower	Standard	Standard	Standard	Standard	Standard
2	Combination air switch	Standard	Standard	Standard	Standard	Standard
3	Pilot cock	Standard	Standard	Standard	Standard	Standard
4	Pilot pressure regulator	Standard	Standard	Standard	Standard	Standard
5	Pilot gas valve	Standard	Standard	Standard	Standard	Standard
6	Pilot orifice	Standard	Standard	Standard	Standard	Standard
7	Main gas orifice	Standard	Standard	Standard	Standard	Standard
8	Manifold pressure tap	Standard	Standard	Standard	Standard	Standard
9	High pressure switch	—	—	—	Standard	—
10	Test cock	Standard	Standard	Standard	Standard	Standard
11	Leak test tap cock	—	—	—	—	Standard
12	Safety shutoff valve	Combination redundant valve and pressure regulator	Standard	Combination redundant valve and pressure regulator	—	Standard
13	Vent to atmosphere valve, N/O	—	—	—	—	Standard
14	Safety shutoff valve	Combination redundant valve and pressure regulator	Standard	Combination redundant valve and pressure regulator	Safety shut off valve	Safety shut off valve with proof of closure switch
15	Low pressure switch	—	—	—	—	Standard
16	Main pressure regulator	Combination redundant valve and pressure regulator	Standard	Combination redundant valve and pressure regulator	Standard	Standard
17	Main gas shutoff cock	Standard	Standard	Standard	Standard	Standard
18	High pressure regulator	Optional	Optional	Optional	Optional	Optional
19	Lubricated shutoff cock	Optional	Optional	Optional	Optional	Optional
20	Combustion air butterfly valve	Standard	Standard	Standard	Standard	Standard
21	Main gas butterfly valve	Standard	Standard	Standard	Standard	Standard
22	Modulating operator	Standard	Standard	Standard	Standard	Standard

Service Clearance

Allow recommended service clearances shown in [Figure 122](#). Provide a roof walkway along two sides of the unit for service and access to most controls.

Figure 122: Service Clearances

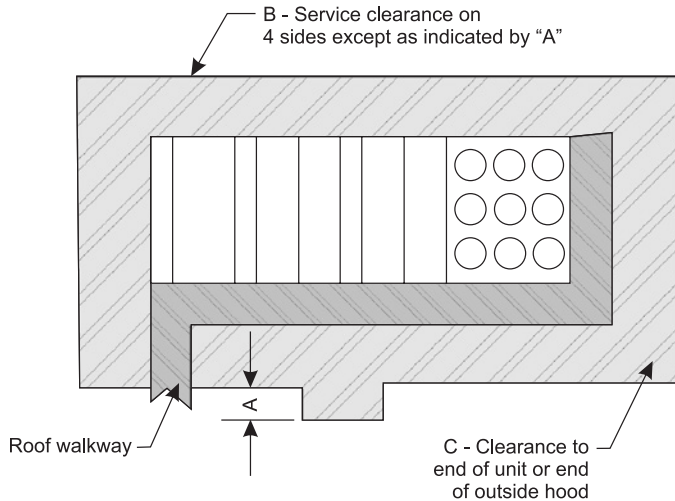

Cooling Coil, Heat and Supply Fan Service Clearance

Additional clearance, A, is recommended adjacent to the cooling coil, heat, and supply fan sections. See [Figure 82 on page 72](#) through [Figure 90 on page 80](#) to identify these sections.

Table 36: Service Clearance

Unit Size	A	B	C*
015D to 042D	30	60	60
045D to 140D	24	72	72

* Condenser coil placement is simplified if the following temporary access clearances can be arranged: 030D - 062D = 83", 070D - 100D = 106"

Figure 123: Ventilation Clearances

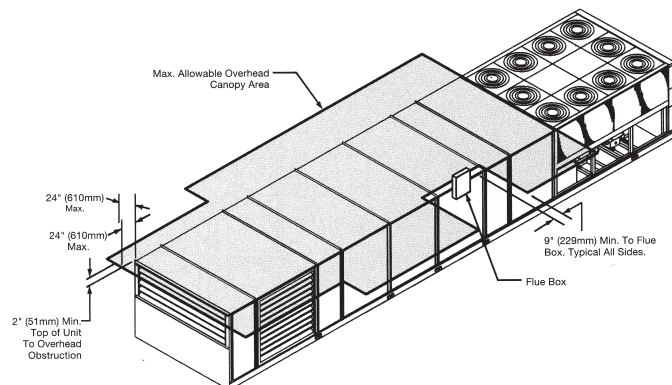

Overhead Clearance

- Unit(s) surrounded by screens or solid walls must have no overhead obstructions over any part of the unit.
- Area above condenser must be unobstructed in all installations to allow vertical air discharge.
- For overhead obstructions above the air handler section, observe the following restrictions:
 - No overhead obstructions above the furnace flue, or within 9 in. of the flue box.
 - Any overhead obstruction not within 2 in. of the top of the unit.
 - Service canopy not to protrude more than 24 in. beyond the unit in the area of the outside air and exhaust dampers.

Ventilation Clearance

Unit(s) surrounded by a screen or a fence:

- The bottom of the screen should be a minimum of 1 ft. above the roof surface.
- Minimum distance, unit to screen—same as service clearance ([Table 36](#)).
- Minimum distance, unit to unit—120 in.

Unit(s) surrounded by solid walls:

- Minimum distance, unit to wall—96 in., all sizes.
- Minimum distance, unit to unit—120 in.
- Wall height restrictions:
 - Wall on one side only or on two adjacent side—no restrictions.
 - Walls on more than two adjacent sides—wall height not to exceed unit height.

Do not locate outside air intakes near exhaust vents or other sources of contaminated air.

If the unit is installed where windy conditions are common, install wind screens around the unit, maintaining the clearances specified above. This is particularly important to prevent blowing snow from entering outside air intakes and to maintain adequate head pressure control when mechanical cooling is required at low outdoor air temperatures. SpeedTrol, required for compressor operation below 45°F, maintains proper head pressure in calm wind conditions.

Table 37: RPS/RFS/RCS/RDT Rated Load Amps^a

Model	Voltage	Circuit 1		Circuit 2		Model	Voltage	Circuit 1		Circuit 2	
		RLA/Comp	Comp Qty	RLA/Comp	Comp Qty			RLA/Comp	Comp Qty	RLA/Comp	Comp Qty
015D	208-60-3	27.6	1	27.6	2	075D	208-60-3	53.2	3	53.2	3
	230-60-3	25		25			48.1				
	460-60-3	12.2		12.2			18.6				
	575-60-3	9.4		9.4			14.7				
020D	208-60-3	37.6	1	19.3	2	079D	208-60-3	53.2	3	56.7	3
	230-60-3	34		17.4			51.3				
	460-60-3	19.2		8.6			23.1				
	575-60-3	12.9		6.5			19.9				
021D	208-60-3	37.6	1	19.3	2	080D/081D	208-60-3	53.2	3	53.2	3
	230-60-3	34		17.4			48.1				
	460-60-3	19.2		8.6			18.6				
	575-60-3	12.9		6.5			14.7				
025D/026D	208-60-3	53.2	1	24.8	2	085D	208-60-3	56.7	3	56.7	3
	230-60-3	48.1		22.4			51.3				
	460-60-3	18.6		10.6			23.1				
	575-60-3	14.7		7.7			19.9				
030D	208-60-3	56.7	1	25.7	2	090D/091D	208-60-3	56.7	3	56.7	3
	230-60-3	51.3		23.2			51.3				
	460-60-3	23.1		11.2			23.1				
	575-60-3	19.9		8.2			19.9				
035D	208-60-3	31.6	2	31.6	2	100D/101D	208-60-3	56.7	3	61.7	3
	230-60-3	28.6		28.6			55.8				
	460-60-3	14.5		14.5			26.9				
	575-60-3	11.6		11.6			23.7				
042D	208-60-3	33.7	2	33.7	2	105D	208-60-3	61.7	3	61.7	3
	230-60-3	30.5		30.5			55.8				
	460-60-3	15.8		15.8			26.9				
	575-60-3	12.2		12.2			23.7				
045D	208-60-3	37.6	2	37.6	2	110D	208-60-3	61.7	3	61.7	3
	230-60-3	34		34			55.8				
	460-60-3	19.2		19.2			26.9				
	575-60-3	12.9		12.9			23.7				
050D/051D	208-60-3	53.2	2	53.2	2	120D	208-60-3	61.7	3	81.7	3
	230-60-3	48.1		48.1			73.9				
	460-60-3	18.6		18.6			34.8				
	575-60-3	14.7		14.7			24.6				
061D	208-60-3	56.7	2	56.7	2	125D	208-60-3	81.7	3	81.7	3
	230-60-3	51.3		51.3			73.9				
	460-60-3	23.1		23.1			34.8				
	575-60-3	19.9		19.9			24.6				
063D	208-60-3	56.7	2	56.7	2	130D	208-60-3	81.7	3	81.7	3
	230-60-3	51.3		51.3			73.9				
	460-60-3	23.1		23.1			34.8				
	575-60-3	19.9		19.9			24.6				
068D	208-60-3	61.7	2	61.7	2	140D	208-60-3	81.7	3	99.6	3
	230-60-3	55.8		55.8			90.1				
	460-60-3	26.9		26.9			45.1				
	575-60-3	23.7		23.7			34.7				
070D/071D	208-60-3	36.8	3	36.8	3						
	230-60-3	33.3		33.3							
	460-60-3	17.9		17.9							
	575-60-3	12.8		12.8							

a. VFD compressor units in RPS and RDT only
b. Compressor information for units with variable speed inverter compressor.

Table 38: Variable Speed Inverter Compressor Rated Load Amps

Model	Voltage	Circuit 1		Circuit 2	
		RLA/Comp	Comp Quantity	RLA/Comp	Comp Quantity
016D ^a	208-60-3	27.6	1	47.0	1
	230-60-3	25.0		42.5	
	460-60-3	12.2		22.9	
020D ^a	208-60-3	37.6	1	47.0	1
	230-60-3	34		42.5	
	460-60-3	19.2		22.9	
021D ^a	208-60-3	37.6	1	47.0	1
	230-60-3	34		42.5	
	460-60-3	19.2		22.9	
025D ^a	208-60-3	53.2	1	47.0	1
	230-60-3	48.1		42.5	
	460-60-3	18.6		22.9	
026D ^a	208-60-3	53.2	1	47.0	1
	230-60-3	48.1		42.5	
	460-60-3	18.6		22.9	
031D ^a	208-60-3	56.7	2	61.7	1
	230-60-3	51.3		55.8	
	460-60-3	23.1		30.1	
035D ^a	208-60-3	31.6	2	61.7	1
	230-60-3	28.6		55.8	
	460-60-3	14.5		30.1	
042D ^a	208-60-3	33.7	2	61.7	1
	230-60-3	30.5		55.8	
	460-60-3	15.8		30.1	
045D ^a	208-60-3	37.6	2	76.1	1
	230-60-3	34		68.8	
	460-60-3	19.2		37.2	
050D ^a	208-60-3	53.2	2	81.4	1
	230-60-3	48.1		73.6	
	460-60-3	18.6		39.7	
051D ^a	208-60-3	53.2	2	86.8	1
	230-60-3	48.1		78.5	
	460-60-3	18.6		42.5	
063D ^a	208-60-3	56.7	2	92.5	1
	230-60-3	51.3		83.7	
	460-60-3	23.1		45.2	
074D ^a	208-60-3	56.7	2	92.5	1
	230-60-3	51.3		83.7	
	460-60-3	23.1		45.2	

a - Base unit with variable speed inverter compressor

Table 39: Condenser Fan Quantity

RPS/RCS Model	Quantity Fans
015D-026D	2
030D-051D	4
061D-071D, 080D-085D	6
075D, 079D, 090D, 091D, 105D, 110D	8
100D, 101D, 120D	9
125D	10
130D, 140D	12

Table 40: Condenser Fan Amps (each)

Voltage	Standard Fan		Quiet Fan	
	FLA	LRA	FLA	LRA
208	4.2	20.8	3.4	20.8
230	4.0	19.8	3.1	19.8
460	2.0	9.9	1.6	9.9
575	1.7	9.6	1.2	9.6

Table 41: Supply, Exhaust and Return Fan Motors, RPS/RFS/RDT 015D to 140D

Fan motor			208/60/3		230/60/3		460/60/3 ^a		575/60/3	
HP	Efficiency		FLA	LRA	FLA	LRA	FLA	LRA	FLA	LRA
1	High	ODP	3.9	26	2.8	20	1.4	10.5	1.15	9
	High	TEFC	4	27	2.8	21	1.4	10.5	1.2	9
	Premium	ODP	—	—	3	19.2	1.5	15	1.1	7.7
	Premium	TEFC	3.3	27	3	28	1.5	14	1.3	10
1.5	High	ODP	4.5	39	4.2	32	2.1	16	1.7	12.8
	High	TEFC	6.2	39	4.2	32	2.1	16	1.7	12.8
	Premium	ODP	4.8	40.3	4.2	25	2.1	14	1.7	14
	Premium	TEFC	—	—	4.2	40	2.1	20	1.7	16
2	High	ODP	7.1	47	5.6	42	2.8	21	2.2	16.8
	High	TEFC	7	50.6	5.6	48	2.8	24	2.2	17
	Premium	ODP	6.1	43.2	5.8	37.6	2.9	26.5	2.1	15
	Premium	TEFC	—	—	5.6	44	2.8	22	2.2	17
3	High	ODP	9.9	79	9	64.6	4.5	32.3	3.4	26.1
	High	TEFC	9.6	81	8.2	77.2	4.1	38.6	3.4	30.9
	Premium	ODP	9.3	74	8.2	64	4.1	32	3.1	25.6
	Premium	TEFC	9.4	80	8.2	71	4.1	35.5	3.3	29
5	High	ODP	16.1	106	14	94	7	47	5.3	38
	High	TEFC	15.2	126	13.4	102.4	6.7	51.2	5.4	39
	Premium	ODP	15.7	110	13.6	96	6.8	48	5.2	38.4
	Premium	TEFC	15	124	13	96	6.5	48	5.2	38
7.5	High	ODP	25	137	21.6	148.4	10.8	74.2	8.2	49
	High	TEFC	24.8	175.3	20.4	145.2	10.2	72.6	8.2	58
	Premium	ODP	22.3	185	20	122	10	80	7.4	52
	Premium	TEFC	22	177	20	141	10	70.5	8	56
10	High	ODP	33	290	28	180	14	94	11	72
	High	TEFC	29.5	228	28.4	200	14.2	100	11.4	80
	Premium	ODP	29	247	25.8	192	12.9	106	10.3	76.6
	Premium	TEFC	28.5	209	25	182	12.5	91	10	67
15	High	ODP	44.8	368	40.6	301	20.3	150.5	16.2	120
	High	TEFC	43.7	310	38.8	272	19.4	136	15.5	109
	Premium	ODP	43.4	271	37.8	233.6	18.9	117	14.1	94
	Premium	TEFC	42.4	282	37	246	18.5	123	14	89
20	High	ODP	61	342	50	350	25	175	20	135
	High	TEFC	60	465	48	320	24	160	19.1	123
	Premium	ODP	57	373	49	322	24.5	160.8	18.9	130
	Premium	TEFC	56	403	48	350	24	175	18.8	138
25	High	ODP	74	427	62	382	31	191	24.3	151
	High	TEFC	73	416	60	380	30	190	24.2	152
	Premium	ODP	70	438	61	380	30.5	190	24.2	125
	Premium	TEFC	68.4	431	61	376	30.5	188	22.8	148
30	High	ODP	86.5	560	75	460	37.5	230	30	177
	High	TEFC	87	448	72	460	36	230	28.6	184
	Premium	ODP	83.3	514	72.4	448	36.2	224	29.8	179
	Premium	TEFC	84	566	69	428	34.5	214	27.6	178
40	High	ODP	117	660	102	630	51	315	40	251
	High	TEFC	114	590	95	544	47.5	272	38	214
	Premium	ODP	110	730	96	630	48	315	38	245
	Premium	TEFC	106	734	94	650	47	325	37	213
50	High	ODP	140	832	124	770	62	385	49.2	303
	High	TEFC	136	840	118	744	59	372	48	266
	Premium	ODP	137	877	120	752	60	376	47.5	332
	Premium	TEFC	131	897	118	778	59	389	46	237
60	High	ODP	154	991	144	872	72	442	57.4	355
	High	TEFC	—	—	140	1022	70	511	56	409
	Premium	ODP	160	1125	140	912	70	456	56	345
	Premium	TEFC	—	—	140	1200	70	600	54	403
75	High	ODP	189	1240	176	1108	88	553	71	505
	High	TEFC	—	—	172	1132	86	566	68	447
	Premium	ODP	195	1240	170	1044	85	553	65.5	444
	Premium	TEFC	—	—	168	1186	84	593	66	504

a. For 380/50/3 applications, 460/60/3 motors are used. Derate nameplate by 0.85 to obtain actual horsepower.

Table 42: Electric Heat, RPS/RFS 015D to 042D

Model	208/60/3				240/60/3				480/60/3				600/60/3			
	kW	FLA	Steps	Stages ^b	kW	FLA	Steps ^a	Stages ^b	kW	FLA	Steps ^a	Stages ^b	kW	FLA	Steps ^a	Stages ^b
20	14.4	41.4	2	2	19.8	47.6	2	2	19.8	23.8	2	2	19.8	19.0	2	2
40	29.9	83.0	2	2	39.8	95.7	2	2	39.8	47.8	2	2	39.8	38.3	2	2
60	45.1	124.9	4	3	60.0	144.3	4	3	60.0	72.2	2	2	60.0	57.7	2	2
80	59.8	166.0	4	3	79.6	191.5	4	3	79.6	94.7	2	2	79.6	76.6	2	2
100	74.7	207.4	6	3	99.5	239.3	6	3	99.5	119.7	4	3	99.5	95.7	4	3
120	89.7	249.3	6	3	119.4	287.2	6	3	119.4	143.6	4	3	119.4	114.9	4	3
140	—	—	—	—	—	—	—	—	139.1	167.3	4	3	139.1	133.8	4	3
160	—	—	—	—	—	—	—	—	159.2	191.5	4	3	159.2	153.2	4	3
180	—	—	—	—	—	—	—	—	179.1	215.4	6	3	179.1	172.3	6	3
200	—	—	—	—	—	—	—	—	199.0	239.4	6	3	199.0	191.5	6	3
220	—	—	—	—	—	—	—	—	218.7	263.0	6	3	218.7	210.4	6	3
240	—	—	—	—	—	—	—	—	238.8	287.2	6	3	238.8	229.8	6	3

a. Number of fused circuits

b. Number of controlled heat stages from MicroTech III solid-state control system; additional fused circuits controlled by time delay relays.

See Table 15 on page 48 through Table 18 on page 49 for electric heat availability by unit size.*

Table 43: Electric Heat, RPS/RFS 045D to 140D

Model	208/60/3			240/60/3			480/60/3			600/60/3		
	kW	FLA	Stages	kW	FLA	Stages	kW	FLA	Stages	kW	FLA	Stages
40	29.9	83.0	2	39.8	95.7	2	39.8	47.9	2	39.8	38.3	2
60	45.1	124.9	2	60.0	144.3	2	60.0	72.2	2	60.0	57.7	2
80	59.8	166.0	4	79.6	191.5	4	79.6	95.7	4	79.6	76.6	4
100	74.7	207.4	4	99.5	239.4	4	99.5	119.7	4	99.5	95.7	4
120	89.7	249.3	4	119.4	287.2	4	119.4	143.6	4	119.4	114.9	4
160	119.7	332.0	4	159.2	383.0	4	159.2	191.5	4	159.2	153.2	4
—	—	—	—	—	—	—	199.0	239.4	4	199.0	191.5	4
—	—	—	—	—	—	—	238.8	287.2	6	238.8	229.8	6
—	—	—	—	—	—	—	278.6	335.1	4	278.6	268.1	4
—	—	—	—	—	—	—	318.4	383.0	4	318.4	306.4	4

See Table 19 on page 50 through Table 19 on page 50 for electric heat availability by unit size.

Supply Power Wiring

Table 44: RPS/RFS/RCS/RDT Recommended Power Wiring

Ampacity	Number of Power Wires per Phase	Number of Conduits	Wire Gauge	Insulation Rating (0°C)
30	1	1	10	60
40	1	1	8	60
55	1	1	6	60
70	1	1	4	60
85	1	1	3	60
95	1	1	2	60
130	1	1	1	75
150	1	1	1/0	75
175	1	1	2/0	75
200	1	1	3/0	75
230	1	1	4/0	75
255	1	1	250	75
285	1	1	300	75
310	1	1	350	75
335	1	1	400	75
380	1	1	500	75
400	2	2	3/0	75
460	2	2	4/0	75
510	2	2	250	75
570	2	2	300	75
620	2	2	350	75
670	2	2	400	75
760	2	2	500	75
765	3	3	250	75
855	3	3	300	75
930	3	3	350	75

1. Units require three-phase power supply.
2. Allowable voltage tolerances:
 - a. 60 Hertz
 - Nameplate 208V: Min. 187V, Max. 229V
 - Nameplate 230V: Min. 207V, Max. 253V
 - Nameplate 460V: Min. 414V, Max. 506V
 - Nameplate 575V: Min. 518V, Max. 633V
 - b. 50 Hertz
 - Nameplate 380V: Min. 360V, Max. 418V
3. Minimum Circuit Ampacity (MCA) Calculation:

NOTE: If a unit is provided with multiple power connections, each must be considered alone in selecting power wiring components.

The MCA is calculated based on the following formulas:

1. Units with cooling and all heating except electric heat
 $MCA = 1.25 \times \text{largest load} + \text{sum of all other loads}$
2. On units with electric heat, the MCA is computed both in the cooling mode and the heating mode and the greater of the two values is used.
 - a. Heating Mode
 - Electric heat less than or equal to 50 kW
 $MCA = 1.25 (\text{heater FLA} + \text{largest motor loads}) + (\text{the rest of the loads})$
 - Electric heat greater than or equal to 50 kW
 $MCA = 1.25 (\text{largest motor load}) + (\text{the rest of the loads}) + \text{heater FLA}$

NOTE: The compressor and condenser are not included in this heating mode calculation.

- b. Cooling Mode
 - $MCA = 1.25 \times \text{largest load} + \text{sum of all the other loads}$
3. Size wires in accordance with Table 310-16 or 310-19 of the National Electrical Code.
4. Wires should be sized for a maximum of 3% voltage drop.
5. There are two options for the convenience outlet and light circuit power connections.
 - a. Separate Field Power, 120 V, 15 amps minimum
 This option provides optimal service and maintenance flexibility. Control circuit ampacity need not be considered in MCA calculations.

NOTE: If the unit is provided with one or more fan section lights, they are powered from the separate 15 amp (minimum), 120V supply required by the NEC for the unit convenience outlet.

- b. Unit Powered – This option provides lowest installed cost. Control circuit ampacity must be added to unit ampacity if lights are ordered. Consult factory for details.

Table 45: RPS/RFS/RCS 015D to 040D (lbs)

Components	Unit Size					
	015/016D	020/021D	025/026D	030/031D	035D	042D/42D
Unit Configuration						
RPS basic unit	3762/4052	3852/4182	3862/4198	4264/4407	5308	5733
RFS basic unit ^a	2290	2290	2298		3126	3526
RCS basic unit	1499/1827	1613/1981	1848/2222	1899/2061	2548	3239
Unit Configuration – RPS Unit Model^f	016D^f	020D^f/021D^f	025D^f/026D^f	031D^f	035D^f	042D^f
RPS basic unit with Inverter Compressor	4204	4259	4302	4539	5317	5690
Outdoor/Return Air Options						
Return air plenum	Included in basic unit weight					
0%–30% O A hood with damper	145	145	145	145	145	145
100% O A hood with damper (deduct)	(338)	(338)	(338)	(338)	(449)	(449)
Economizer	515	515	515	515	637	637
Economizer with 30" RAF	637	637	637	637	637	637
Economizer with (2) 15" RAF	692	692	692	692	—	—
Economizer with 40" RAF	—	—	—	—	845	845
Blender (low cfm) ^f	540	540	540	540	540	540
Blender (high cfm) ^f	548	548	548	548	548	548
Filter Options—Draw-Through Section						
30% pleated	9	9	9	9	9	9
65% cartridge with prefilter	146	146	146	146	146	146
95% cartridge with prefilter	154	154	154	154	154	154
Filter Options—Blow-Through Section (Final Filters, 95% Cartridge)						
With cooling only, steam, or hot water heat	625	625	625	625	625	625
With gas or electric heat	794	794	794	794	794	794
Supply Air Fan Assembly						
(2) 15" x 6" diameter forward curved	345	345	345	345	—	—
(2) 15" x 15" diameter forward curved	375	375	375	375	—	—
20" diameter airfoil	556	556	556	556	—	—
24" diameter forward curved—LP	—	—	—	—	539	539
24" diameter forward curved—MP	—	—	—	—	569	569
24" diameter airfoil	—	—	—	—	574	574
Return Air Fan Assembly						
15" x 15" diameter forward curved	350	350	350	350	—	—
30" diameter airfoil	385	385	385	385	385	385
40" diameter airfoil	—	—	—	—	512	512
Evaporator Coils						
4-row, 10 Fpi	198	198	292	292	292	300
5-row, 10 Fpi	235	235	348	348	348	356
5-row, 12 Fpi	252	252	372	372	372	380
Hot Water Heat						
Low capacity	580	580	580	580	580	580
High capacity	630	630	630	630	630	630
Steam Heat						
Low capacity	575	575	575	575	575	575
High Capacity	605	605	605	605	605	605
Electric Heat						
20 kW	656	656	656	656	656	656
40 kW	664	664	664	664	664	664
60 kW	668	668	668	668	668	668
80 kW	696	696	696	696	696	696
100 kW	769	769	769	769	769	769
120 kW	777	777	777	777	777	777
140 kW	811	811	811	811	811	811
160 kW	819	819	819	819	819	819
180 kW	841	841	841	841	841	841
200 kW	849	849	849	849	849	849
Gas Furnace						
200, 250, 320, 400 MBh	964	964	964	964	964	964
500, 640 MBh	1041	1041	1041	1041	1041	1041
650, 790 MBh	1155	1155	1155	1155	1155	1155
800, 1000 MBh	1237	1237	1237	1237	1237	1237
Blank Section						
40", unlined	405	405	405	405	405	405
52", unlined	512	512	512	512	512	512
Accessory Items						
Variable frequency drive—SAF	150	150	150	150	150	150
Variable frequency drive RAF ^c	100	100	100	100	100	100
Insulation and Liners						
Weight per foot of unit length	24	24	24	24	24	24

a. Basic unit consists of return air plenum, angular filter section with 2" throwaway filters, supply fan section without fan or motor, cooling section without coil, discharge plenum, and condensing unit (RPS only) For RPS 015C to 30C and RPS 018C to 30C, cooling section is incorporated in the supply fan section

b. Final filter option includes liners in final filter and discharge plenum sections.

c. Does not include weight of blank section

d. Nominal 2", 1.5 lbs density solid liners, excluding condensing unit section and blank compartment

e. Does not include RAF and motor - must also include the weights listed below

f. Base unit with inverter compressor

Base Unit Weights

Table 46: Base Unit Weights (Less Options)

Unit Size	Unit Weight (lbs)				
	RCS	RFS	RDT	RPS	RPS ^a
045D/045D ^a	2455	3779	5420	6159	6226
050D/050D ^a , 051D ^a	2511/3315	3779	5469/6239	6215/6985	6336/7106
061D/063D ^a	2671/3441	3779	5581/6347	6342/7108	7207
068D	2575	3779	5592	6354	6354
070D/071D	3307/4000	3849	6297/7000	7156/7860	—
074D ^a	—	3849	6368	7236	8647
075D	3387	3849	6368	7236	7236
080D/081D	3603/4171	4682	6697/7266	8097/8666	8097/8666
085D	3615	4682	6716	8116	8116
090D/091D	3708/4278	4682	6816/7386	8216/8786	8216/8786
100D/101D	3764/4334	4974	7178/7738	8578/9158	8578/9158
105D	3726	4974	7147	8547	8547
110D	4277	4974	7706	9106	9106
120D	4858	5361	8687	10,087	10,087
125D	5439	5361	9275	10,675	10,675
130D	5532	5361	9275	10,675	10,675
140D	5619	5361	9476	10876	10876

a - Base unit with inverter compressor

Fan Motor Weights

Table 47: Supply, Exhaust and Return Fan Motors (All Size Units)

Motor HP	Weight (lbs)	
	Open Drip-Proof	Totally Enclosed
1	39	40
1.5	48	49
2	48	49
3	71	72
5	82	85
7.5	124	140
10	144	170
15	185	235
20	214	300
25	266	330
30	310	390
40	404	510
50	452	570
60	620	850
75	680	910

Option Weights

Table 48: RPS/RFS/RCS/RDT 050D to 140D (lbs)

Options	Unit Size		
	050D—079D	080D—091D	100D—140D
Outdoor/Return Air Options			
Return air plenum	Included in basic unit weight		
0%–30% O A hood	222	262	262
Economizer	1065	1266	1266
100% O A hood (deduct)	(139)	(71)	(71)
Blender Assembly			
Blender (low cfm) ^a	628	632	632
Blender (height cfm) ^a	632	731	731
Filter Options—Draw-Thru Section			
30% pleated	4	6	6
65% cartridge — std. flow	57	69	—
Med. flow	538	589	589
High flow	—	—	1100
95% cartridge — std. flow	67	83	—
Med. flow	550	605	605
High flow	—	—	1120
Filter Options—Blow-Thru Section (Final Filters)b			
95% cartridge — std. flow	1083	1296	—
Med. flow	1509	1760	1760
High flow	—	—	2275
Supply Air Fan Assembly			
27" diameter forward curved — LP	919	—	—
27" diameter forward curved — MP	942	—	—
27" diameter airfoil	868	—	—
30" diameter airfoil	965	—	—
33" diameter airfoil	—	989	—
36" diameter airfoil	—	1719	1719
40" diameter airfoil	—	—	1728
Return Air Fan Assembly			
40" diameter airfoil	629	—	—
44" diameter airfoil	—	971	971
Condenser Coil Options			
Copper fins	435	649	724
Coil guards	15	23	32
Evaporator Coils—Aluminum Fins, Standard Airflow Face Area			
3-row, 8 Fpi	370	487	792
3-row, 10 Fpi	395	520	830
3-row, 12 Fpi	419	553	867
4-row, 8 Fpi	445	588	905
4-row, 10 Fpi	478	632	955
4-row, 12 Fpi	510	676	1005
5-row, 8 Fpi	518	689	1022
5-row, 10 Fpi	559	744	1085
5-row, 12 Fpi	600	799	1147

a. Does not include the required 4' blank section weight

b. Final filter option includes liners in final filter and discharge plenum sectors.

Roof Curb Weights

Calculate the weight of the unit curb using one of the following equations and adding additional weights accordingly.

<u>Unit Size</u>	<u>Weight Formula</u>
050C-140C	Base curb wt. (lb.) = 0.74 [170 + 2 × curb length (in.)]

NOTE: Curb length does not include condenser length.

Additional Weights

- For blank compartment out of airstream, add 30 lbs.
- Cross supports:
 - For curb length greater than 144 in., add 30 lbs.
 - For curb length greater than 288 in., add 60 lbs.
 - For curb length greater than 432 in., add 90 lbs.
 - For curb length greater than 576 in., add 120 lbs.
- For condenser section support rail (RPS only), add 139 lbs.

Example: RPS 090D

<u>Component</u>	<u>Lbs</u>
Basic unit	8,216
Economizer	1,266
30% efficiency filters	6
Burglar bars, supply	69
Burglar bars, return	114
36" airfoil supply fan	1,719
44" airfoil return fan	971
DX coil—5-row 12 fpi, high airflow aluminum fins	1,528
Gas heat—1000 MBh	650
SAF motor—40 hp	404
RAF motor —15 hp	185
Curb length greater than 288	60
Liners	900
	16,088

<u>Liner calculations</u>	<u>ft</u>
Section	
Economizer	8
Filter	+ 2
Supply fan	+ 8
Heat	+ 4
DX coil	+ 4
Discharge plenum	+ 4
	<u> = 30</u>
	× 30 lbs.
	per ft.
	= 900 lbs

Example: RPS 090D

<u>Component</u>	<u>Lbs</u>
Basic unit	7,492
Economizer	1,266
30% efficiency filters	6
44" airfoil supply fan with VIV	1,437
44" airfoil return fan with VIV	1,122
DX coil—5-row 12 FPI, high airflow aluminum fins	1,528
SAF motor—40 hp	404
RAF motor —15 hp	185
Liners	600
	14,040 lbs

<u>Liner calculations</u>	<u>ft</u>
Section	
Economizer	8
Filter	2
Supply fan	8
Heat	4
DX coil	4
Discharge plenum	4
	<u> = 30</u>
	× 30 lbs. per ft
	= 600 lbs

NOTE: For structural purposes, consider roof curb weight.

Part 1: General

1 01 Section includes:

- A. Semi-custom packaged rooftop air conditioners.

1 02 References

- A. AFBMA 9—Load Ratings and Fatigue Life for Ball Bearings.
- B. AMCA 99—Standards Handbook.
- C. AMCA 210—Laboratory Methods of Testing Fans for Rating Purposes.
- D. AMCA 300—Test Code for Sound Rating Air Moving Devices.
- E. AMCA 500—Test Methods for Louver, Dampers, and Shutters.
- F. ANSI/AHRI—Standard 340/360—Large Unitary Equipment.
- G. NEMA MG1—Motors and Generators.
- H. NFPA 70—National Electrical Code.
 - I. SMACNA—HVAC Duct Construction Standards—Metal and Flexible.
- J. UL 900—Test Performance of Air Filter Units.

1 03 Submittals

- A. Shop Drawings: Indicate assembly, unit dimensions, weight loading, required clearances, construction details, field connection details, electrical characteristics and connection requirements. A computer generated psychometric chart shall be submitted for each cooling coil with design points and final operating point clearly noted.
- B. B. Product Data:
 - 1. Provide literature that indicates dimensions, weights, capacities, ratings, fan performance, gauges and finishes of materials, and electrical characteristics and connection requirements.
 - 2. Provide data on filter media, filter performance, filter assembly, and filter frames.
 - 3. Provide computer generated fan curves with specified operating point clearly plotted.
- C. Manufacturer's Installation Instructions.

1 04 Operation and Maintenance Data

- A. Maintenance Data: Provide instructions for installation, maintenance and service

1.05 Qualifications

- A. Manufacturer: Company specializing in manufacturing the Products specified in this section with minimum five years documented experience, who issues complete catalog data on total product.
- B. Startup must be done by trained personnel experienced with rooftop equipment.
- C. Do not operate units for any purpose, temporary or permanent, until ductwork is clean, filters and remote controls are in place, bearings lubricated, and manufacturers' installation instructions have been followed.

1 06 Delivery, Storage, and Handling

- A. Deliver, store, protect and handle products to site.
- B. Accept products on site in factory-fabricated protective containers, with factory-installed shipping skids. Inspect for damage.
- C. Store in clean dry place and protect from weather and construction traffic. Handle carefully to avoid damage to components, enclosures, and finish.

Part 2: Products

2 01 Manufacturers

- A. The following manufacturers will be considered provided they comply with contract documents. No substitutions will be permitted.
 - 1. Daikin
 - 2. Mammoth
 - 3. Engineered Air
 - 4. Seasons 4
 - 5. Energy Labs
 - 6. Gouvernaire

2 02 General Description

- A. Furnish as shown on plans, Daikin RoofPak™ Singlezone Heating and Cooling Unit(s) model [RPS] [RFS] [RCS] [RDT]. Unit performance and electrical characteristics shall be per the job schedule.
- B. Configuration: Fabricate as detailed on prints and drawings:
 1. Return fan/economizer section
 2. [Air blender]
 3. Filter section
 4. Blow-through supply fan section
 5. Heating coil section
 6. Access section
 7. Cooling coil section
 8. [Draw-through supply fan section]
 9. Diffuser
 10. [Sound attenuator]
 11. [Final filters]
 12. Discharge plenum
 13. Condensing unit section
- C. The complete unit shall be [ETL/MEA] [ETL-Canada] listed. The burner and gas train for the unit furnace shall be [IRI/FIA] approved.
- D. Each unit shall be specifically designed for outdoor rooftop application and include a weatherproof cabinet. Units shall be of a modular design with factory installed access sections available to provide maximum design flexibility. Each unit shall be [completely factory assembled and shipped in one piece] [split (045D–140D) at the condensing section] and/or [split between the supply fan section and the heat section]. Packaged units shall be shipped fully charged with Refrigerant R410A. RFS/RCS split systems and all units split between the evaporator and the condensing section are shipped with a nitrogen holding charge only.
- E. The unit shall undergo a complete factory run test prior to shipment. The factory test shall include final balancing of the supply [and return] fan assemblies, a refrigeration circuit run test, a unit control system operations checkout, [test and adjustment of the gas furnace], a unit refrigerant leak test and a final unit inspection.
- F. All units shall have decals and tags to indicate caution areas and aid unit service. Unit nameplates shall be fixed to the main control panel door. Electrical wiring diagrams shall be attached to the control panels. Installation, operating and maintenance bulletins and start-up forms shall be supplied with each unit.

- G. The Rooftop unit shall be designed, manufactured, and independently tested, rated, and certified to meet the seismic standards of the 2009 International Building Code and ASCE 7-06.
 1. Certificates of Compliance shall be provided with the quotation and include the manufacturer's identification, designation of certified characteristics, and the Independent Certifying Agency's name and report identification.
 2. Clear installation instructions shall be provided including all accessory components.
- H. Performance: All scheduled capacities and face areas are minimum accepted values. All scheduled amps, kW, and hp are maximum accepted values that allow scheduled capacity to be met. I. Warranty: The manufacturer shall provide 12-month parts only warranty. [The manufacturer will provide extended 48-month, parts only, warranty on the compressor.] Defective parts will be repaired or replaced during the warranty period at no charge. The warranty period shall commence at startup or six months after shipment, whichever occurs first.

2 03 Cabinet, Casing and Frame

- A. Standard double-wall construction for all side wall access doors and floor areas shall be provided with 22-gauge, solid galvanized steel inner liners to protect insulation during service and maintenance. Insulation shall be a minimum of 1" thick, 3/4-lb. density neoprene-coated glass fiber. Unit cabinet shall be designed to operate at total static pressures up to [5.5 inches w.g. unit sizes 015-042D] [6.5 inches w.g. unit sizes 045–140D]. Insulation on ceiling and end panels shall be secured with adhesive and mechanical fasteners. [Heavy gauge solid galvanized steel liners shall be provided throughout, allowing no exposed insulation within the air stream. All cabinet insulation, except floor panels, shall be a nominal 2" thick, 1½-lb. density, R6.5, glass fiber.] [A combination of solid and perforated galvanized steel liners shall be provided throughout. Perforated liners to be used in the supply and return air plenums to provide improved sound attenuation. All cabinet insulation, except floor panels, shall be a nominal 2" thick, 1½-lb. density, R6.5, glass fiber.] All floor panels shall include [double wall construction and include a nominal 2" thick, 1½ lb. density, R6.5 glass fiber insulation.] [a minimum 1" thick, 3-lb. density, R4.2 glass fiber glass insulation.]

- B. Exterior surfaces shall be constructed of pre-painted galvanized steel for aesthetics and long term durability. Paint finish to include a base primer with a high quality, polyester resin topcoat of a neutral beige color. Finished surface to withstand a minimum 1000-Hour salt spray test in accordance with ASTM B117 standard for salt spray resistance. Service doors shall be provided on both sides of each section in order to provide user access to all unit components. Service doors shall be constructed of heavy gauge galvanized steel with a gauge, galvanized steel interior liner. All service doors shall be mounted on multiple, stainless steel hinges and shall be secured by a latch system that is operated by a single, flush-mounted handle. The latch system shall feature a staggered engagement for ease of operation. Removable panels, or doors secured by multiple, mechanical fasteners are not acceptable.
- C. The unit base frame shall be constructed of [15-gauge (015D–040D)] [13-gauge (045D–140D)] pre-painted galvanized steel. The unit base shall overhang the roof curb for positive water runoff and shall have a formed recess that seats on the roof curb gasket to provide a positive, weathertight seal. Lifting brackets shall be provided on the unit base with lifting holes to accept cable or chain hooks.
- C. Airfoil supply fans
1. RPS and RFS supply fans shall be double width, double inlet (DWDI) airfoil centrifugal fan. All fans shall be mounted using shafts and hubs with mating keyways. Fans shall be Class II type and fabricated from heavy-gauge aluminum. Fan blades shall be continuously welded to the back plate and end rim.
 2. RDT supply fan shall be single width, single inlet (SWSI) airfoil centrifugal fan. The fan wheel shall be Class II construction with aluminum fan blades continuously welded to the back plate and end rim. Fans shall be mounted using shafts and hubs with mating keyways.
- D. Forward curved supply fans
- RPS and RFS supply fan shall be double width, double inlet forward curved centrifugal fan. All fans shall be mounted using shafts and hubs with mating keyways. The forward curved fan wheel and housing shall be fabricated from galvanized steel and shall be [Class I] [Class II] construction to satisfy the specified application.
- E. Airfoil return fans
- A single width, single inlet (SWSI) airfoil centrifugal return air fan shall be provided. The fan wheel shall be Class II construction and fabricated from heavy-gauge aluminum with fan blades continuously welded to the back plate and end rim. The fan shall be mounted using shafts and hubs with mating keyways. Exhaust fans are not acceptable.

2 04 Supply and Return Fans

- A. All fan assemblies shall be statically and dynamically balanced at the factory, including a final trim balance, prior to shipment. All fan assemblies shall employ solid steel fan shafts. Heavy-duty pillow block type, self-aligning, grease-lubricated ball bearings shall be used. Bearings shall be sized to provide an L-50 life at 200,000 hours. The entire fan assembly shall be isolated from the fan bulkhead and mounted on [rubber-in-shear isolators] [spring isolators] [spring isolators with seismic restraints]. [Fixed] [Adjustable] pitch V-belt drives with matching belts shall be provided. V-belt drives shall be selected at [the manufacturer's standard service factor] [1.5 times fan brake horsepower].
- B. Fan motors shall be heavy-duty 1800 rpm [open drip-proof (ODP)] [totally enclosed TEFC] type with grease-lubricated ball bearings. [Motors shall be high efficiency and meet applicable EPACT requirements.] [Motors shall be premium efficiency.] Motors shall be mounted on an adjustable base that provides for proper alignment and belt tension adjustment.
- F. Forward curved return fans
- Double width, double inlet (DWDI) forward curved centrifugal return air fans shall be provided. Fans shall be mounted using shafts and hubs with mating keyways. The fan wheels and housings shall be fabricated from painted steel and shall be Class I construction to satisfy the specified application. Exhaust fans are not acceptable.
- G. [The supply air fan and return air fan sections shall be provided with an expanded metal belt guard.]

2 05 Propeller Exhaust Fans (No Energy Recovery Wheel)

- A. Belt drive propeller exhaust fans shall be provided. Propellers shall be constructed with fabricated steel, and shall be securely attached to fan shafts. All propellers shall be statically and dynamically balanced. Motors shall be permanently lubricated, heavy-duty type, carefully matched to the fan load. Ground and polished steel fan shafts shall be mounted in permanently lubricated, sealed ball bearing pillow blocks. Bearings shall be selected for a minimum (L10) life in excess of 100,000 hours at maximum cataloged operating speeds. Drives shall be sized for a minimum of 105 percent of driven horsepower. Pulleys shall be of the fully machined cast iron type, keyed and securely attached to wheel and motor shafts. Motor sheaves shall be adjustable for system balancing. Drive frame and panel assemblies shall be galvanized steel. Drive frames shall be formed channels and panels shall be welded construction. The axial exhaust fans shall bear the AMCA Certified Ratings Seals for both sound and air performance. Return fans are not acceptable.
- B. The exhaust fans shall be controlled by a variable frequency drive.
- C. [The exhaust air fan sections shall be provided with an expanded metal belt guard.]

2 06 Variable Air Volume Control

- A. An electronic variable frequency drive shall be provided for the supply [and return] air fan. [Two independent drives, one per fan, shall be provided.] Each drive shall be factory installed downstream of the filters in a manner that the drive(s) are directly cooled by the filtered, mixed air stream. Drives shall meet UL Standard 95-5V and the variable frequency drive manufacturer shall have specifically approved them for plenum duty application. The completed unit assembly shall be listed by a recognized safety agency, such as ETL. Drives are to be accessible through a hinged door assembly complete with a single handle latch mechanism. Mounting arrangements that expose drives to high temperature, unfiltered ambient air is not acceptable.
- B. The unit manufacturer shall install all power/control wiring. [A manual bypass contactor arrangement shall be provided. The arrangement will allow fan operation at full design cfm, even if the drive has been removed for service]. [Line reactors shall be factory installed for each drive].

- C. The supply air fan drive output shall be controlled by the factory installed main unit control system and drive status and operating speed shall be monitored and displayed at the main unit control panel. [The supply and return/exhaust fan drive outputs shall be independently controlled in order to provide the control needed to maintain building pressure control. Supply and return/exhaust air fan drives that are slaved off of a common control output are not acceptable.]
- D. All drives shall be factory run tested prior to unit shipment.

2 06 Electrical

- A. Unit wiring shall comply with NEC requirements and with all applicable UL standards. All electrical components shall be UL recognized where applicable. All wiring and electrical components provided with unit shall be numbered and color-coded and labeled according to the electrical diagram provided for easy identification. The unit shall be provided with a factory wired weatherproof control panel. Unit shall have a [single] [dual] point power terminal block for main power connection. A terminal board shall be provided for low voltage control wiring. Branch short circuit protection, 115volt control circuit transformer and fuse, system switches, high temperature sensor, and a 115-volt receptacle with a separate electrical connection shall also be provided with unit.
- B. Each compressor and condenser fan motor shall be furnished with contactors, current sensing manual motor and short circuit protection, and inherent thermal overload protection. Supply and return fan motors shall have [contactors and external overload protection without VFDs] [Circuit breakers and built in overload protection with VFDs]. Knockouts shall be provided in the bottom of the main control panels for field wiring entrance. All 115–600 voltage wire shall be protected from damage by raceways or conduit.
- C. [A factory installed and wired marine service light, with switch and receptacle, shall be provided in the supply air and return/exhaust fan section. The separate, main unit service receptacle electrical circuit shall also power the light circuit.]
- D. [A factory installed and wired 115 volt power supply shall be provided for the GFI receptacle. The power supply shall be wired to the line side of the disconnect so the receptacle is powered when the main unit disconnect is off. This option shall include a weather proof transformer and disconnect for the 115 volt GFI. The 115 volt GFI electrical circuit shall complete with primary fused short circuit protection.]
- E. [Phase failure and under voltage protection on three-phase motors shall be provided to prevent damage from single phasing, phase reversal, and low voltage conditions.]
- F. [Ground fault protection shall be provided to protect against arcing ground faults.]

G. Further options

1. Factory-mounted smoke detectors shall be factory installed in the [supply air opening] [supply and return air openings]. Smoke detectors to be ionization type, which responds to invisible products of combustion without requiring the sensing of heat, flame or visible smoke. Upon sensing smoke, the unit shall provide a control output for use by building management system.
2. Unit to have factory-mounted UV lights located on the leaving air side of the cooling coil. Unit to have view port to allow for visual indication of operation through UV resistant glass. Unit to have door interlocks on each door accessing UV light. Interlock to kill power to UV light when door is opened.

Lamp and fixture to consist of a housing, power source, lamp sockets, and lamp. All components are to be constructed to withstand typical HVAC environments and are UL/C-UL listed. Housings are to be constructed of type 304 stainless steel and are to be equipped with both male and female power plugs with one type at each end to facilitate simple fixture-to-fixture plug-in for AC power.

Power source shall be an electric, rapid-type with overload protections and is to be designed to maximize radiance and reliability at UL/C-UL listed temperatures of 55°F–135°F. Power source will include RF and EMI suppression.

Sockets shall be medium bi-pin, single click safety, twist lock type and are to be constructed of a UVC-resistant polycarbonate.

Lamp shall be a high output, hot cathode, T8 diameter, medium bi-pin that produces UVGI of 254 nm. Each tube produces the specified output at 500 fpm and air temperatures of 55°F–135°F.

3. A [single] [dual] non-fused disconnect switch[es] shall be provided for disconnecting electrical power at the unit. [The second switch will service the condensing section.] Disconnect switches shall be mounted internally to the control panel and operated by an externally-mounted handle. Externally-mounted handle is designed to prohibit opening of the control panel door without the use of a service tool.

2 07 Heating and Cooling Sections

Cooling

- A. [The cooling coil section shall be installed in a blow-through configuration, downstream of the supply air fan. A factory-tested diffuser shall be used in order to provide air distribution across the cooling coil. A blow-through coil is specified to minimize the impact of fan motor heat.] [The cooling coil section shall be installed in a draw through configuration, upstream of the supply air fan.] The coil section shall be complete with factory piped cooling coil and sloped drain pan. Hinged access doors on both sides of the section shall provide convenient access to the cooling coil and drain pan for inspection and cleaning.

Submittals must demonstrate that scheduled unit leaving air temperature (LAT) is met, that fan and motor heat temperature rise (TR) have been considered, and scheduled entering air temperature (EAT) equals mixed air temperature (MAT).

Draw-through cooling—Scheduled EAT equals cooling coil EAT and scheduled unit LAT equals cooling coil LAT plus TR.

Blow-through cooling—Cooling coil EAT equals scheduled EAT plus TR and scheduled unit LAT equals cooling coil LAT.

Direct expansion (DX) cooling coils shall be fabricated of seamless 1/2" diameter high efficiency copper tubing that is mechanically expanded into high efficiency [aluminum] [copper] plate fins. Coils shall be a multi-row, staggered tube design with a minimum of [3] [4] [5] rows and a maximum of [8] [10] [12] fins per inch. All units shall have two independent refrigerant circuits and shall use an interlaced coil circuiting that keeps the full coil face active at all load conditions.

All coils shall be factory leak tested with high pressure air under water.

- B. A [painted galvanized steel,] [stainless steel,] positively sloped drain pan shall be provided with the cooling coil. The drain pan shall extend beyond the leaving side of the coil and underneath the cooling coil connections. The drain pan shall have a minimum slope of 1/8" per foot to provide positive draining. The drain pan shall be connected to a threaded drain connection extending through the unit base. Units with stacked cooling coils shall be provided with a secondary drain pan piped to the primary drain pan.

Hot Water Heating Option

- C. [A factory installed three-way modulating control valve and spring return valve actuator shall provide control of the hot water coil. The valve actuator shall be controlled by the factory installed main unit control system] A [1] [2] row hot water heating coil shall be factory installed in the unit heat section. Coils shall be fabricated of seamless 5/8" diameter copper tubing that is mechanically expanded into high efficiency HI-F rippled and corrugated aluminum plate fins. All coil vents and drains shall be factory installed. [The hot water heat section shall be installed downstream (RFS/RPS) of the supply air fan. A factory-tested diffuser shall be used in order to provide air distribution across the coil.] [The hot water heat section shall be installed upstream (RDT) of the supply air fan.] Hinged access doors shall provide convenient access to the coil and valve for inspection and cleaning.
- [[Ethylene glycol] [propylene glycol] shall be added to the hot water circuit to protect against coil freeze-up.]
- [A factory installed, non-averaging type freeze-stat shall be factory installed to provide some protection against coil freeze-up.]
- Coils shall be factory leak tested with high pressure air under water.

Steam Heating Option

- D. A [1 row, 6 fin per inch] [1 row, 12 fin per inch] [2 row, 6 fin per inch] fin per inch steam heating coil shall be factory installed in the unit heat section. Coils shall be fabricated of seamless 5/8" diameter copper tubing that is mechanically expanded into high efficiency HI-F rippled and corrugated aluminum plate fins. Steam coils shall be of the jet distributing type. [The steam heat section shall be installed downstream (RFS/RPS) of the supply air fan. A factory-tested diffuser shall be used in order to provide air distribution across the coil.] [The steam heat section shall be installed upstream (RDT) of the supply air fan.] Hinged access doors shall provide convenient access to the coil and valve for inspection and cleaning.
- [A factory installed two-way modulating control valve and spring return valve actuator shall provide control of the steam coil. The valve actuator shall be controlled by the factory installed main unit control system]
- [A factory installed, non-averaging type freeze-stat shall be factory installed to provide some protection against coil freeze-up.]
- Coils shall be factory leak tested with high pressure air under water.

Gas Heating Option

- E. A natural gas fired furnace shall be installed in the unit heat section. The heat exchanger shall include a type 321 stainless steel cylindrical primary combustion chamber, a type 321 stainless steel header, type 321 stainless steel secondary tubes and type 321 stainless steel turbulators. Carbon and aluminized steel heat exchanger surfaces are not acceptable. The heat exchanger shall have a condensate drain. Clean out of the primary heat exchanger and secondary tubes shall be accomplished without removing casing panels or passing soot through the supply air passages. The furnace section shall be positioned downstream of the supply air fan.
- [The furnace will be supplied with a modulating forced draft burner. The burner shall be controlled for low fire start. The burner shall be capable of continuous modulation between 33% and 100% of rated capacity and shall operate efficiently at all firing rates.]
- [The furnace shall be supplied with a Daikin SuperMod™ forced draft burner capable of continuous modulation between 5% and 100% of rated capacity, without steps. The burner shall operate efficiently at all firing rates. The burner shall have proven open damper low-high-low pre-purge cycle, and proven low fire start. The combustion air control damper shall be in the closed position during the off cycle to reduce losses.]
- The burner shall be specifically designed to burn natural gas and shall include a microprocessor based flame safeguard control, combustion air proving switch, pre-purge timer and spark ignition. The gas train shall include redundant gas valves, [maximum 0.5psi pressure regulator] [2–3psi high pressure regulator] [5–10psi high pressure regulator], shutoff cock, pilot gas valve, pilot pressure regulator, and pilot cock. The burner shall be rated for operation and full modulation capability at inlet gas pressures down to [7.0. W.C. (models 200–650)] [8.0 in. W.C. (models 790, 800, 1100, 1400, 1500)] [9.0 in. W.C. (models 100 and 2000)].
- The gas burner shall be controlled by the factory installed main unit control system.
- The burner shall be fired, tested and adjusted at the factory. Final adjustments shall be made in the field at initial start-up by a qualified service technician to verify that installation and operation of the burner is according to specifications.

Electric Heating Option

- F. Staged electric heating coils shall be factory installed in the unit heat section. Heating coils shall be constructed of a low watt density, high nickel-chromium alloy resistance wire, mechanically stacked and heli-arc welded to corrosion resistant terminals. A corrosion resistant heavy gauge rack shall support the elements. Safety controls shall include automatic reset high limit control for each heater element with manual reset backup line break protection in each heater element branch circuit (Note: Manual reset not provided when ETL-Canada label is provided). Heating element branch circuits shall be individually fused to maximum of 48 Amps per NEC requirements. The electric heat section shall be positioned downstream of the supply air fan.

The electric heat elements shall be controlled by the factory installed main unit control system.

2 08 Filters

Draw-through Filters

- A. Unit shall be provided with a draw-through filter section. The filter section shall be supplied complete with the filter rack as an integral part of the unit. The draw-through filter section shall be provided with [panel] [cartridge] filters.
- B. 2" thick AmericanAirFilter [MERV 8, 30%] [MERV 13, 85%] efficient pleated panel filters shall be provided. Filters shall be frame mounted and shall slide into galvanized steel racks contained within the unit. Filters shall be installed in an angular arrangement to maximize filter area and minimize filter face velocity. Filters shall be accessible from both sides of the filter section.
- C. 12" deep [MERV 11, 60-65%] [MERV 14, 90-95%] efficient, UL Std. 900, Class 1, AmericanAirFilter cartridge filters shall be provided. 2" panel, 30% efficient pre-filters shall be included. Cartridge filters shall consist of filter media permanently attached to a metal frame and shall slide into a gasketed, extruded aluminum rack contained within the unit. The filter rack shall have secondary gasketed, hinged end panels to insure proper sealing. Filters shall be accessible from both sides of the filter section.
- D. [30% efficient pleated] [60-65% efficient cartridge] [90-95% efficient cartridge] filters shall be provided with INTERSEPT® antimicrobial treatment.

Final Filters Option

- E. Final Filters—Unit shall be provided with a final filter section downstream of the supply fan. Unit to have 40" of unit length between the fan discharge and the final filters to allow for proper air distribution. The final filter section shall be supplied complete with the filter rack as an integral part of the unit. The final filter section shall be provided with cartridge filters.
- F. 12" deep 90-95% efficient, UL Std. 900, Class 1, AmericanAirFilter cartridge filters shall be provided. [For units with gas or electric heat, AmericanAirFilter High Temperature cartridge filters rated for 500° F shall be used.] Cartridge filters shall consist of filter media permanently attached to a metal frame and shall slide into a gasketed, extruded aluminum rack contained within the unit. The filter rack shall have secondary gasketed, hinged end panels to insure proper sealing. Filters shall be accessible from both sides of the filter section.
- G. [Filters shall be provided with INTERSEPT antimicrobial treatment.]

2 09 Outdoor / Return Air Section

Return Air Plenum

- A. Unit shall be provided with a return air plenum for handling 100% re-circulated air. The 100% return air plenum shall allow return air to enter from the [bottom] [back] of the unit.

Return Air Plenum with 0 to 30% Outdoor Air Hood

- B. A return air plenum shall be provided with a 0 to 30% outdoor air hood. The hood shall allow outdoor air to enter at the back of the return air plenum. The outdoor air hood shall be factory installed and constructed from galvanized steel finished with the same durable paint finish as the main unit. The hood shall include a bird screen to prevent infiltration of foreign materials and a rain lip to drain water away from the entering air stream. The return air plenum shall allow return air to enter from the [bottom] [back] of the unit.
- C. Daikin UltraSeal low leak dampers shall be provided. Damper blades shall be fully gasketed and side sealed and arranged horizontally in the hood. Damper leakage shall be less than 1.5 cfm per ft² of damper area at 1" static pressure differential. Leakage rate to be tested in accordance with AMCA Standard 500. Damper blades shall be operated from multiple sets of linkages mounted on the leaving face of the dampers. [Control of the dampers shall be from a factory installed, two-position actuator.]

0%–100% Outdoor Air Economizer (no energy recovery)

- D. Unit shall be provided with an outdoor air economizer section. The 0 to 100% outside air economizer section shall include outdoor, return, and exhaust air dampers. Outdoor air shall enter from both sides of the economizer section through horizontal, louvered intake panels complete with rain lip and bird screen. The floor of the outdoor air intakes shall provide for water drainage. The economizer section shall allow return air to enter from the [bottom] [back] of the unit.

The outside and return air dampers shall be sized to handle 100% of the supply air volume. The dampers shall be opposed sets of parallel blades, arranged vertically to converge the return air and outdoor air streams in multiple, circular mixing patterns. Daikin UltraSeal low leak dampers shall be provided. Damper blades shall be fully gasketed and side sealed. Damper leakage shall be less than 1.5 cfm per ft² of damper area at 1" static pressure differential. Leakage rate to be tested in accordance with AMCA Standard 500. Damper blades shall be operated from multiple sets of linkages mounted on the leaving face of the dampers.

A barometric exhaust damper shall be provided to exhaust air out of the back of the unit. [An electric actuator shall provide positive closure of the exhaust damper.] A bird screen shall be provided to prevent infiltration of rain and foreign materials. Exhaust damper blades shall be lined with urethane gasketing on contact edges.

Control of the dampers shall be by a factory installed actuator. Damper actuator shall be of the modulating, spring return type. [An adjustable enthalpy control shall be provided to sense the dry-bulb temperature and relative humidity of the outdoor air stream to determine if outdoor air is suitable for "free" cooling.] [A comparative enthalpy control shall be provided to sense and compare enthalpy in both the outdoor and return air streams to determine if outdoor air is suitable for "free" cooling.] If outdoor air is suitable for "free" cooling, the outdoor air dampers shall modulate in response to the unit's temperature control system.

DesignFlow Minimum Ventilation Air Control Option

- E. Daikin DesignFlow precision ventilation control system shall be provided as an integral part of the 0–100% outdoor air economizer system. It shall directly measure the total mass volume of air flowing through the outdoor air intakes. The unit's control panel shall automatically adjust the outdoor damper position to maintain minimum outdoor air cfm. The airflow station shall be capable of accurately measuring minimum outdoor air volume within 5% to continuously satisfy the requirements of ASHRAE 62–1999. Third party verification of measurement accuracy shall be verified by a nationally recognized independent testing agency.

100% OA Hood Option

- F. Unit shall be provided with a 100% outdoor air hood. The 100% outdoor air hood shall allow outdoor air to enter from the back of the unit, at the draw-through filter section. The outdoor air hood shall be factory installed and constructed from galvanized steel finished with the same durable paint finish as the main unit. The hood shall include a bird screen to prevent infiltration of foreign materials and a rain lip to drain water away from the entering air stream.
- G. Daikin UltraSeal low leak dampers shall be provided. Damper blades shall be fully gasketed and side sealed and arranged vertically in the hood. Damper leakage shall be less than 1.5 cfm per ft² of damper area at 1" static pressure differential. Leakage rate to be tested in accordance with AMCA Standard 500. Damper blades shall be operated from multiple sets of linkages mounted on the leaving face of the dampers. [Control of the dampers shall be from a factory installed, two-position actuator.]

Energy Recovery Option

- H. Unit shall be provided with [a modulating outdoor air economizer section with] an ARI certified energy recovery wheel. [The economizer section shall include outdoor, return and return exhaust air control. Bypass dampers and damper actuators shall be included that automatically bypass outdoor air around the wheel during economizer operation.] Outdoor air shall enter at the back of the section through a factory-installed hood capable of handling 100% outdoor air. The outdoor air hood shall be factory installed and constructed from galvanized steel finished with the same prepainted finish as the main unit. The hood shall include a bird screen to prevent infiltration of foreign material and a rain lip to drain water away from the entering air stream. Return air shall enter through the bottom of the unit. The entire section shall be double-wall construction.

- I. The enthalpy wheel shall be constructed of corrugated synthetic fibrous media, with a desiccant intimately bound and uniformly and permanently dispersed throughout the matrix structure of the media. Rotors with desiccants coated, bonded, or synthesized onto the media are not acceptable due to delamination or erosion of the desiccant material. Media shall be synthetic to provide corrosion resistance and resistance against attack from laboratory chemicals present in pharmaceutical, hospital, etc. environments as well as attack from external outdoor air conditions. Coated aluminum is not acceptable. Face flatness of the wheel shall be maximized (± 0.032 in.) in order to minimize wear on inner seal surfaces and to minimize cross leakage. Rotor shall be constructed of alternating layers of flat and corrugated media. Wheel layers should be uniform in construction forming uniform aperture sizes for airflow. Wheel construction shall be fluted or formed honeycomb geometry so as to eliminate internal wheel bypass. Wheel layers that can be separated or spread apart by airflow are unacceptable due to the possibility of channeling, internal bypass or leakage, and performance degradation. The media shall be in accordance with NFPA or UL guidelines. The desiccant material shall be a molecular sieve, specifically a 4A or smaller molecular sieve to minimize cross contamination. The wheel frames shall consist of evenly spaced steel spokes, galvanized steel outer band and rigid center hub. The wheel construction should allow for post fabrication wheel alignment. The wheel seals shall be brush seals, neoprene bulb seals, or equivalent. Seals should be easily adjustable. Cassettes shall be fabricated of heavy duty reinforced galvanized steel. Cassettes shall have a built-in adjustable purge section minimizing cross contamination of supply air. Bearings shall be in board, zero maintenance, permanently sealed roller bearings, or alternatively, external flanged bearings. Drive systems shall consist of fractional horsepower A.C. drive motors with multilink drive belts. The wheel shall be tested in accordance with NFPA or UL guidelines and shall be UL recognized or equivalent. The wheel capacity, air pressure drop, and efficiency shall be ARI certified by ARI and its testing agencies. Alternative independent performance testing must be pre-approved to be accepted. [Wheel shall be provided with variable speed control for frost protection.]
- J. The wheel recovers energy from the factory-supplied return exhaust section and includes an SWSI airfoil fan and motor in accordance with construction already specified. Gravity relief dampers and foldout exhaust hood shall be provided. All necessary exhaust fan motors, branch short circuit protection, and wiring [and controls] shall be provided. Two-inch, 30% pleated filters shall be provided in both air inlets to protect the wheel from dust and dirt in both the outdoor and return/exhaust air paths. Dampers to be Daikin UltraSeal, low-leak type, and shall be provided on outdoor or return dampers. Damper blades shall be fully gasketed and side sealed and arranged horizontally in the hood. Damper leakage shall be less than 0.2% at 1.5 inches static pressure differential. Leakage rate to be tested in accordance with AMC Standard 500. Damper blades shall be operated from multiple sets of linkages mounted on the leaving face of the dampers.

2 11 Access Section Option

- A. Unit shall be provided with factory installed access sections located [upstream] [downstream] [upstream and downstream] of the supply air fan, as shown on the unit drawing. Access sections shall have hinged access doors on both sides of the section and shall have the same construction features as the rest of the unit.

Blank Compartment

- B. An insulated, blank compartment shall be provided. The section shall be located after the discharge plenum and will be out of the air stream. The section shall be complete with insulation, double wall construction [and a service light].

2 12 Static Air Mixer (Air Blender) Option

- A. A static air mixing device shall be factory installed between the outside/return air section and the filter section. The static air mixer shall be installed with proper upstream and downstream distances. The mixing device shall perform at face velocities from 500 fpm through 2500 fpm with no loss in mixing performance. The mixing device shall provide mixing and distribution of the outside and return air streams to minimize the threat of coil freeze-up during operation and to improve temperature control. Acceptable manufacturers are Blender Products or Kees.

2 13 Sound Attenuator Option

- A. A section shall be provided by the air handling unit manufacturer as an integral part of the unit to attenuate fan noise at the source. Variable range of splitter thickness and air passages provided to optimize acoustic performance and energy conservation. The attenuators shall have perforated double-wall construction and be located downstream of the supply fan. Hinged access doors shall be provided on both sides of the section and shall have the same construction as the rest of the unit. [Sound attenuator shall have Tedlar coating for moisture protection]. Combustion rating for the silencer acoustic fill shall not be greater than the following UL fire hazard classification:

Flame Spread 15
 Fuel Contributed 0
 Smoke Developed 0

Tested in accordance with UL Test Procedure 723.

- B. The attenuator rating shall be determined using the duct-to-reverberant room test method which provides for airflow in both directions through the attenuator in accordance with latest version of ASTM specification E-477. Insertion Loss Ratings (ILR) shall be:

Octave Band at Center Frequency (Hz)								
	63	125	250	500	1000	2000	4000	8000
ILR (no Tedlar)	7	9	22	28	29	29	18	12
ILR (Tedlar coating)	6	10	20	16	14	18	13	12

- C. Manufacturer shall provide certified test data on dynamic insertion loss, self-generated sound power levels, and aerodynamic performance for reverse and forward flow test conditions to the design professional in writing as least 10 days prior to the bid.

2 14 Discharge And Return Plenum Accessories

- A. A supply air discharge plenum shall be provided. [The plenum section shall be lined with a perforated acoustic liner to enhance sound attenuation.] The plenum section shall have a [bottom] [side] [front (RFS only)] discharge opening.
- B. A combination burglar bar/safety grate shall be provided in the [bottom return air opening] [bottom supply air opening] [bottom return and supply air openings]. Burglar bar/safety grate shall be made of 3/4" diameter ground and polished steel shaft welded to a galvanized steel frame.
- C. Isolation dampers shall be provided in the [bottom return air opening] [bottom supply air opening] [bottom return and supply air openings]. [A two-position actuator shall be provided to close the dampers when the fans are not running.]

2 15 Condensing Unit

- A. The condensing section shall be open on the sides and bottom to provide access and to allow airflow through the coils. Condenser coils shall be multi-row and fabricated from cast aluminum micro-channel coils. Each condenser coil shall be factory leak tested with high-pressure air under water. Coils are to be recessed so that the cabinet provides built in hail protection.
- B. Condenser fans shall be direct drive, propeller type designed for low tip speed and vertical air discharge. [Condenser fan rpm shall be 1140 rpm maximum. Fan blades shall be constructed of steel and riveted to a steel center hub. Condenser fan motors shall be heavy-duty, inherently protected, three-phase, non-reversing type with permanently lubricated ball bearing and integral rain shield][Special quiet condenser fans shall consist of seven aerodynamic, airfoil blades with serrated trailing edges and special blade tips to break up turbulence and noise. Compressor sound blankets shall also be provided.]
- C. Each circuit shall have fan cycling of at least one condenser fan to maintain positive head pressure. An ambient thermostat shall prevent the refrigeration system from operating below 45° F.
- D. Liquid tight conduit shall be provided on exposed condensing section wiring.

Fixed Speed Scroll Compressors

- E. Each unit shall have multiple, heavy-duty Copeland® scroll compressors. Each compressor shall be complete with crankcase heater, sight-glass, anti-slug protection, current sensing and motor temperature sensing, motor overload protection and a time delay to prevent short cycling and simultaneous starting of compressors following a power failure. Compressors shall be isolated with resilient rubber isolators to decrease noise transmission.

Variable Speed Inverter Compressors

- F. Each unit shall have a variable speed inverter compressor on one circuit and [(016 through 031) one compliant fixed speed scroll compressor] on others, [multiple compliant fixed speed scroll compressors]. All compressors shall be isolated with resilient rubber isolators to decrease noise transmission.

The lead compressor shall be driven by variable frequency drive to control compressor speed. The compressor speed shall dynamically vary to match the space load. Inverter driven compressor shall be able to modulate from 25 Hertz to a maximum of 100 Hz. The minimum unit capacity shall be [(size 16) –20%] [(size 021& 026–15%)] [(size 031–17%)] [(size 042) –13%] [(size 045& 051–16%)] [(size 063–14%)] [(size 074–11%)] of full load. The variable speed inverter compressor motor shall be a brushless permanent magnet type, to provide higher efficiency at all speeds. Oil injection system shall be provided to ensure optimal efficiencies. Gearotor oil pump shall be provided for exceptional bearing lubrication at all compressor speed. Oil Strainer shall be provided to control the risk of system debris in the oil injection circuit. Each variable speed inverter compressor shall be engineered with an appropriate sized VFD to control compressor motor speed and to provide compressor protection functions. Each variable speed compressor shall include a crankcase heater (done via a DC holding current through the motor windings or external, sight-glass, current sensing & motor temperature sensing, motor overload protection and a time delay to prevent short cycling and simultaneous starting of compressors following a power failure.

Each fixed speed compressor shall include crankcase heater, sight-glass, anti-slug protection, current sensing and motor temperature sensing, motor overload protection and a time delay to prevent short cycling and simultaneous starting of compressors following a power failure.

Refrigeration Controls for Fixed Speed Scroll Compressors

- G. Each unit shall have two independent refrigeration circuits. Each circuit shall be complete with low pressure control, filter-drier, liquid moisture indicator/ sight-glass, solenoid, thermal expansion valve, liquid line shutoff valve with charging port, discharge line shutoff valve, a manual reset high pressure safety switch and high pressure relief device. The thermal expansion valve shall be capable of modulation from 100% to 25% of its rated capacity. Sight-glasses shall be accessible for viewing without disrupting unit operation. Each circuit shall be dehydrated and leak tested.

Refrigeration Controls for Variable Speed Inverter Compressors

- H. Each unit shall have two independent refrigeration circuits. Each circuit shall be completed with low pressure control, filter-drier, liquid moisture indicator/ sight-glass, solenoid, thermal expansion valve, liquid line shutoff valve with charging port, discharge line shutoff valve, a manual reset high pressure safety switch and high pressure relief device. The thermal expansion valve shall be capable of modulation from [(100% to [(size 16) –20%] [(size 021& 026–15%)] [(size 031–17%)] [(size 042)–13%] [(size 045& 051–16%)] [(size 063–14%)] [(size 074–11%)] of its rated capacity. Sight-glasses shall be accessible for viewing without disrupting unit operation. Each circuit shall be dehydrated and leak tested.

Capacity Control for Fixed Speed Scroll Compressors

- I. Refrigeration capacity control shall be accomplished by staging of the unit's multiple compressors. To maintain desired temperature control, the unit shall have a minimum of [two (size 15)][four (size 20–68)] [six (size 70–140)] steps of capacity control.
- J. All compressor capacity control staging shall be controlled by the factory installed main unit control system.

Capacity Control for Variable Speed Inverter Compressors

- K. Refrigeration capacity control shall be accomplished by modulating & staging of the unit's multiple compressors. To maintain desired temperature control, the unit shall have one variable speed compressor plus a minimum of [one (sizes 16, 21, 25, 31)][two (sizes 42, 45, 51, 63)] [three (size 74)] steps of capacity control for fixed speed compressor(s). The unit shall modulate the inverter compressor speed and stage the fixed compressors to deliver the desired set point temperature with the minimum amount of energy.
- L. All compressor capacity control modulating & staging shall be controlled by the factory installed main unit control system.

Options for Fixed Speed Scroll Compressors

- M. Hot gas bypass control shall be factory installed on one [both] refrigerant circuits. Hot gas bypass control shall include a modulating hot gas bypass control valve, all associated piping and be automatically operated by the units microprocessor control.
- N. Modulating hot gas reheat shall be provided on the lead circuit complete with modulating valves, micro-channel refrigerant reheat coil, and dehumidification control. Controls shall maintain $\pm 0.5^{\circ}\text{F}$ control of the reheat coil leaving air temperature.
- O. A vandal protection screen shall be provided on the condensing section. It will be constructed from PVC coated, 12-gauge steel wire.

Options for Variable Speed Inverter Compressors

- P. Hot gas bypass control shall be factory installed only on the fixed compressor refrigerant circuits. Hot gas bypass control shall include a modulating hot gas bypass control valve and all associated piping and shall be automatically operated.
- Q. Modulating hot gas reheat shall be provided on the lead circuit complete with modulating valves, micro-channel refrigerant reheat coil, and dehumidification control. Controls shall maintain $\pm 0.5^{\circ}\text{F}$ control of the reheat coil leaving air temperature.
- R. A vandal protection screen shall be provided on the condensing section. It will be constructed from PVC coated, 12-gauge steel wire.

2 16 Roof Curb

- A. A prefabricated 12-gauge galvanized steel, mounting curb, designed and manufactured by the unit manufacturer, shall be provided for field assembly on the roof decking prior to unit shipment. The roof curb shall be a full perimeter type with complete perimeter support of the air handling section and rail support of the condensing section. Supply and return opening duct frames shall be provided as part of the curb structure allowing duct connections to be made directly to the curb prior to unit arrival. The curb shall be a minimum of 16" high and include a nominal 2" x 4" wood nailing strip. Gasket shall be provided for field mounting between the unit base and roof curb.

2 17 Controls

- A. Each unit shall be equipped with a complete MicroTech III microprocessor based control system. The unit control system shall include all required temperature and pressure sensors, input/output boards, main microprocessor and operator interface. The unit control system shall perform all unit control functions including scheduling, unit diagnostics and safeties. Control sequences shall include [constant air volume, zone temperature control (CAV-ZTC)] [constant air volume, discharge temperature control (CAV-DTC)] [variable air volume, cooling only discharge temperature control (VAV-DTC)] [variable air volume, cooling/modulating heating discharge temperature control (VAV-DTC)] [duct static pressure control], [supply/return air fan tracking control] and [building static pressure control. All boards shall be individually replaceable for ease of service. All microprocessors, boards, and sensors shall be factory mounted, wired and tested.

- B. The microprocessor shall be a stand-alone DDC controller not dependent on communications with any on-site or remote PC or master control panel. The microprocessor shall maintain existing set points and operate stand alone if the unit loses either direct connect or network communications. The microprocessor memory shall be protected from voltage fluctuations as well as any extended power failures. All factory and user set schedules and control points shall be maintained in nonvolatile memory. No settings shall be lost, even during extended power shutdowns.
- C. An optional [BACnet IP] [BACnet MS/TP] [LonWorks] communication module shall be provided for direct interface to the BAS network.
- D. All digital inputs and outputs shall be protected against damage from transients or wrong voltages. The status of each input and output can be read on the display. All field wiring shall be terminated at a separate, clearly marked terminal strip.
- E. The microprocessor memory shall be protected from all voltage fluctuations as well as any extended power failures. The microprocessor shall maintain existing set points and operate stand alone if the rooftop loses either direct connect or network communications.
- F. The microprocessor shall have a built-in time schedule. The schedule shall be programmable from the unit keypad interface. The schedule shall be maintained in nonvolatile memory to insure that it is not lost during a power failure. There shall be one start/stop per day and a separate holiday schedule. The controller shall accept up to ten holidays each with up to a 5-day duration. Each unit shall also have the ability to accept a time schedule via BAS network communications.
- G. If the unit is to be programmed with a night setback or setup function, an optional space sensor shall be provided. Space sensors shall be available to support field selectable features. Sensor options shall include:
 1. Zone sensor with tenant override switch.
 2. #1 above plus a heating and cooling set point adjustment. (CAV-ZTC only)
- H. The display character format shall be 22 characters x 5 lines. The character font shall be a 5 x 8 dot matrix. The display shall be a supertwist liquid crystal display (LCD) with black characters on yellow background providing high visibility. The display form shall be in plain English coded formats. Lookup tables are not acceptable
- I. Adjustments and readings shall be made through a push/pull navigational wheel. All control settings shall be password protected from changes by unauthorized personnel.

- J. [Both a unit-mounted and remote-mounted UI shall be provided. Up to eight units can be connected to a remote UI. Both the unit-mounted and remote-mounted UI are always operable. The control contractor is responsible for wiring between the unit and the remote UI. The maximum wiring distance to the remote UI is 700 meters. Optical isolation shall protect the main unit controller from remote UI wiring problems. The remote UI shall be provided with the same navigational wheel and keypad/display and have comparable functionality to the unit-mounted UI.]
- K. The display shall provide the following information as required by selected unit options:
1. Unit status showing number of stages or percent capacity for heating, cooling, and economizer
 2. Supply, return, outdoor, and space air temperature
 3. Duct and building static pressure; the control contractor is responsible for providing and installing sensing tubes
 4. Supply fan and return fan status and airflow verification
 5. Supply and return VFD speed
 6. Outside air damper position and economizer mode
 7. Cooling and heating changeover status
 8. Occupied, unoccupied, and dirty filter status
 9. Date and time schedules
 10. Up to ten current alarms and 25 previous alarms with time and date
- L. The push/pull navigation wheel shall allow the following set points as a minimum as required by selected unit options:
1. Six control modes including off manual, auto, heat/cool, cool only, heat only, and fan only
 2. Four occupancy modes including auto, occupied, unoccupied and bypass (tenant override with adjustable duration)
 3. Control changeover based on return air temperature, outdoor air temperature, or space temperature
 4. Primary cooling and heating set point temperature based on supply or space temperature
 5. Night setback and setup space temperature
 6. Cooling and heating control differential (or dead band)
 7. Cooling and heating supply temperature reset options based on one of the following: Return air temperature, outdoor air temperature, space temperature, airflow, or external (1–5 VDC) signal
 8. Reset schedule temperature
 9. High supply, low supply, and high return air temperature alarm limits
 10. Ambient compressor and heat lockout temperatures
 11. Compressor interstage timers duration
 12. Duct and building static pressure
 13. Return fan tracking (VaneTrol) settings that include minimum/maximum VFD speed
 14. Minimum outdoor airflow reset based on external reset (1–5 VFD) percent of cfm capacity, and fixed outdoor damper position
 15. Economizer changeover based on enthalpy, dry bulb or network signal
 16. Current time and date
 17. Occupied/unoccupied time schedules with allowances for holiday/event dates and duration
 18. Three types of service modes including timers normal (all time delays), timers fast (all time delays 20 seconds), and normal
 19. Tenant override time

- M. Open Communication Protocol—The unit control system shall have the ability to communicate to an independent Building Management System (BMS) through a direct [BACnet IP] [BACnet MS/TP] [LonWorks] communication connection. The independent BMS system shall have access to [quantity from specification] “read only” variables and [quantity from specification] “read & write” variables. Communications shall not require field mounting of any additional sensors or devices at the unit. [The communications protocol shall be LonMark 3.4 certified under the [Discharge Air] [Space Comfort] functional profiles.]
- The BMS system shall be capable of interacting with the individual rooftop controllers in the following ways:
1. Monitor controller inputs, outputs, set points, parameters and alarms
 2. Set controller set points and parameters
 3. Clear alarms
 4. Reset the cooling and heating discharge air temperature set point (VAV and CAV-DTC units)
 5. Reset the duct static pressure set point (VAV units)
 6. Set the heat/cool changeover temperature (VAV and CAV-DTC units)
 7. Set the representative zone temperature (CAVZTC units)
- N. It will be the responsibility of the Systems Integrating Contractor to integrate the rooftop data into the BMS control logic and interface stations.

Part 3: Execution

3 01 Installation

- A. Install in accordance with manufacturer's instructions.



Daikin Applied Training and Development

Now that you have made an investment in modern, efficient Daikin equipment, its care should be a high priority. For training information on all Daikin HVAC products, please visit us at www.DaikinApplied.com and click on Training, or call 540-248-9646 and ask for the Training Department.

Warranty

All Daikin equipment is sold pursuant to its standard terms and conditions of sale, including Limited Product Warranty. Consult your local Daikin Applied representative for warranty details. To find your local Daikin Applied representative, go to www.DaikinApplied.com.

Aftermarket Services

To find your local parts office, visit www.DaikinApplied.com or call 800-37PARTS (800-377-2787). To find your local service office, visit www.DaikinApplied.com or call 800-432-1342.

This document contains the most current product information as of this printing. For the most up-to-date product information, please go to www.DaikinApplied.com.

Products manufactured in an ISO Certified Facility.