



**ECOLOGIC™ Air-Cooled and Fluid Cooled Chillers**

# Controls, Start-Up, Operation, Service, and Troubleshooting

## SAFETY CONSIDERATIONS

Installing, starting up, and servicing this equipment can be hazardous due to system pressures, electrical components, and equipment location (roof, elevated structures, etc.). Only trained, qualified installers and service mechanics should install, start up, and service this equipment.

When working on this equipment, observe precautions in the literature, and on tags, stickers, and labels attached to the equipment, and any other safety precautions that apply. Follow all safety codes. Wear safety glasses and work gloves. Use care in handling, rigging, and setting this equipment, and in handling all electrical components.

### ⚠ WARNING

Electrical shock can cause personal injury and death. Shut off all power to this equipment during installation and service. There may be more than one disconnect switch. Tag all disconnect locations to alert others not to restore power until work is completed.

### ⚠ WARNING

This unit uses a microprocessor-based electronic control system. Do not use jumpers or other tools to short out components, or to bypass or otherwise depart from recommended procedures. Any short-to-ground of the control board or accompanying wiring may destroy the electronic modules or electrical components.

### ⚠ WARNING

To prevent potential damage to heat exchanger tubes always run fluid through heat exchangers when adding or removing refrigerant charge.

DO NOT VENT refrigerant relief valves within a building. Outlet from relief valves must be vented outdoors in accordance with the latest edition of ANSI/ASHRAE (American National Standards Institute/American Society of Heating, Refrigeration and Air Conditioning Engineers) 15 (Safety Code for Mechanical Refrigeration). The accumulation of refrigerant in an enclosed space can displace oxygen and cause asphyxiation. Provide adequate ventilation in enclosed or low overhead areas. Inhalation of high concentrations of vapor is harmful and may cause heart irregularities, unconsciousness or death. Misuse can be fatal. Vapor is heavier than air and reduces the amount of oxygen available for breathing. Product causes eye and skin irritation. Decomposition products are hazardous.

### ⚠ WARNING

DO NOT attempt to unbraid factory joints when servicing this equipment. Compressor oil is flammable and there is no way to detect how much oil may be in any of the refrigerant lines. Cut lines with a tubing cutter as required when performing service. Use a pan to catch any oil that may come out of the lines and as a gage for how much oil to add to system. DO NOT re-use compressor oil.

## CONTENTS

	Page
<b>SAFETY CONSIDERATIONS</b> .....	1
<b>GENERAL</b> .....	2
<b>MAJOR SYSTEM COMPONENTS</b> .....	3
Processor Module (PSIO-1) .....	3
DSIO-HV Relay Module .....	3
Electronic Expansion Device Module .....	3
Compressor Protection Module (CPM) .....	3
PSIO-2 (8052) Module .....	3
Keypad and Display Module (Also Called HSIO-II) .....	3
Control (LOR) Switch .....	3
<b>OPERATION DATA</b> .....	3-42
Electronic Expansion Device (EXD) .....	3
• EXV OPERATION	
• ECONOMIZER OPERATION	
Oil Pumps .....	4
Motor Cooling .....	4
Back Pressure Valve (30GX and 30HXA only) ..	4
Sensors .....	4
Compressor Protection Module (CPM) .....	4
• OUTPUTS	
• INPUTS	
Wye-Delta vs Across-the-Line (XL) Starting Option .....	5
Capacity Control .....	6
• MINUTES LEFT FOR START	
• MINUTES OFF TIME	
• LOADING SEQUENCE	
• CLOSE CONTROL	
• LEAD/LAG DETERMINATION	
• CAPACITY SEQUENCE DETERMINATION	
• MINIMUM LOAD VALVE	
• CAPACITY CONTROL OVERRIDES	
Head Pressure Control .....	8
• GENERAL	
• AIR COOLED UNITS (30GX)	
• WATER COOLED UNITS (30HX)	
• ADJUSTING PID ROUTINES	
Cooler and Condenser (30HXC) Pump Control .....	10

## CONTENTS (cont)

	Page
• COOLER PUMP CONTROL	
• CONDENSER PUMP CONTROL	
<b>Cooler Heater Control</b> .....	13
<b>Keypad and Display Module</b> (Also Called HSI0-II) .....	13
• ACCESSING FUNCTIONS AND SUBFUNCTIONS .....	13
• AUTOMATIC DEFAULT DISPLAY .....	13
• STATUS FUNCTION .....	16
• TEST FUNCTION .....	25
• HISTORY FUNCTION .....	25
• SET POINT FUNCTION .....	25
• SERVICE FUNCTION .....	30
• SCHEDULE FUNCTION .....	37
<b>Temperature Reset</b> .....	39
• EXTERNAL TEMPERATURE RESET	
• EXTERNALLY POWERED RESET	
• RETURN FLUID TEMPERATURE RESET	
<b>Demand Limit</b> .....	39
• DEMAND LIMIT	
• EXTERNALLY POWERED DEMAND LIMIT	
• DEMAND LIMIT (CCN Loadshed Controlled)	
<b>TROUBLESHOOTING</b> .....	43-52
<b>Checking Display Codes</b> .....	43
<b>Unit Shutoff</b> .....	43
<b>Complete Unit Stoppage</b> .....	43
<b>Single Circuit Stoppage</b> .....	43
<b>Restart Procedure</b> .....	43
• POWER FAILURE EXTERNAL TO THE UNIT	
<b>Alarms and Alerts</b> .....	43
<b>Compressor Alarm/Alert Circuit</b> .....	43
<b>EXD Troubleshooting Procedure</b> .....	50
• INSPECTING/OPENING ELECTRONIC EXPANSION VALVES	
• INSPECTING/OPENING ECONOMIZERS	
<b>SERVICE</b> .....	52-66
<b>Servicing Coolers and Condensers</b> .....	52
• TUBE PLUGGING	
• RETUBING	
• TIGHTENING COOLER/CONDENSER HEAD BOLTS	
<b>Inspecting/Cleaning Heat Exchangers</b> .....	53
• COOLERS	
• CONDENSERS (30HX Only)	
<b>Water Treatment</b> .....	53
<b>Condenser Coils (30GX Only)</b> .....	53
• COIL CLEANING	
<b>Condenser Fans (30GX Only)</b> .....	54
<b>Refrigerant Charging/Adding Charge</b> .....	54
<b>Oil Charging/Low Oil Recharging</b> .....	55
<b>Oil Filter Maintenance</b> .....	56
• REPLACING THE EXTERNAL OIL FILTER	
• REPLACING THE INTERNAL OIL FILTER	
<b>Compressor Changeout Sequence</b> .....	56
• BURNOUT CLEAN-UP PROCEDURE	
<b>Moisture-Liquid Indicator</b> .....	58
<b>Filter Drier</b> .....	58
<b>Liquid Line Service Valve</b> .....	58
<b>Thermistors</b> .....	58
• LOCATION	
• THERMISTOR REPLACEMENT	
<b>Pressure Transducers</b> .....	59
• PRESSURE TRANSDUCER CALIBRATION	
• TROUBLESHOOTING	
<b>Safety Devices</b> .....	62
• COMPRESSOR PROTECTION	
• OIL SEPARATOR HEATERS (30GX)	
• COOLER PROTECTION	

<b>Relief Devices</b> .....	62
• PRESSURE RELIEF VALVES	
<b>Control Modules</b> .....	64
• PROCESSOR MODULE (PSIO-1), HIGH VOLTAGE RELAY MODULE (DSIO-HV), AND EXV DRIVER MODULE (DSIO-EXV), 12/6 MODULE (PSIO-2)	
• RED LED	
• GREEN LED	
<b>Carrier Comfort Network (CCN) Interface</b> .....	64
• PROCESSOR MODULE (PSIO-1)	
• HIGH VOLTAGE RELAY MODULE (DSIO-HV)	
<b>Replacing Defective Processor Module</b> .....	66
<b>Winter Shutdown Preparation</b> .....	66
<b>PRE-START-UP PROCEDURE</b> .....	67
<b>START-UP AND OPERATION</b> .....	67
<b>FIELD WIRING</b> .....	68-73
<b>APPENDIX A</b> (Compressor Must Trip Amps) .....	74-76
<b>APPENDIX B</b> (Capacity Loading Sequence) .....	77-79
<b>APPENDIX C (Available Accessories)</b> .....	80
<b>APPENDIX D (CPM Configurations)</b> .....	81-85
<b>APPENDIX E (Cooler and Condenser Pressure Drop)</b> .....	86-88
<b>APPENDIX F</b> (Typical System Components) .....	89,90
<b>INDEX</b> .....	91
<b>START-UP CHECKLIST</b> .....	CL-1 to CL-8

## GENERAL

IMPORTANT: The 30GX/HX units use refrigerant R-134a. Compressor oil used with R-134a is Poly-lester oil.

This publication contains Start-Up, Service, Controls, Operation and Troubleshooting data for the 30GX080-265 and 30HXA,C076-271 screw chillers.

Circuits are identified as circuits A and B, and compressors are identified as A1 or A2 in circuit A, and B1 in circuit B.

The 30GX/HX Series chillers feature microprocessor-based electronic controls and electronic expansion devices (EXD) in each refrigeration circuit.

The control system cycles compressor loaders and/or compressors to maintain the selected leaving fluid temperature set point. The system automatically positions the EXD to maintain the specified refrigerant level in the cooler. The system also has capabilities to control a condenser water valve to maintain suitable leaving-water temperature for the 30HXC unit. Safeties are continuously monitored to prevent the unit from operating under unsafe conditions. A scheduling function can be programmed by the user to control the unit's occupied and unoccupied schedules. The control also operates a test function and a manual control function that allows the operator to check output signals and ensure components are operable.

The control system consists of a processor module (PSIO-1), an EXD driver module (DSIO-EXV), a high voltage relay module on 30GX units (DSIO-HV), 2 six-pack relay boards, a keypad and display module (also called HSI0-II), 2 electronic expansion devices (EXDs), 1 compressor protection module (CPM) per compressor, a PSIO-2 module, 6 thermistors, and 8 transducers. A remote enhanced display is available as an accessory.

## MAJOR SYSTEM COMPONENTS

**Processor Module (PSIO-1)** — This module is an upgrade to the original PSIO (8088) module, with superior electrical noise immunity capability. It contains the operating software and controls the operation of the machine. It has 12 input channels and 6 output channels.

The PSIO-1 continuously monitors input/output channel information received from all the modules and controls all output signals for all output channels. It also controls the relays on the six-pack relay board. The processor module also controls the EXD driver module (as required), commanding it to open or close each EXD in order to maintain the proper cooler level. Information is transmitted between the processor module, CPM modules, the EXD driver module, and the HSIO-II standard display module through a 3-wire communications bus called COMM3. The remote enhanced display (accessory) is connected to the PSIO-1 module through a 3-wire communications bus, but uses a different communication bus called COMM1. The COMM1 bus is also used to communicate to other CCN (Carrier Comfort Network) devices when the unit is installed in a network application.

**DSIO-HV Relay Module** — The DSIO-HV module has 4 inputs and 8 outputs and is installed on 30GX units only. The module communicates the status of the inputs with the PSIO-1 module and operates the oil heater, outdoor fan, and minimum load control outputs.

**Electronic Expansion Device Module** — The electronic expansion device module has 4 inputs and 2 outputs. It receives signals from the PSIO-1 module and operates the electronic expansion devices. The electronic expansion device module also sends the PSIO-1 module the status of its 4 input channels.

**Compressor Protection Module (CPM)** — The compressor protection module monitors several of the compressor safeties and controls 4 of the outputs used to control each compressor. The CPM monitors compressor current, compressor voltage, high pressure switch status, and compressor motor temperature. The CPM controls the compressor contactors, oil solenoid, and motor cooling solenoid. Each CPM sends the PSIO-1 its circuit's motor temperature, alarm status of the module, and the compressor relay status.

**PSIO-2 (8052) Module** — This module is used as an input/output module only, as there is no unit software loaded in the module. This module has 12 input channels and 6 output channels.

**Keypad and Display Module (Also Called HSIO-II)** — This device consists of a keypad with 8 function keys, 4 operative keys, 12 numeric keys, and a 2-line 24-character alphanumeric LCD (liquid crystal display). Key usage is explained in the Accessing Functions and Subfunctions section on page 13.

**Control (LOR) Switch** — Control of the chiller is defined by the position of the LOCAL/OFF/REMOTE (LOR) switch. This is a 3-position manual switch that allows the chiller to be put under the control of its own controls (LOCAL), manually stopped (OFF), or controlled through a set of remote contacts (REMOTE). This switch is different than the switch that is used in the Flotronic™ II controls configuration. The CCN control is enabled through the HSIO-II. The switch allows unit operation as shown in Table 1.

In the LOCAL position, the chiller is allowed to operate and respond to the scheduling configuration, CCN configuration, and set point data. In the remote position, the unit operates similarly to the LOCAL position, except the remote contacts must be closed for the unit to operate.

**Table 1 — Unit Mode from LOR Switch and CCN State**

SWITCH POSITION	REMOTE CONTACTS	CCN CONFIGURATION	CCN STATE	UNIT MODE
OFF	NR	NR	NR	LOCAL OFF
LOCAL	NR	DISABLE	NR	LOCAL ON
		ENABLE	RUN	CCN ON
REMOTE	OPEN	NR	NR	LOCAL OFF
	CLOSED	DISABLE	NR	LOCAL ON
		ENABLE	RUN	CCN ON
			STOP	CCN OFF

### LEGEND

**CCN** — Carrier Comfort Network  
**NR** — Input Not Read by Processor

NOTE: If the unit is configured for a clock, then the unit is under clock control if it is in an ON mode.

## OPERATION DATA

**Electronic Expansion Device (EXD)** — The micro-processor controls the EXD through the EXD driver module. The EXD will either be an EXV (electronic expansion valve) or an economizer. Inside both these devices is a linear actuator stepper motor.

**EXV OPERATION** — High-pressure liquid refrigerant enters the valve through the bottom. A series of calibrated slots are located inside the orifice assembly. As refrigerant passes through the orifice, the pressure drops and the refrigerant changes to a 2-phase condition (liquid and vapor). To control refrigerant flow for different operating conditions, the sleeve moves up and down over the orifice, thereby changing orifice size. The sleeve is moved by a linear stepper motor. The stepper motor moves in increments and is controlled directly by the processor module. As the stepper motor rotates, motion is transferred into linear movement by the lead screw. Through the stepper motor and lead screw, 1500 discrete steps of motion are obtained. The large number of steps and long stroke result in very accurate control of refrigerant flow.

Each circuit has a liquid level sensor mounted vertically in the top of the cooler shell. The level sensor consists of a small electric resistance heater and 3 thermistors wired in series, positioned at different heights inside the body of the well. The heater is designed so that the thermistors read approximately 200 F (93.3 C) in dry air. As the refrigerant level rises (falls) in the cooler, the resistance of the closest thermistor(s) will increase (decrease) as it is cooled by the rising liquid refrigerant (heated by the heater). This large resistance difference allows the control to accurately maintain a specified level.

The level sensor monitors the refrigerant liquid level in the cooler and sends this information to the PSIO-1. At initial start-up, the EXV position is at zero. After that, the micro-processor keeps accurate track of the valve position in order to use this information as input for the other control functions. The processor does this by initializing the EXVs at start-up. The processor sends out enough closing pulses to the valve to move it from fully open to fully closed, then resets the position counter to zero. From this point on, until the next initialization, the processor counts the total number of open and closed steps it has sent to each valve.

**ECONOMIZER OPERATION** — Economizers are factory installed on 30GX105-265 units and 30HXA,C161-271 units. All other sizes use standard EXVs. The economizer improves both the chiller capacity and efficiency as well as providing compressor motor cooling. Inside the economizer are both a linear stepper motor (same as standard EXV motor) and a float valve. The stepper motor is controlled by the processor to maintain the desired liquid level in the cooler (as is done for chillers without economizers). The float valve maintains a liquid level in the bottom of the economizer.

Liquid refrigerant is supplied from the condenser through the end to the bottom of the economizer. A bubbler tube supplies a small amount of discharge gas to ensure that the float will be able to work properly. As the refrigerant passes through the EXD, its pressure is reduced to an intermediate level of about 75 psig (517 kPag). This pressure is maintained inside the economizer shell. Next, the refrigerant flows through the float valve where its pressure is further reduced to slightly above the pressure in the cooler.

The increase in performance is achieved when some of the refrigerant passing through the EXD flashes to vapor, further subcooling the liquid that is maintained at the bottom of the economizer. This increase in subcooling provides additional capacity. Also, since the additional power required to accomplish this is minimal, the efficiency of the machine improves. The vapor that flashes rises to the top of the economizer where it passes to the compressor and is used to provide motor cooling. After passing over the motor windings, the refrigerant reenters the cycle at an intermediate port in the compression cycle.

**Oil Pumps** — The 30GX/HX screw chillers use one externally mounted prelubricating oil pump per circuit. This pump is operated as part of the start-up sequence. On 30GX units, the pumps are mounted to the base rails on the oil separator side of the unit. The pumps are mounted to a bracket on the condensers of 30HXC units and to the oil separator on 30HXA units.

When a circuit is required to start, the controls energize the oil pump first and read the oil pressure transducer reading. The pump is operated for a period of 20 seconds, after which the oil solenoid is energized to open the oil inlet valve at the compressor. The control again reads the pressure from the oil pressure transducer. If the pump has built up sufficient oil pressure, the compressor is allowed to start.

Once the compressor has started, the oil pump is turned off within 10 seconds and is not used again until the next start-up. If the pump is not able to build up enough oil pressure, the pump is turned off. Within 3 seconds, the pump is re-energized and makes one additional attempt to build oil pressure. The control generates an alarm if the second attempt fails.

**Motor Cooling** — Compressor motor winding temperatures are controlled to a set point of 200 F (93.3 C). The control accomplishes this by cycling the motor cooling solenoid valve to allow liquid refrigerant to flow across the motor windings as needed. On units equipped with economizers, flash gas leaves the top of the economizer and continually flows to the motor windings. All refrigerant used for motor cooling re-enters the rotors through a port located midway along the compression cycle and is compressed to discharge pressure.

## **Back Pressure Valve (30GX and 30HXA only)**

— This valve is located on the oil separator outlet on 30GX units and mounted on the oil separator shell of 30HXA units. The valve's function is to ensure that there is sufficient system differential pressure to allow for oil to be driven back to the compressor. A small copper line (economizer pressure) is connected to the top of the valve, which contains an internal spring that closes a piston if the pressure in the oil separator is not at least 15 psig greater than the economizer pressure.

**Sensors** — The 30GX,HX control system (based on the Flotronic™ II chiller control system) gathers information from sensors to control the operation of the chiller. The units use up to 9 standard pressure transducers, 7 standard thermistors (including 3 motor temperature thermistors), and 2 liquid level thermistors to monitor and control system operation. The sensors are listed in Table 2.

**Compressor Protection Module (CPM)** — Each compressor has its own CPM. The CPM provides the following functions:

- compressor main contactor control
- Wye-Delta contactor transition
- compressor ground current protection
- motor temperature reading
- high-pressure protection
- reverse rotation protection
- voltage imbalance protection
- current imbalance protection
- compressor oil solenoid control
- motor cooling solenoid control
- sensor bus communications
- starting and running overcurrent protection

The CPM has the following 4 output relays and 4 inputs:



### **OUTPUTS:**

- compressor contactor
- compressor oil solenoid
- compressor motor cooling solenoid
- Wye-Delta transition relay

### **INPUTS:**

- motor temperature
- three-phase voltage
- three-phase current
- high-pressure switch

A diagram of the CPM board is shown in Fig. 1. There are line voltage inputs at L1, L2, and L3. Below these inputs are the current toroid inputs at Plug 1. Below Plug 1 are the 3 COMM3 communication terminals. In the lower left corner of the board are the inputs for motor winding temperature. The address DIP (dual-in-line package) switch and compressor must-trip amps header are factory set. For compressor A1, switches 2 and 4 should be set. For compressor A2 (30HXA,C206-271 AND 30GX205-265), switches 2, 3, and 4 should be set. For compressor B1, switches 1 and 4 should be set.

To verify proper must trip amps header configuration, press   and use the up arrow key on the HSIO to locate the must trip amp values. Press the reset button on the HSIO/fuse panel to update these values. See Appendix A. If the values do not match those in Appendix A, verify with Appendix D that the configuration headers have been properly punched out.

**Table 2 — Thermistor and Transducer Locations**

THERMISTORS			
Sensor	Description	Location	Connection Terminals
T1	Cooler Leaving Fluid Temp	Cooler Head Leaving Fluid Side	PSIO-2, J7 pins 2,3
T2	Cooler Entering Fluid Temp	Cooler Head Entering Fluid Side	PSIO-2, J7 pins 5,6
Motor Temp A1	Motor Temperature A1	Compressor A1 Junction Box	CPM-A1, T terminals
Motor Temp A2*	Motor Temperature A2	Compressor A2 Junction Box	CPM-A2, T terminals
Motor Temp B1	Motor Temperature B1	Compressor B1 Junction Box	CPM-B1, T terminals
T5	Discharge Gas Temp A	Top of Condenser Circuit A (30HXC Only) Top of Oil Separator Circuit A (All Other Units)	PSIO-2, J7 pins 8,9
T6	Discharge Gas Temp B	Top of Condenser Circuit B (30HXC Only) Top of Oil Separator Circuit B (All Other Units)	PSIO-2, J7 pins 11,12
LL-A (T3)	Liquid Level Circuit A	Top of Cooler Circuit A	PSIO-1, J7 pins 5,6
LL-B (T4)	Liquid Level Circuit B	Top of Cooler Circuit B	PSIO-1, J7 pins 8,9
T7 (optional)†	Outdoor Air Thermistor	Outside Air Stream	PSIO-2, J7 pins 20,21
STP (optional)†	Space Temperature	Conditioned Space	PSIO-2, J7 pins 23,24
T8 (optional)†	Condenser Entering Water Temp	Condenser Entering Fluid Line	PSIO-2, J7 pins 14,15
T9 (optional)†	Condenser Leaving Water Temp	Condenser Leaving Fluid Line	PSIO-2, J7 pins 17,18
PRESSURE TRANSDUCERS			
Sensor	Description	Location	Connection Terminals
DPT-A	Discharge Pressure Circuit A	Top of Condenser Circuit A (30HXC Only) Top of Oil Separator Circuit A (All Other Units)	PSIO-1, J7 pin 22
SPT-A	Suction Pressure Circuit A	Top of Cooler Circuit A	PSIO-1, J7 pin 19
EPT-A	Economizer Pressure Circuit A	Economizer Line Entering Comp A	PSIO-1, J7 pin 10
OPT-A1	Oil Pressure Compressor A1	Compressor A1 Oil Connection	PSIO-1, J7 pin 25
OPT-A2*	Oil Pressure Compressor A2	Compressor A2 Oil Connection	PSIO-1, J7 Pin 1
DPT-B	Discharge Pressure Circuit B	Top of Condenser Circuit B (30HXC Only) Top of Oil Separator Circuit B (All Other Units)	PSIO-1, J7 pin 16
SPT-B	Suction Pressure Circuit B	Top of Cooler Circuit B	PSIO-1, J7 pin 31
EPT-B	Economizer Pressure Circuit B	Economizer Line Entering Comp B	PSIO-1, J7 pin 13
OPT-B	Oil Pressure Compressor B	Compressor B1 Oil Connection	PSIO-1, J7 pin 28

\*30HX206-271 only.

†Sensors are available as accessories for field installation.

The CPM communicates on the COMM3 communication bus to the PSIO-1 module. Proper operation of the CPM board can be verified by observing the 3 LEDs (light-emitting diodes) located on the board. The top LED is red and blinks at a rate of once every 1 to 2 seconds. This indicates that the module is powered and operating correctly. The middle LED is yellow and blinks when there is an automatic reset alarm condition. The yellow LED remains on and does not blink for manual reset alarm conditions. The bottom LED is green and blinks when the module is satisfactorily communicating with the PSIO-1 module. The CPM communicates the status of its inputs and outputs, and reports 18 different alarm conditions to the PSIO-1. The alarms are listed in Table 3.

**⚠ CAUTION**

The CPM module has many features that are specifically designed to protect the compressor, including reverse rotation protection. Do not attempt to bypass or alter any of the factory wiring. Any compressor operation in the reverse direction will result in a compressor failure that will require compressor replacement.

The PSIO-1 will generate an alert when it receives an alarm input from the CPM. The alert will be generated in a y.xx format, where “y” refers to the compressor and “xx” to the alarm value in Table 3 (decimal point removed). For example, the HSIO might display Alarm 1.70 for a voltage phase reversal occurring on compressor A1. Similarly, the display would read 5.85 for a motor overtemperature condition on compressor B1. Alerts for compressors A2 and B2 (if present) would be generated as “2.xx” and “6.xx,” respectively. Alarm codes 3 and 4 would not be used. Ending zeros are not displayed.

The high-pressure switch is wired in series with the relay coils of the 4 relays on the CPM. If this switch opens during

operation, all relays on the CPM are deenergized and the compressor is stopped. The failure is reported to the PSIO-1 and the processor module locks off the compressor from re-starting until the alarm is manually reset.

**Table 3 — Compressor Protection Module Feedback Codes**

ALARM CONDITION	VALUE
High Pressure Switch Trip	1.0
No Motor Current	2.0
Current Imbalance Alarm 10%	2.5
Current Imbalance Warning 10%	2.7
Current Imbalance 18%	3.0
Single Phase Current Loss	3.5
High Motor Current	4.0
Ground Fault	5.0
Voltage Imbalance Alarm 3%	5.5
Voltage Imbalance Warning 3%	5.7
Voltage Imbalance 7%	6.0
Voltage Phase Reversal	7.0
Contactors Failure	7.5
Current Phase Reversal	8.0
Motor Overtemperature	8.5
Open Thermistor	9.0
Configuration Header Fault	9.5
Shorted Thermistor	10.0
No Error	0

**Wye-Delta vs Across-the-line (XL) Starting Option**

— All 30GX,HX chillers operating at voltages of 208/230-3-60 or 230-3-50 (5 or 8 at Position 12 in model number) are supplied with factory installed Wye-Delta starters. All other voltage options can be ordered with either Wye-Delta or XL starting options. The XL starting method is the most cost effective and simply starts the compressor motor in a Delta configuration (the motors are designed for continuous operation in this configuration) using a single contactor. See Fig. 2. This is the simplest starting method to use and is ideal where starting current does not require limiting.

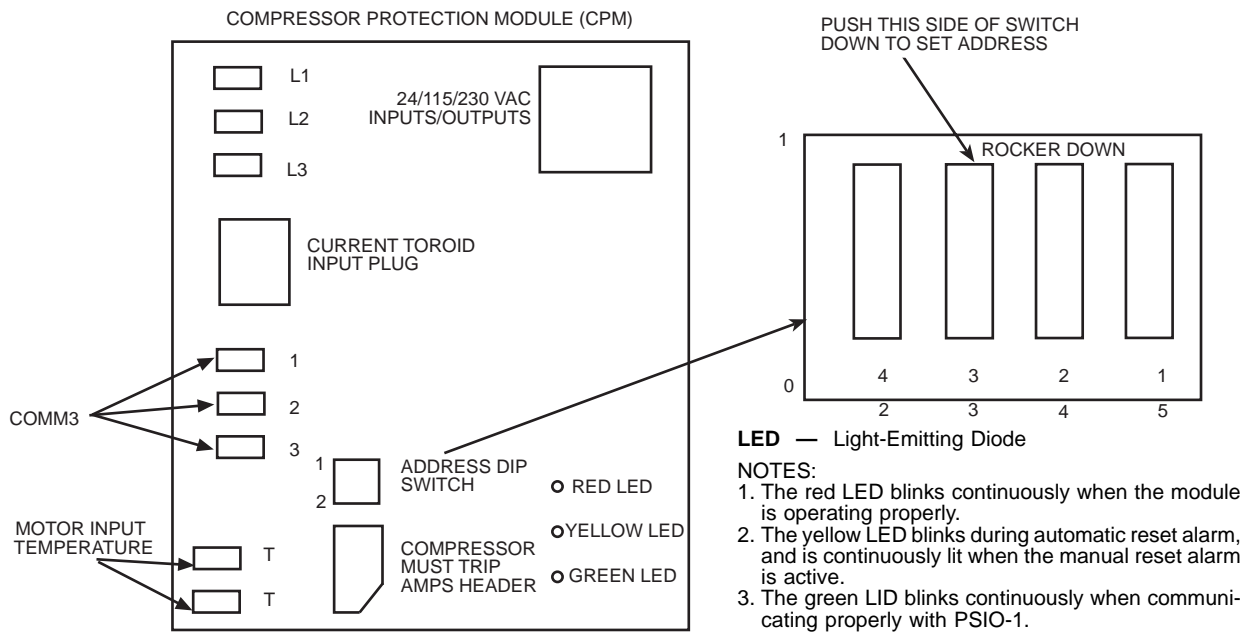


Fig. 1 — Compressor Protection Module

Where current limitations exist, the Wye-Delta option may be used. See Fig. 3. This option uses a factory-installed starter assembly for each compressor, which consists of 3 contactors labelled 1M, 2M, and S. As the compressor is started, the CPM module energizes contactors 1M and S, which connects and energizes the motor windings in a Wye configuration. The starting current required will be approximately 60% less than that required for an XL start due to the higher impedance of the motor windings when Wye connected. The compressor will attain about 100% of its normal operating speed (approximately 3 to 6 seconds) before the CPM module deenergizes the S contactor and energizes the 2M contactor, switching the compressor windings to a Delta wiring configuration. The S and 2M contactors in the starter assembly are both mechanically and electrically interlocked so that they will not both be energized at the same time.

*Do not alter the factory-installed power wiring from the control box terminal block to the compressor junction block. Doing so will cause permanent damage to the compressor and will require that the compressor be replaced.*

**Capacity Control** — The control system cycles compressors, loaders, and minimum load control valves to maintain the user-configured leaving chilled fluid temperature set point. Entering fluid temperature is used by the microprocessor to determine the temperature drop across the cooler and is used in determining the optimum time to add or subtract capacity stages. The chilled fluid temperature set point can be automatically reset by the return temperature reset or space and outdoor-air temperature reset features. It can also be reset from an external 4 to 20 mA signal (requires field-supplied 500-ohm, ½ watt resistor), or from a network signal.

The capacity routine runs every 30 seconds. The routine attempts to maintain the Control Point at the desired set point. Each time it runs, the control reads the entering and leaving fluid temperatures. The control determines the rate at which conditions are changing and calculates 2 variables based on these conditions. Next, a capacity ratio (Load/Unload Factor under  $\boxed{1} \boxed{0} \boxed{\text{STAT}}$ ) is calculated using the 2 variables to determine whether or not to make any changes to the current stages of capacity. This ratio value ranges from - 100 to + 100%. If the next stage of capacity is a compressor, the

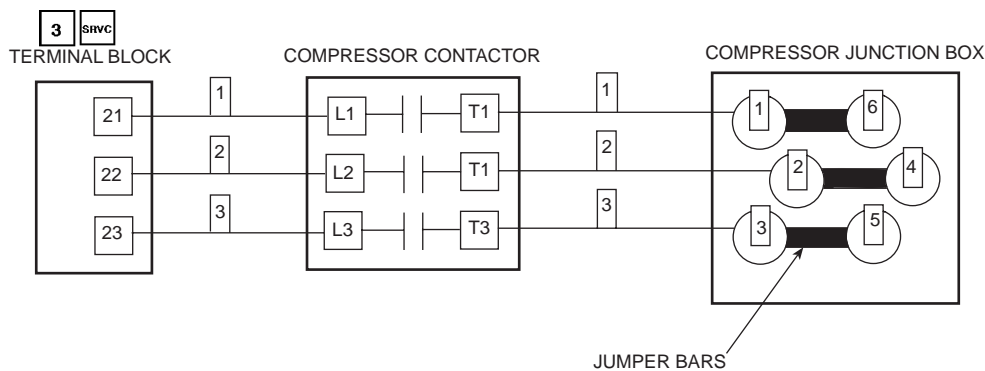
control starts (stops) a compressor when the ratio reaches + 100% (- 100%). If the next stage of capacity is a loader, the control energizes (deenergizes) a loader when the ratio reaches + 60% (- 60%). Loaders are allowed to cycle faster than compressors, to minimize the number of starts and stops on each compressor. A delay of 90 seconds occurs after each capacity step change.

**MINUTES LEFT FOR START** — This value is displayed in the Status subfunction and represents the amount of time to elapse before the unit is started. This value can be zero without the machine running in many situations. This can include being unoccupied, LOR switch in the OFF position, CCN not allowing unit to start, Demand Limit in effect, no call for cooling due to no load, and alarm or alert conditions present. If the machine should be running and none of the above are true, a minimum off time may be in effect. The machine should start normally once the time limit has expired.

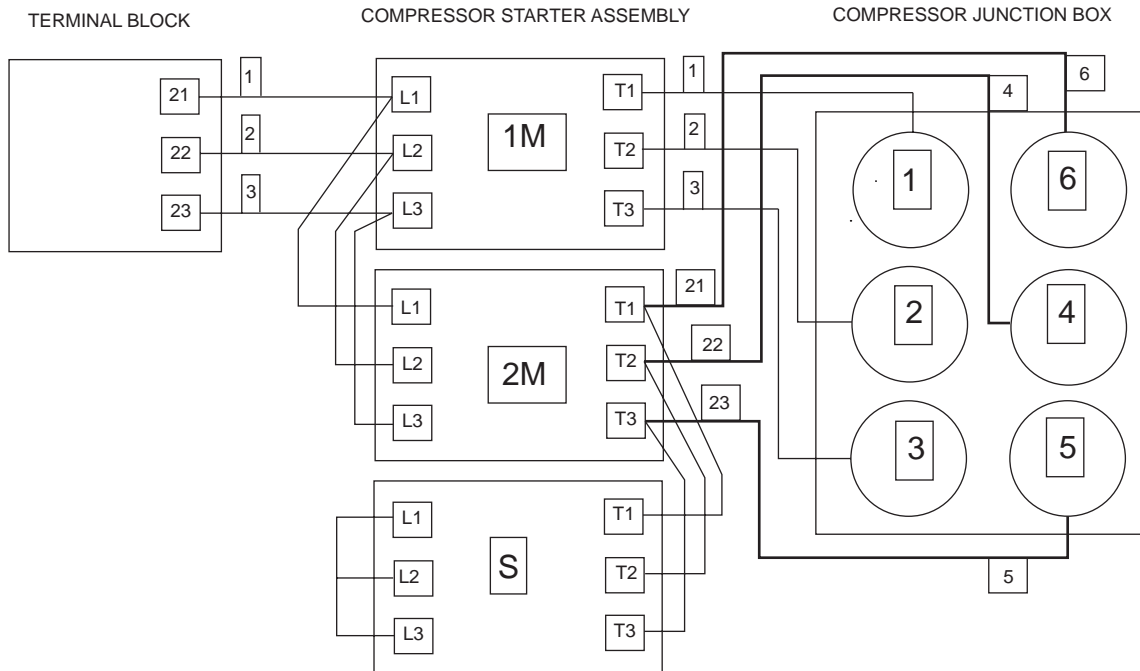
**MINUTES OFF TIME** ( $\boxed{1} \boxed{\text{SET}}$ ) — This user configurable time period is used by the control to determine how long unit operation is delayed after power is applied/restored to the unit. It is also used to delay compressor restarts after the unit has shut off its lowest stage of capacity. Typically, this time period is configured when multiple machines are located on a single site. For example, this gives the user the ability to prevent all the units from restarting at once after a power failure. A value of zero for this variable does not mean that the unit should be running.

**LOADING SEQUENCE** — The 30GX,HX chiller efficiency is greatest at full load. Therefore, the following sequence list applies to capacity control.

1. The next compressor is not started until all others are running at 100%.
2. The second unloading stage is only used during initial capacity staging of the unit at start-up.
3. Whenever a compressor is started in a circuit, the loaders in the circuit are deenergized for 15 seconds before the compressor is started. The loaders are energized 90 seconds after the compressor is started.



**Fig. 2 — Across-the-Line (XL) Compressor Wiring**



**Fig. 3 — Wye-Delta Compressor Wiring**

**CLOSE CONTROL (3 SHVC)** — When configured for Close Control, the control is allowed to use any loading/capacity control devices required to maintain better leaving fluid temperature regulation. All stages of unloading are available. See Appendix B for an example.

**LEAD/LAG DETERMINATION (2 SHVC)** — This is a configurable choice and is factory set to be automatic. The value can be changed to Circuit A or Circuit B leading, as desired. Set at automatic, the control will sum the current number of logged circuit starts and one-quarter (Version 3.0 and later) of the current operating hours for each circuit. The circuit with the lowest sum is started first. Changes to which circuit is the lead circuit and which is the lag are made when shutting off compressors.

On 30HX206-271 and 30GX205-265 units set for staged loading, the control fully loads the lead circuit before starting the lag circuit and unloads the lag circuit first. When these units are set for equal loading, the control maintains nearly equal capacities in each circuit when the chiller is loading and unloading.

**CAPACITY SEQUENCE DETERMINATION (2 SHVC)** — This is configurable as equal circuit loading or staged circuit loading with the default set at staged. The control determines the order in which the steps of capacity for each circuit are changed. This control choice does NOT have any impact on machines with only 2 compressors.

**MINIMUM LOAD VALVE (2 SHVC)** — When this option is installed and configured, the first stage of capacity is initiated by energizing the Minimum Load valve relay. The control energizes loaders as needed thereafter. Similarly, the Minimum Load valve relay will be energized for the last stage of capacity to be used before the circuit is shut down.

**CAPACITY CONTROL OVERRIDES** — The following overrides will modify the normal operation of the routine.

**Deadband Multiplier** — The user configurable Deadband Multiplier (3 SHVC) has a default value of 1.0. The range is from 1.0 to 4.0. When set to other than 1.0, this factor is applied to the capacity Load/Unload Factor. The larger this value is set, the longer the control will delay between adding or removing stages of capacity. Figure 4 shows how compressor starts can be reduced over time if the leaving water temperature is allowed to drift a larger amount above and below the set point. This value should be set in the range of 3.0 to 4.0 for systems with small loop volumes.

**First Stage Override** — If the current capacity stage is zero, the control will modify the routine with a 1.2 factor on adding the first stage to reduce cycling. This factor is also applied when the control is attempting to remove the last stage of capacity.

DEADBAND EXAMPLE

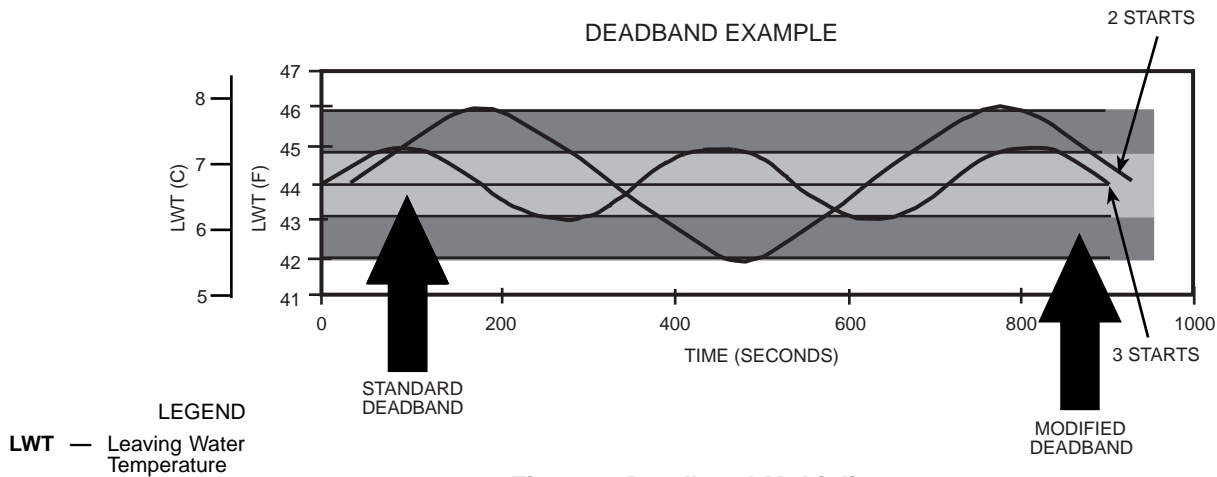


Fig. 4 — Deadband Multiplier

**Slow Change Override** — The control prevents the capacity stages from being changed when the leaving fluid temperature is close to the set point (within an adjustable deadband) and moving towards the set point.

**Ramp Loading** ( ) — Limits the rate of change of leaving fluid temperature. If the unit is in a cooling mode and configured for Ramp Loading, the control makes 2 comparisons before deciding to change stages of capacity. The control calculates a temperature difference between the control point and leaving fluid temperature. If the difference is greater than 4° F (2.2° C) and the rate of change (°F or °C per minute) is less than the configured Cooling Ramp Loading value ( ) , the control does not allow any changes to the current stage of capacity.

**Low Entering Fluid Temperature Unloading** — When the entering fluid temperature is below the control point, the control will attempt to remove 25% of the current stages being used. If exactly 25% cannot be removed, the control removes an amount greater than 25%, but no more than necessary. The lowest stage will not be removed.

**Low Discharge Superheat** — If a circuit’s discharge superheat is less than 15° F (8.3° C), the control does not increase the current capacity stage and the EXD is not opened any further. If the discharge superheat is less than 10° F (5.6° C) and decreasing, the EXD is closed 50 steps every 10 seconds. If the discharge superheat is less than 5° F (2.8° C) and decreasing, the circuit is unloaded every 30 seconds until the superheat is greater than 5° F (2.8° C). The final capacity stage is not unloaded unless an alarm condition exists. This override is ignored for the first 3 minutes after a compressor is started.

**Low Saturated Suction Temperature** — To avoid freezing the cooler, the control will compare the circuit Saturated Suction temperature with a predetermined freeze point. For water circuits, the freeze point is 28 F (–2.2 C). For brine circuits, the freeze point is 8° F (4.4° C) below the cooling set point (lower of 2 cooling set points for dual configuration). If the saturated suction temperature is below the freeze point, the unit capacity is not allowed to increase. For brine circuits, the freeze point can be entered by pressing   and scrolling 12 items down. The control will use the Brine Freeze Point value less 6°F (3.3°C) as the freeze point to compare with the Saturated Suction temperature. The default for the Brine Freeze Point is 34 F (1.1 C) which means the control will use 28 F (–2.2 C) as the freeze point. This value is adjustable from –15 F to 34 F (–26.1 to 1.1 C). For

water (brine) circuits, if the Saturated Suction temperature falls below 34 F (1.1 C) (the Brine Freeze Point), the unit capacity will not increase. If the Saturated Suction temperature falls below 28 F (–2.2 C), the Brine Freeze Point minus 6° F (3.3° C), for 90 seconds, all loaders in the circuit are turned off. If this condition continues for a total of 3 minutes, the circuit will shut down.

**High Condensing Temperature Unloading** — Every 10 seconds the control checks for the conditions below. Loaders will be cycled as needed to control the saturated condensing temperature below the configured maximum condensing temperature. Configured maximums are 154 F (67.8 C) for 30GX, 152 F (66.7 C) for 30HXA, and 122 F (50 C) for 30HXC units. If a circuit’s saturated condensing temperature is more than 12° F (6.7 C) below the maximum condensing temperature, the circuit capacity is not allowed to increase. If the saturated condensing temperature is more than 2° F (1.1° C) above the maximum condensing temperature for 60 seconds, a loader is turned off. If the saturated condensing temperature rises to more than 5° F (2.8° C) above the maximum condensing temperature during the 60 seconds, a loader is turned off immediately. If all the loaders were already off, the compressor is shut down and an alarm is generated.

**MOP (Maximum Operating Pressure) Override** — The control monitors saturated condensing and suction temperature for each circuit as well as differential oil pressure. Based on a configurable maximum operating set point (saturated suction temperature), set maximum condensing temperature, and minimum differential oil pressure, the control may reduce the number of capacity stages being used and/or may lower the EXD position when system pressures approach the set parameters.

**Head Pressure Control**

**GENERAL** — The microprocessor controls the condenser fans (30GX) or analog water valve (30HXC) to maintain the saturated condensing temperature to a configurable set point. The fans are staged or speed varied (30GX) or water valve controlled (30HX) based on each circuit’s saturated condensing temperature and compressor status. Water cooled units (30HXC) operating at less than 70 F (21.1 C) for entering condenser water require the use of head pressure control.

The chiller must be field configured for the options shown in Table 4. Fan stage settings are shown in Table 5.

**AIR COOLED UNITS (30GX)** — See Fig. 5 for condenser fan locations.



No Motormaster® Control — The fans are controlled based on Saturated Condensing Temperature. The first fan stage for each circuit is turned on whenever the compressor is turned on. A fan stage is added when the Saturated Condensing Temperature (SCT) exceeds the Head Pressure Set Point. The Head Pressure Set Point is configurable in the Set Point sub-function. The default is 113 F (45 C). Once a fan stage has been added, the software temporarily modifies the head pressure set point by adding 15° F (8.3° C) for 35 seconds. A fan stage will be removed when the Saturated Condensing Temperature has been less than the Head Pressure Set Point minus 35 F (19.4 C) for 2 minutes. The control uses the higher of the 2 Saturated Condensing Temperature values for 30GX080-150 and 160 units. For the 30GX151 and 161-265 units, each circuit's fan stages are independently controlled based on the circuit Saturated Condensing Temperature. Refer to Table 6 for condenser fan control information. See Fig. 6A.

With Motormaster Control — For low-ambient operation, the lead fan in each circuit can be equipped with the optional or accessory Motormaster III head pressure controller. This controller can be used in one of 2 ways. If factory installed, the controller will be configured for 4 to 20 mA control. With the Motormaster III option enabled, the PSIO-1 module calculates the required output based on Saturated Condensing temperature, Head Pressure set point, and a PID (proportional integral derivative) loop calculation. This 4 to

20 mA output is driven through the PSIO-2 module. To obtain this accessory for field installation, order by part number 30GX-900---012 for a single controller package (30GX080-150 and 160). Order part number 30GX-900---014 for a dual controller package (30GX151 and 161-265). These packages contain all the hardware required to install the accessory. See Fig. 6B.

The control will use the higher of the 2 Saturated Condensing Temperature values for 30GX080-150 and 160 units. For the 30GX151 and 161-265 units, each circuit's fan stages are independently controlled based on the circuit Saturated Condensing Temperature. Refer to Table 6 for condenser fan staging information.

WATER-COOLED UNITS (30HX) — The 30HX chillers can be configured to control direct or reverse-acting water valves that are controlled by a 4 to 20 mA signal. A 2 to 10 VDC signal can be used by installing a 500-ohm resistor across the 2 output terminals of the 4 to 20 mA signal. This control scheme reads the saturated condensing temperature and uses a PID (proportional integral derivative) loop to control the head pressure. Proportional, Integral and Derivative gain parameters for both the water and air cooled controls are adjustable and can be found in the Service subfunction. Checkout and adjustment of the PID loop should only be performed by certified Carrier Comfort Network technicians.

**Table 4 — Field Configured Chiller Options**

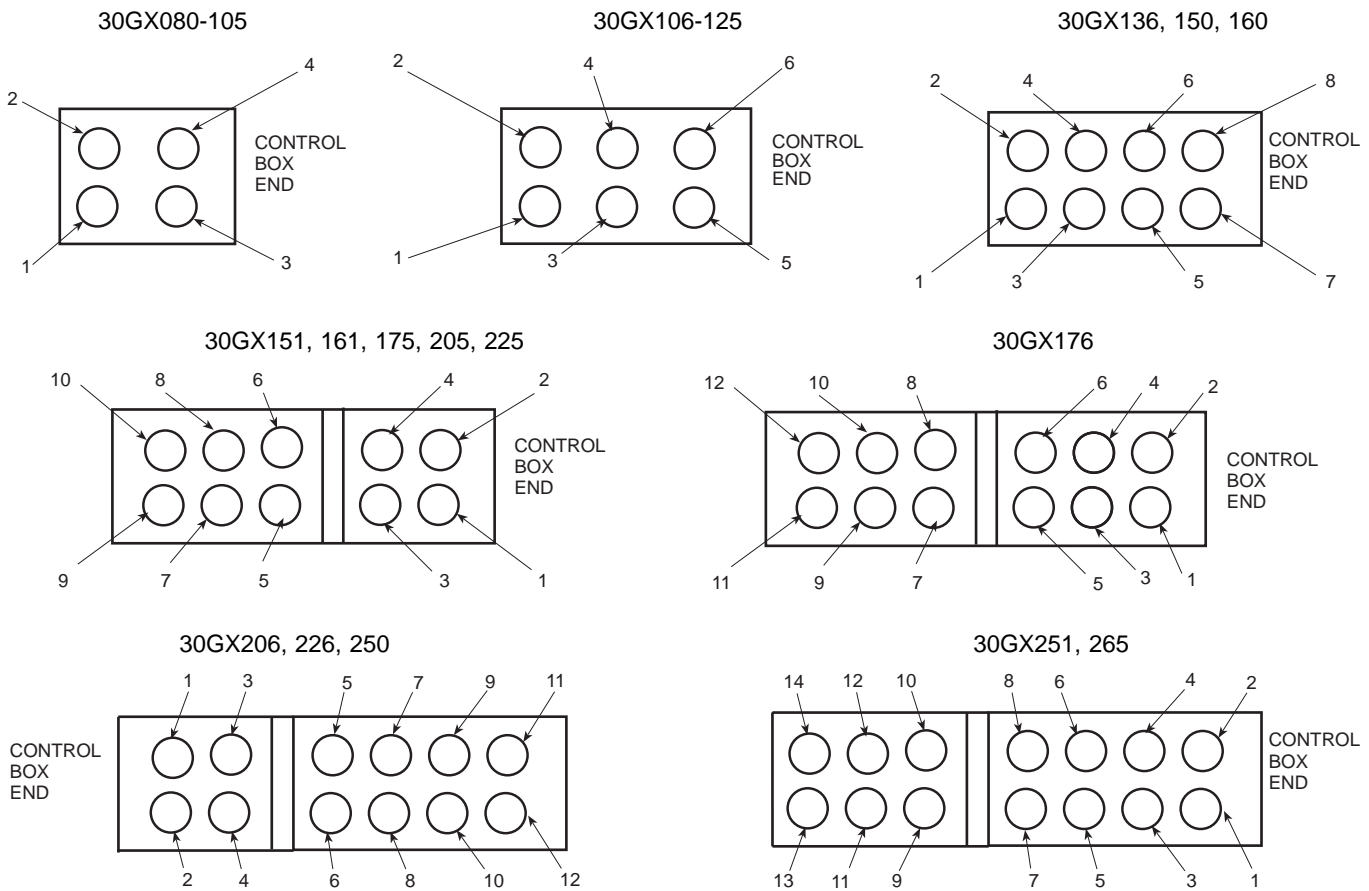
CONFIGURATION OPTION	DESCRIPTION	HSIO LOCATION	FACTORY CONFIGURED?
Fan Staging Select	Air cooled staging method		Yes. See Table 5
Motormaster Control Select	Applies to air cooled units only		Yes. 0 = None Set to 1 to enable (Motormaster only)
Water Valve Type	Applies to water cooled unit only		Yes. 0 = None Set to 1 = 4 – 20 mA, 2 = 0 – 10 V, 3 = 20 – 4 mA, 4 = 10 – 0 V

**Table 5 — Fan Staging Settings for Air Cooled (30GX) Units**

UNIT 30GX	DESCRIPTION	OPTION NUMBER
080-105	1st stage compressor status 2nd stage common control based on highest SCT	12
106-125	1st stage compressor status 2nd and 3rd stage common control based on highest SCT	14
136, 150, 160	1st stage compressor status 2nd through 4th stage common control based on highest SCT	16
151, 161, 175, 205, 225	1st stage each circuit, compressor status 2nd stage Circuit B independent 2nd and 3rd stage Circuit A independent	7
176	1st stage each circuit, compressor status 2nd and 3rd stage each circuit independent	3
206, 226, 250	1st stage each circuit, compressor status 2nd stage Circuit B independent 2nd, 3rd and 4th stage Circuit A independent	9
251, 265	1st stage each circuit, compressor status 2nd, 3rd and 4th stage each circuit independent	5

LEGEND

SCT — Saturated Condensing Temperature



**Fig. 5 — 30GX Condenser Fan Locations**

**ADJUSTING PID ROUTINES** — The 30GX and 30HXC head pressure control routines use PID (proportional integral derivative) loops to maintain a user-configurable head pressure set point. Gain default values are located in the Service function. See page 30. The current values can be read under  4  SRVC from the HSIO. The control calculates a new fan speed (30GX) or water valve position (30HXC) every 5 seconds based on these gain values and an error term equal to saturated condensing temperature minus head pressure set point. If the control routine is not responding fast enough to large changes (circuit starting, for example), increase the proportional term.

When the routine is making too great a change to valve position or fan speed, decrease the proportional term. To minimize hunting, keep the integral term positive and as low as possible. The default for the derivative term is zero. This valve is used to control “droop,” which is common in master/submaster control schemes. The value should not need to be changed.

### Cooler and Condenser (30HXC) Pump Control

— The 30GX and 30HX chillers can be configured for cooler and condenser (30HXC) pump control. Inputs for a cooler flow switch or interlock and condenser flow switch are also provided.

**COOLER PUMP CONTROL** (  2  SRVC ) — The factory default setting for cooler pump control is “Not Controlled.” All chillers are enabled at the factory for cooler pump interlock. See page 71 of Field Wiring section for wiring of cooler flow switch and/or cooler pump interlock contacts. Whether cooler pump control is enabled or not, the control generates an alarm if this input does not close within one minute after the unit switches to an occupied mode or the cooler pump is turned on. See Alarms and Alerts section, page 43 for a description of Alarms 53-55. If cooler pump control is enabled, the control waits one minute and checks the interlock or switch input before starting to determine if cooling is needed. The cooler pump is turned on when the chiller is in the occupied mode and turned off otherwise. The cooler pump is turned on in either of two override conditions: If the cooler freeze protection alarm has been generated, the cooler pump is turned on if not already running. If a cooler heater is being used and has been on for more than 15 minutes during saturated suction freeze protection, the cooler pump is turned on.

**Table 6 — 30GX080-265 Condenser Fan Staging (PSIO-1 Controlled)**

30GX UNIT SIZE	FAN TYPE	FAN CONTACTOR	FANS CONTROLLED	FAN RELAY NO.*
080-105	Standard	FC-1	1, 2	5
		FC-2	3, 4	1
	High Static	FC-1, 1A	1, 2	5
		FC-2, 2A	3, 4	1
106-125	Standard	FC-1	1, 2	5
		FC-2	3, 4	1
		FC-3	5, 6	2
	High Static	FC-1, 1A	1, 2	5
		FC-2, 2A	3, 4	1
		FC-3, 3A	5, 6	2
136, 150, 160	Standard	FC-1	1, 2	5
		FC-2	3, 4	1
		FC-3	5, 6	2
		FC-4	7, 8	2
	High Static	FC-1, 1A	1, 2	5
		FC-2, 2A	3, 4	1
		FC-3, 3A	5, 6	2
		FC-4, 4A	7, 8	2
151, 161, 175, 205, 225	Standard	FC-1	1, 2	Comp. B1 contactor†
		FC-2	3, 4	3
		FC-3	5, 6	2
		FC-4	7, 8	Comp. A1/A2 contactor†
		FC-5	9, 10	1
	High Static	FC-1, 1A	1, 2	Comp. B1 contactor†
		FC-2, 2A	3, 4	3
		FC-3, 3A	5, 6	2
		FC-4, 4A	7, 8	Comp. A1/A2 contactor†
		FC-5, 5A	9, 10	1
176	Standard	FC-1	1, 2	Comp. B1 contactor†
		FC-2	3, 4	3
		FC-3	5, 6	4
		FC-4	7, 8	Comp. A1 contactor†
		FC-5	9, 10	1
		FC-6	11, 12	2
	High Static	FC-1, 1A	1, 2	Comp. B1 contactor†
		FC-2, 2A	3, 4	3
		FC-3, 3A	5, 6	4
		FC-4, 4A	7, 8	Comp. A1 contactor†
206, 226, 250	Standard	FC-1	1, 2	Comp. B1 contactor†
		FC-2	3, 4	3
		FC-3	5, 6	1
		FC-4	7, 8	Comp. A1/A2 contactor†
		FC-5	9, 10	2
		FC-6	11, 12	2
	High Static	FC-1, 1A	1, 2	Comp. B1 contactor†
		FC-2, 2A	3, 4	3
		FC-3, 3A	5, 6	1
		FC-4, 4A	7, 8	Comp. A1/A2 contactor†
		FC-5, 5A	9, 10	2
		FC-6, 6A	11, 12	2
251, 265	Standard	FC-1	2, 4	1
		FC-2	6, 8	2
		FC-3	1	Comp. B1 contactor†
		FC-4	3	3
		FC-5	5, 7	4
		FC-6	9, 10	Comp. A1/A2 contactor†
		FC-7	11, 12	2
		FC-8	13, 14	2
	High Static	FC-1, 1A	2, 4	1
		FC-2, 2A	6, 8	2
		FC-3	1	Comp. B1 contactor†
		FC-4	3	3
		FC-5, 5A	5, 7	4
		FC-6, 6A	9, 10	Comp. A1/A2 contactor†
		FC-7, 7A	11, 12	2
		FC-8, 8A	13, 14	2

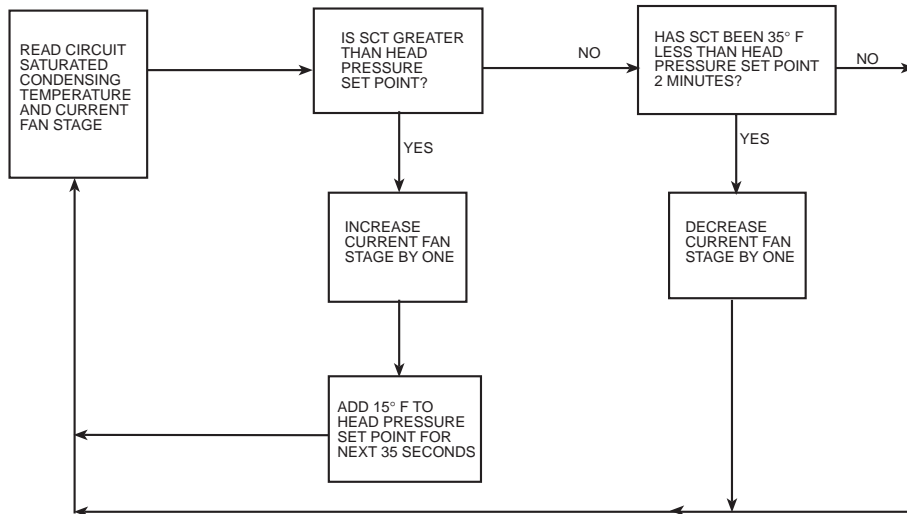
**LEGEND**

**Comp.** — Compressor  
**FC** — Fan Contactor

\*Fan Relay number displayed when using  3  TEST to test fans.

†Proper rotation of these fans to be checked when compressor(s) is running. See Fig. 5 for condenser fan locations when viewing from the control box end.

30GX UNITS — MOTORMASTER III CONTROL NOT INSTALLED

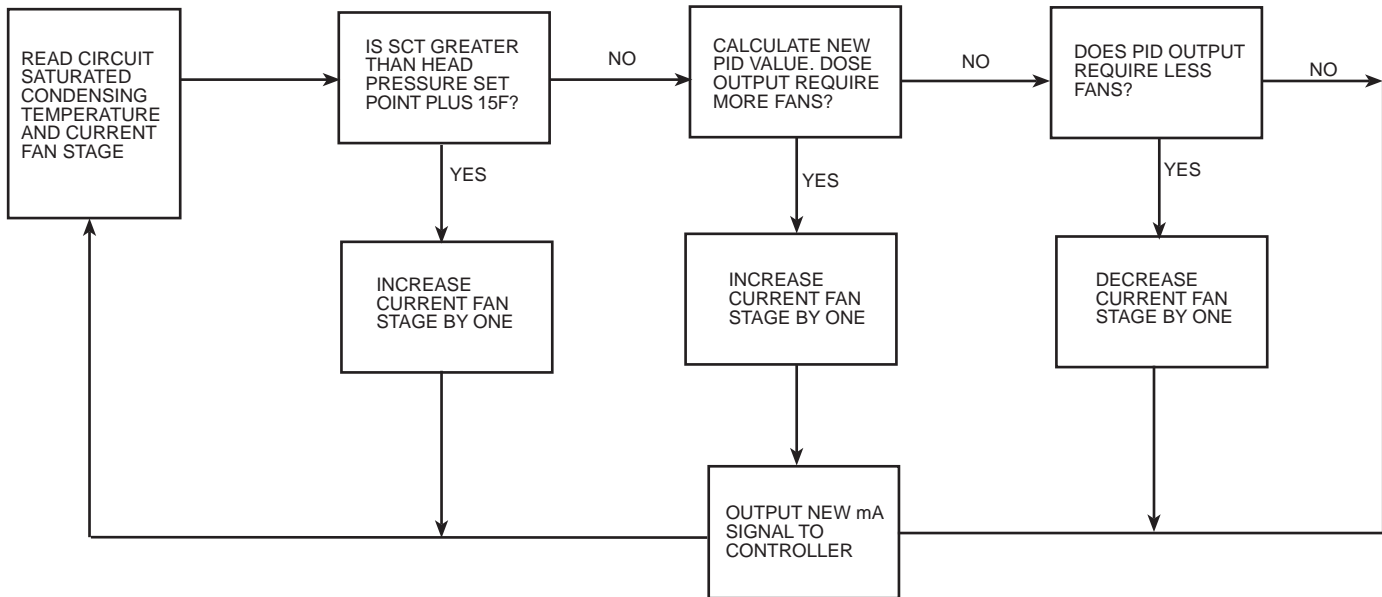


LEGEND

SCT — Saturated Condensing Temperature

Fig. 6A — 30GX Head Pressure Control Without Motormaster® III Control

30GX UNITS — MOTORMASTER III CONTROL INSTALLED



LEGEND

PID — Proportional Integral Derivative  
 SCT — Saturated Condensing Temperature

Fig. 6B — 30GX Head Pressure Control With Motormaster III Control

CONDENSER PUMP CONTROL (  2  SRVC ) — Factory defaults for both condenser pump control and condenser flow switch are set to “Not Controlled” and “Disabled,” respectively. The condenser pump can be controlled in one of two ways: In the first method, the pump can be controlled like the cooler pump — it is turned on whenever the machine is in the on state and turned off otherwise (set to Type 1 using

the Service function). The second method of control is to turn the pump on when the first compressor is started and off when the last compressor is turned off (set to Type 2 using the Service function). With the flow switched enabled, the control checks the status of the input one minute after starting the pump. An alarm is generated if the flow switch input is not closed.

**Cooler Heater Control** — Accessory cooler heaters can be ordered for the 30GX chillers. If installed and enabled, these heaters are turned on only when the machine is in the off state and the chiller is in a saturated suction temperature freeze condition.

**Keypad and Display Module (Also Called HSIO-II)** — This module allows the operator to communicate with the processor. It is used to enter configurations and set points and to read data, perform tests, and set schedules. The device consists of a keypad with 7 function keys, 5 operative keys, 12 numeric keys (0 to 9, •, and -), and a 2-line, 24-character alphanumeric liquid crystal display. See Fig. 7.

**ACCESSING FUNCTIONS AND SUBFUNCTIONS** — Table 7 shows a brief description of the keypad buttons. Table 8A shows the 6 functions (identified by name) and the subfunctions (identified by number). Table 8B shows the 6 functions (identified by name) and the subfunctions (identified by number) when using the optional LID-2B controller. Table 9 shows a brief example on how to access subfunctions.

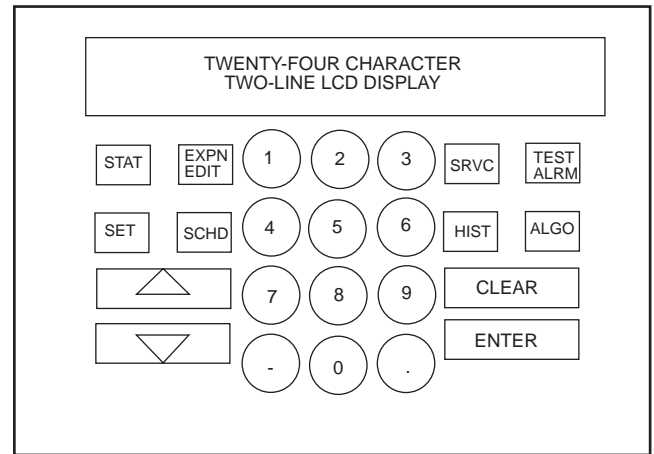
**NOTE:** It is not necessary to use the  $\downarrow$   $\uparrow$  through every item in a subfunction. For example, if you wanted to read the oil pressure for the A1 compressor, press  $\boxed{3}$   $\boxed{\text{STAT}}$ , then press  $\boxed{7}$   $\downarrow$  to go directly to A1 Oil Pressure. Use a similar procedure to view an item near the bottom of a subfunction. To view the Circuit A Oil Switch status, press  $\boxed{4}$   $\boxed{\text{STAT}}$  and  $\boxed{3}$   $\uparrow$ . Use a similar procedure to view an item near the bottom of a subfunction. To view Condenser Pump Flow Switch status, press  $\boxed{8}$   $\boxed{\text{STAT}}$ ,  $\uparrow$ , and  $\boxed{8}$   $\uparrow$ . This procedure is available in all functions except the TEST function.

**AUTOMATIC DEFAULT DISPLAY** — When the keypad has not been used for 10 minutes, the display automatically switches to the rotating automatic default display. This display contains the 5 parts shown below.

Entering Fluid Temp  
xx.x° F

Leaving Fluid Temp  
xx.x° F  
Percent Total Capacity  
xxx.x%  
Total Number of Alarms  
xx  
MODES : MODE\_TBL  
Current active modes

All functions are made up of a group of subfunctions. To enter a subfunction, first press the subfunction number desired. Then press the function key in which the subfunction resides. To move within that subfunction, press the up or down arrow keys. Another subfunction may be entered at any time by pressing the subfunction number, then the function key. Depending on system type and configuration, all displays may not be shown.



LEGEND

LCD — Liquid Crystal Display

Fig. 7 — Keypad and Display Module

Table 7 — Keypad and Display Module Usage

FUNCTION KEYS	USE
$\boxed{\text{STAT}}$	STATUS — For displaying diagnostic codes and current operating information about the machine.
$\boxed{\text{HIST}}$	HISTORY — For displaying run time, cycles, and previous alarms.
$\boxed{\text{SERV}}$	SERVICE — For entering specific unit configuration information and enabling manual control function.
$\boxed{\text{SCHED}}$	SCHEDULE — For entering occupied/unoccupied schedules for unit operation.
$\boxed{\text{ALGO}}$	ALGORITHM — Not used.
$\boxed{\text{SET}}$	SET POINT — For entering operating set points and day/time information.
$\boxed{\text{TEST ALRM}}$	TEST — For testing operating of the analog and discrete outputs.
OPERATIVE KEYS	USE
$\boxed{\text{EXPN EDIT}}$	EXPAND — For displaying a non-abbreviated expansion of the display.
$\boxed{\text{CLR}}$	CLEAR — For clearing the screen of all displays.
$\uparrow$	UP ARROW — For returning to previous display position.
$\downarrow$	DOWN ARROW — For advancing to next display position.
$\boxed{\text{ENTR}}$	ENTER — For entering data.

**Table 8A — HSIO Functions and Subfunctions**

SUBFUNCTION NO.	FUNCTIONS					
	Status	Test	Schedule	Service	History	Set Point
	STAT	TEST	SCHD	SRVC	HIST	SET
1	Alarm Display	Circuit A Discrete Outputs	Ice Build Occupancy Schedule	Factory Configuration	Operating Hours	Set Points
2	General Parameters Display	Circuit B Discrete Outputs	Local/Normal Occupancy Schedule	Options Configuration 1	Alarm History	English/Metric
3	Circuit A Analog Values	Unit Discrete Outputs	Remote CCN Occupancy Schedule	Options Configuration 2	—	Bus Address
4	Circuit A Discrete Inputs/Outputs Table	Valves and Motormaster® Control	Holiday 01 Configuration	Reset/Demand Limit Configuration	—	Time/Date Configuration
5	Circuit B Analog Values	—	Holiday 02 Configuration	Machine Configuration Codes	—	CCN Enable/Disable
6	Circuit B Discrete Inputs/Outputs Table	—	Holiday 03 Configuration	—	—	—
7	Unit Analog Parameters	—	Holiday 04 Configuration	Transducer Calibration	—	—
8	Miscellaneous Inputs/Outputs	—	Holiday 05 Configuration	Manual Control	—	—
9	Operating Modes	—	Holiday 06 Configuration	Master/Slave Configuration	—	—
10	Capacity Control	—	Holiday 07 Configuration	—	—	—
11	Dual Chiller	—	Holiday 08 Configuration*	—	—	—

\*Subfunctions  1  2 through  3  3  SCHD are for configuring Holidays 09 through 30.

**Table 8B — Functions and Subfunctions Cross-Reference for the Optional LID-2B Controller**

The optional LID-2B controller cross reference table below can be used as a guide to access the same information outlined in the HSIO functions and subfunctions table (see Table 8A). For example, in Table 8A, the alarm history is accessed through the HSIO by pressing 2 and the History button on the keypad (see Table 7). The LID-2B cross

reference table lists the menu item from the LID-2B which contains the alarm history information. In another example, from Table 8A, pressing 3 and the Status button on the HSIO keypad will access the circuit A analog values. In the table below, the circuit A analog values are accessed by selecting STATUS CIRCA\_AN from the appropriate LID-2B menu.

HSIO SUBFUNCTION NO.	HSIO FUNCTION KEY					
	Status <input type="button" value="STAT"/>	Test <input type="button" value="TEST"/>	Schedule <input type="button" value="SCHD"/>	Service <input type="button" value="SRVC"/>	History <input type="button" value="HIST"/>	Set Point <input type="button" value="SET"/>
1	STATUS A_UNIT_1	SERVICE CONTROL TEST	SCHEDULE OCCPC012	SERVICE EQUIPMENT CONFIGURATION	SERVICE EQUIPMENT CONFIGURATION STRTHOUR	SETPOINT
2	STATUS A_UNIT_1	SERVICE CONTROL TEST	SCHEDULE OCCPC02S	SERVICE EQUIPMENT CONFIGURATION OPTIONS1	SERVICE ALARM HISTORY	SERVICE LID CONFIGURATION
3	STATUS CIRCA_AN	SERVICE CONTROL TEST	SCHEDULE OCCPC65S	SERVICE EQUIPMENT CONFIGURATION OPTIONS2	—	SERVICE CONTROLLER IDENTIFICATION
4	STATUS CIRA_DIO	SERVICE CONTROL TEST	SERVICE EQUIPMENT CONFIGURATION HOLIDAY,HOLDY_01	SERVICE EQUIPMENT CONFIGURATION RESETCON	—	SERVICE TIME AND DATE
5	STATUS CIRCB_AN	—	SERVICE EQUIPMENT CONFIGURATION HOLIDAY,HOLDY_02	SERVICE EQUIPMENT CONFIGURATION CONCODES	—	STATUS A_UNIT_1
6	STATUS CIRB_DIO	—	SERVICE EQUIPMENT CONFIGURATION HOLIDAY,HOLDY_03	—	—	—
7	STATUS UNIT_2	—	SERVICE EQUIPMENT CONFIGURATION HOLIDAY,HOLDY_04	SERVICE EQUIPMENT SERVICE CALIBRTE	—	—
8	STATUS UNIT_3	—	SERVICE EQUIPMENT CONFIGURATION HOLIDAY,HOLDY_05	SERVICE EQUIPMENT SERVICE MAN_CTRL	—	—
9	STATUS MODE_TBL	—	SERVICE EQUIPMENT CONFIGURATION HOLIDAY,HOLDY_06	SERVICE EQUIPMENT CONFIGURATION MSTR_SLV	—	—
10	SERVICE CONTROL ALGORITHM STATUS LOADFACT	—	SERVICE EQUIPMENT CONFIGURATION HOLIDAY,HOLDY_07	—	—	—
11	SERVICE CONTROL ALGORITHM STATUS LEADLAG	—	SERVICE EQUIPMENT CONFIGURATION HOLIDAY,HOLDY_08*	—	—	—

\*Subfunctions   through    are for configuring Holidays 09 through 30, and are also found under Service, Equipment Configuration.

NOTE: The optional LID-2B controller uses the same password (1111) as the HSIO.

**Table 9 — Accessing Functions and Subfunctions**

OPERATION	KEYPAD ENTRY	DISPLAY RESPONSE
To access a function, press subfunction no. and function name key. Display shows subfunction group.	<b>1</b> <b>TEST</b>	Circuit A Discrete Outputs Loader A1 Relay is OFF
To move to other elements, scroll up or down using arrow keys.	↓ ↓ ↓ ↓ ↓ ↓ ↓ ↓	Loader A2 Relay is OFF Minimum Load Valve A Relay is OFF Circuit A Oil Heater Relay is OFF A1 Mtr. Cooling Solenoid Relay is OFF A2 Mtr. Cooling Solenoid Relay is OFF Circuit A Oil Pump Relay is OFF Oil Solenoid A1 Relay is OFF Oil Solenoid A2 Relay is OFF
When the last element in a subfunction has been displayed, the first element is repeated.	↓	Loader A1 Relay is OFF
To move to next subfunction it is not necessary to use subfunction number. Press function name key to advance display through all subfunctions within a function and then back to the first.	<b>TEST</b> <b>TEST</b> <b>TEST</b> <b>TEST</b>	Circuit B Discrete Outputs Loader B1 Relay is OFF Unit Discrete Outputs Valves and Motor Master Circuit A Discrete Outputs
To move to another function, either depress function name key for desired function (display shows the first subfunction), or Access a specific subfunction by using the subfunction number and the function name key.	<b>STAT</b> <b>4</b> <b>STAT</b>	Alarms : xx Reset Alarms : 1 <ENTER> CIR. A DISCRETE OUTPUTS

**STATUS FUNCTION** — This function shows the rotating display, current status of alarm and alert (diagnostic) codes, capacity stages, operating modes, chilled water set point, all measured system temperatures and pressures, analog inputs, and switch inputs. Refer to Table 10 for a complete description of the function.

**Alarms/Alerts** — Alarms and alerts are messages that one or more faults have been detected. The alarms and alerts indicate failures that cause the unit to shut down, terminate an option (such as reset) or result in the use of a default value such as a set point. Refer to the Troubleshooting section for more information.

Up to 10 alarms/alerts can be stored at once. To view them, press **1** **STAT**. The control will display the current total number of alarms/alerts. Use the arrow keys to scroll through the list. Press the **EXPN** key when needed to view the full description of an alarm or alert. Press **1** **ENTR** to clear all the alarms. See Table 11.

**IMPORTANT:** Do not clear the alarms without first reviewing the full list and investigating and correcting the cause of the alarms.

When an alarm or alert is stored in the display and the machine automatically resets, the alarm/alert is deleted. Codes

for safeties which do not automatically reset are not deleted until the problem is corrected and the machine is reset. To clear manual reset alarms from the CPM modules, the reset button on the HSIO bracket must be pressed. Next, switch the LOR switch to OFF and back to Local or Remote position (default alarm clearing method). Press **1** **STAT** and then **1** **ENTR** to clear the alarm from the PSIO if the default LOR reset function has been disabled.

**General Parameters** — General operating parameters are displayed including control mode, run status, CCN status, and the 5 most current alarms. Press **2** **STAT** to display these and the other values as shown in Table 10.

**Circuit A and B Analog and Discrete Information** — Circuit A Analog Values can be viewed by pressing **3** **STAT** and scrolling down to see current system operating conditions such as pressures and temperatures. Pressing **4** **STAT** will bring up Circuit A Discrete Inputs and Outputs. Scroll down to view the On/Off status of the compressor(s), loaders, solenoids, and pumps. Oil switch and feedback inputs are also displayed. Press **5** **STAT** and **6** **STAT** to view the identical analog values and discrete inputs and outputs for Circuit B. See Table 10 for a complete display.



Unit Analog Parameters and Temperature Reset — Press

and scroll down to display the unit entering and leaving fluid temperatures as well as the temperature reset signal and calculated values.

Miscellaneous Inputs and Outputs — Pressing   and scrolling down will reveal the On/Off status of the condenser fans (30GX only). Also found here are the Demand Limit settings, pump relay and switch status, and miscellaneous items such as Heat/Cool and Dual Set Point switch positions. See Table 10 for a complete list.

Modes — The operating modes are displayed to indicate the operating status of the unit at a given time. See Table 12 for a complete list of all modes.

To enter the MODES subfunction, press   and use the  key to view all current modes of operation. See Table 13.

Capacity Control — Pressing   , this subfunction displays the load/unload factor, control point, and leaving water temperature. Scrolling down will also reveal the liquid level sensor values in degrees format.




































Dual Chiller — Pressing    will access the dual chiller control status. This subfunction will display whether or not the chiller is operating as a Master or Slave, any alarm conditions present for dual chiller control, and lead/lag information for changeover. Dual chiller control is configured under  .

Table 10 — Status Function and Subfunction Directory




































SUBFUNCTION	KEYPAD ENTRY	DISPLAY	COMMENT
1 Alarms	[1] [STAT]	Alarm : xx Reset Alarms: 1 <ENTER>	Use [EXPN] as needed
	[↓]	All current alarms are displayed	
2 General Parameters	[2] [STAT]	GENERAL PARAMETERS	Displays LOCAL ON/OFF or CCN ON/OFF  Force/clear value with HSIO or CCN device. Must be ON for CCN clock control.
	[↓]	Control Mode	
	[↓]	Run Status Off/On	
	[↓]	Occupied ? Yes/No	
	[↓]	CCN Enable Off/On	
	[↓]	CCN Chiller Start/Stop Start/Stop	
	[↓]	Alarm State Normal/Alarm	
	[↓]	Current Alarm 1 x.xx	
	[↓]	Current Alarm 2 x.xx	
	[↓]	Current Alarm 3 x.xx	
	[↓]	Current Alarm 4 x.xx	
	[↓]	Current Alarm 5 x.xx	
	[↓]	Active Demand Limit xxx.x%	
	[↓]	Percent Total Capacity xxx.x%	
	[↓]	Water/Brine Setpoint xx.x dF	
	[↓]	Control Point xx.x dF	
	[↓]	Entering Fluid Temperature xx.x dF	
	[↓]	Leaving Fluid Temperature xx.x dF	
[↓]	Emergency Stop Emstop		
[↓]	Minutes Left for Start xx min		
[↓]	Heat-Cool Status Heat/Cool		
3 Circuit A Analog Values	[3] [STAT]	CIRCUIT A ANALOG VALUES	Percentage of total circuit capacity currently in use. Percentage of Total Capacity value not in an alarm or fault condition.
	[↓]	Total Capacity xxx.x%	
	[↓]	Available Capacity xxx.x%	
	[↓]	Discharge Pressure xxx.x PSI	
	[↓]	Suction Pressure xxx.x PSI	
	[↓]	A1 Oil Pressure Diff. xxx.x PSI	
	[↓]	A2 Oil Pressure Diff. xxx.x PSI	
	[↓]	A1 Oil Pressure xxx.x PSI	
	[↓]	A2 Oil Pressure xxx.x PSI	
	[↓]	Discharge Gas Temperature xxx.x dF	
	[↓]	A1 Motor Temperature xxx.x dF	
	[↓]	A2 Motor Temperature xxx.x dF	

See Legend on page 23.

**Table 10 — Status Function and Subfunction Directory (cont)**

SUBFUNCTION	KEYPAD ENTRY	DISPLAY	COMMENT
<b>3 Circuit A Analog Valves (cont)</b>	<div style="text-align: center;">                  </div>	SAT Condensing Temp xxx.x dF Saturated Suction Temp xxx.x dF EXV Percent Open xxx.x% Motormaster Speed xxx.x% Water Valve Position xxx.x% Cooler Level Indicator x.xx CPM A1 Feedback x.x Volts CPM A2 Feedback x.x Volts Circuit A Econ Pressure xxx.x PSI	      See Table 3.  See Table 3.
<b>4 Circuit A Discrete Inputs/Outputs</b>	<div style="text-align: center;">                                </div>	CIR. A DISCRETE OUTPUTS  Compressor A1 Off/On Compressor A2 Off/On Loader A1 Off/On Loader A2 Off/On Minimum Load Valve A Off/On Circuit A Oil Heater Off/On A1 Mtr Cooling Solenoid Off/On A2 Mtr Cooling Solenoid Off/On Circuit A Oil Pump Off/On Oil Solenoid A1 Off/On Oil Solenoid A2 Off/On CIR. A DISCRETE INPUTS  Circuit A Oil Switch Open/Close Compressor A1 Feedback Off/On Compressor A2 Feedback Off/On	
<b>5 Circuit B Analog Values</b>	<div style="text-align: center;">                    </div>	CIRCUIT B ANALOG VALUES  Total Capacity xxx.x% Available Capacity xxx.x% Discharge Pressure xxx.x PSI Suction Pressure xxx.x PSI B1 Oil Pressure Diff. xxx.x PSI B2 Oil Pressure Diff. xxx.x PSI B1 Oil Pressure xxx.x PSI B2 Oil Pressure xxx.x PSI Discharge Gas Temperature xxx.x dF	Percentage of total circuit capacity currently in use. Percentage of Total Capacity value not in an alarm or fault condition.

**Table 10 — Status Function and Subfunction Directory (cont)**

































SUBFUNCTION	KEYPAD ENTRY	DISPLAY	COMMENT
5 Circuit B Analog Valves (cont)	          	B1 Motor Temperature xxx.x dF B2 Motor Temperature xxx.x dF SAT Condensing Temp xxx.x dF Saturated Suction Temp xxx.x dF EXV Percent Open xxx.x% Motormaster Speed xxx.x% Water Valve Position xxx.x% Cooler Level Indicator x.xx CPM B1 Feedback x.x Volts CPM B2 Feedback x.x Volts Circuit B Econ Pressure xxx.x PSI	See Table 3.  See Table 3.
6 Circuit B Discrete Inputs/Outputs	               	CIR. B DISCRETE OUTPUTS  Compressor B1 Off/On Compressor B2 Off/On Loader B1 Off/On Loader B2 Off/On Minimum Load Valve B Off/On Circuit B Oil Heater Off/On B1 Mtr Cooling Solenoid Off/On B2 Mtr Cooling Solenoid Off/On Circuit B Oil Pump Off/On Oil Solenoid B1 Off/On Oil Solenoid B2 Off/On CIR. B DISCRETE INPUTS  Circuit B Oil Switch Open/Close Compressor B1 Feedback Off/On Compressor B2 Feedback Off/On	
7 Unit Analog Parameters	       	UNIT ANALOG PARAMETERS  Cooler Entering Fluid xx.x dF Cooler Leaving Fluid xx.x dF Condenser Entering Fluid xx.x dF Condenser Leaving Fluid xx.x dF Reclaim Entering Fluid xx.x dF Reclaim Leaving Fluid xx.x dF 5 Volt Supply x.x Volts	

See Legend on page 23.

Table 10 — Status Function and Subfunction Directory (cont)

SUBFUNCTION	KEYPAD ENTRY	DISPLAY	COMMENT
7 Unit Analog Parameters (cont)	↓	TEMPERATURE RESET	
	↓	4-20 mA Reset Signal xx.x mA	
	↓	Return Reset Signal xx.x dF	
	↓	External Reset Signal xx.x dF	
	↓	Outdoor Air Temp xx.x dF	
	↓	Calculated Reset xx.x dF	
8 Misc. Inputs/Outputs	8 <span style="border: 1px solid black; padding: 0 2px;">STAT</span>	MISC INPUTS/OUTPUTS	
	↓	FAN_1 Off/On	
	↓	FAN_2 Off/On	
	↓	FAN_3 Off/On	
	↓	FAN_4 Off/On	
	↓	FAN_5 Off/On	
	↓	FAN_6 Off/On	
	↓	DEMAND LIMIT	
	↓	4-20 mA Demand Signal xx.x mA	
	↓	Demand Switch 1 Off/On	
	↓	Demand Switch 2 Off/On	
	↓	CCN Loadshed Signal Normal/Alarm	
	↓	Max Allowable CAP xxx.x%	
	↓	PUMPS	
	↓	Cooler Pump Relay Off/On	
	↓	Cooler Pump Flow Switch Off/On	
	↓	Condenser Pump Relay Off/On	
	↓	Condenser Pump Flow Switch Off/On	
	↓	MISCELLANEOUS	
	↓	Ice Valve Off/On	
	↓	Ice Build Complete Yes/No	
	↓	Heat/Cool Switch Heat/Cool	
	↓	Dual Set point Switch Off/On	
↓	Cooler Heater Off/On		
↓	Options Temperature 1 xx.x dF	Not Used	
↓	Options Temperature 2 xx.x dF	Not Used	
9 Operating Modes	9 <span style="border: 1px solid black; padding: 0 2px;">STAT</span>	MODES :MODE_TBL mode name ON/OFF	Only active modes displayed
	↓	LOCAL OFF	Scroll with down arrow key to display
	↓	CCN OFF	

**Table 10 — Status Function and Subfunction Directory (cont)**

SUBFUNCTION	KEYPAD ENTRY	DISPLAY	COMMENT
<b>9 Operating Modes (cont)</b>		CLOCK OFF	
		LOCAL ON	
		CCN ON	
		CLOCK ON	
		DUAL SP ACTIVE (1st SP)	
		DUAL SP ACTIVE (2nd SP)	
		TEMPERATURE RESET ACTIVE	
		DEMAND LIMIT ACTIVE	
		LOAD LIMIT ACTIVE	
		LOW SOURCE TEMP PROTECT	
		RAMP LOADING ACTIVE	
		TIMED OVERRIDE ACTIVE	
		LOW COOLER SUCTION TEMP	
		WSM CONTROLLING	
		SLOW CHANGE OVERRIDE	
		OFF TO ON DELAY ACTIVE	
		FSM CONTROLLING	
		2 CHILLR LEAD LAG ACTIVE	
		2 CHILLR LL COMM FAILURE	
		CIR A LOW DISCHG SUPERHT	
	CIR B LOW DISCHG SUPERHT		
	CIR A HIGH SDT		
	CIR B HIGH SDT		
<b>10 Capacity Control</b>	  	CAPACITY CONTROL	
		Load/Unload Factor xxx.x%	
		Control Point xx.x dF	
		Leaving Water Temp xx.x dF	
		MISC. INDICATORS	
		Liquid Lvl Sensor Cir. A xx.x dF	
		Liquid Lvl Sensor Cir. B xx.x dF	

**Table 10 — Status Function and Subfunction Directory (cont)**

SUBFUNCTION	KEYPAD ENTRY	DISPLAY	COMMENT
11 Dual Chiller	1 1 STAT	DUAL CHILLER	
	↓	Unit Master / Slave 0 / 1 / 2	0 = Neither 1 = Slave 2 = Slave
	↓	Master / Slave Ctrl Active Yes / No	
	↓	Lead Chiller 1 / 2	1 = Master 2 = Slave
	↓	Slave Chiller State 0 / 1 / 3 / 5 / 6	0 = Chiller OFF 1 = Valid Run State in CCN Mode 3 = Chiller in Local Mode 5 = Shutdown on Alarm 6 = Communications Failure
	↓	Slave Chiller Total Cap xxx.x%	
	↓	Lead / Lag Changeover	Yes if Lead / Lag Balance Enabled
	↓	Master / Slave Error 1 / 2 / 3 / 4 / 5 / 6	1 = Master / Slave Have Same Address 2 = Master / Slave Communication Failure 3 = Chiller in Local Mode 4 = Slave Shutdown on Alarm(s) 5 = Master Configured for Heating 6 = No Slave Configured

**LEGEND**

- CCN** — Carrier Comfort Network
- CPM** — Compressor Protection Module
- dF** — Degrees Fahrenheit
- EXV** — Electronic Expansion Valve
- FSM** — Flotronic™ System Manager
- LL** — Lead/Lag
- SAT** — Saturated
- SDT** — Saturated Discharge Temperature
- SP** — Set Point
- WSM** — Water System Manager

**Table 11 — Reading and Clearing Alarms**

KEYPAD ENTRY	DISPLAY	COMMENT
1 STAT	Alarm: 02 Reset Alarms: 1 <ENTER>	
↓	Comp A1 Fail - 1.70 Volt Alarm : 15:12 04/15/96	
EXPN	Comp A1 Fail - 1.70 Volts Phase Reversal Alarm : 15:12 04/15/96	
↓	Compressor A1 Low Oil Pr Alarm : 10:34 04/15/96	
EXPN	Compressor A1 Low Oil Pressure Alarm : 10:34 04/15/96	
↓	Alarm: 02 Reset Alarms: 1 <ENTER>	Press Reset button first
1 ENTR	Alarm: 00 Reset Alarms: 1 <ENTER>	Alarms reset and cleared
0 STAT	Entering Fluid Temp xx.x dF Leaving Fluid Temp xx.x dF Percent Total Capacity xxx.x% Total Number of Alarms xx MODES: MODE__TBL List of All Current Modes	Returns to rotating default display

**Table 12 — Operational and Mode Display Codes**

CODE	DESCRIPTION
<b>LOCAL OFF</b>	Unit is off. LOCAL/OFF/REMOTE switch is in OFF position or LOCAL/OFF/REMOTE switch is in REMOTE position and remote contacts are open.
<b>CCN OFF</b>	Unit is off. LOCAL/OFF/REMOTE switch is in LOCAL position and CCN control is enabled (Stop state) or CCN is enabled (Stop state) with LOR switch in REMOTE position and remote contacts closed.
<b>CLOCK OFF</b>	Unit is off due to internal clock schedule. LOR switch is in LOCAL position.
<b>LOCAL ON</b>	Unit is on. LOR switch is in LOCAL position and CCN is disabled or LOR switch is in REMOTE position with contacts closed and CCN is disabled.
<b>CCN ON</b>	Unit is on due to CCN command. LOR switch is in LOCAL position and CCN is enabled (Run state) or LOR switch is in REMOTE position with contacts closed and CCN is enabled (Run state)
<b>CLOCK ON</b>	Unit is on due to internal clock schedule or occupied override function. LOR switch is in LOCAL position.
<b>DUAL SP ACTIVE (1st SP)</b>	Dual set point is in effect. In this mode, unit continues to run in an occupied condition, and leaving fluid set point is automatically controlled to the CSP1 set point in the SET POINT function.
<b>DUAL SP ACTIVE (2nd SP)</b>	Dual set point is in effect. In this mode, unit continues to run in unoccupied condition, but leaving fluid set point is automatically increased to a higher level (CSP2 set point is in SET POINT function).
<b>TEMPERATURE RESET ACTIVE</b>	Temperature reset is in effect. In this mode, unit is using temperature reset to adjust leaving fluid set point upward, and unit is currently controlling to the modified set point. The set point can be modified based on return fluid, outdoor-air temperature, space temperature, or 4 to 20 mA signal.*
<b>DEMAND LIMIT ACTIVE</b>	Demand limit is in effect. This indicates that capacity of unit is being limited by demand limit control option. Because of this limitation, the unit may not be able to produce the desired leaving fluid temperature. Demand limit can be controlled by a switch or 4 to 20 mA signal.*
<b>FSM CONTROLLING</b>	Flotronic™ System Manager (FSM) is controlling the chiller.
<b>RAMP LOADING ACTIVE</b>	Ramp load (pulldown) limiting is in effect. In this mode, the rate at which leaving fluid temperature is dropped is limited to a predetermined value to prevent compressor overloading. See CRAMP set point in the SET function in (page 25). The pulldown limit can be modified, if desired, to any rate from 0.2° F to 2° F (0.1° to 1° C)/minute.
<b>TIMED OVERRIDE ACTIVE</b>	Timed override is in effect. This is a 1 to 4 hour temporary override of the programmed schedule, forcing unit to occupied mode. Override can be implemented with unit under LOCAL/REMOTE or CCN control. Override expires after each use.
<b>WSM CONTROLLING</b>	Water System Manager is controlling the chiller.
<b>SLOW CHANGE OVERRIDE</b>	Slow change override is in effect. The leaving fluid temperature is close to and moving towards the control point.

CODE	DESCRIPTION
<b>OFF TO ON DELAY ACTIVE</b>	Chiller is being held off by Minutes Off Time found by keying <b>1</b> <b>SET</b> . Also, normal operation of the chiller includes a minimum 1.5 minute delay after a capacity stage change has been made. This delay is adjustable from 1.5 to 6 minutes.
<b>LOAD LIMIT ACTIVE</b>	This function determines the maximum allowable capacity that can be running and is accomplished through the Flotronic System Manager. The unit may not be able to produce the desired leaving fluid temperature.
<b>2 CHILLR LEAD LAG ACTIVE</b>	Future Use.
<b>2 CHILLR LL COMM FAILURE</b>	Future Use.
<b>CIRCUIT A LOW DISCHARGE SUPERHT</b>	If the circuit discharge superheat is less than 15° F (8.3° C), the capacity control routine will not add any stages (to either circuit).  If the compressor has been running for at least 3 minutes, the EXV will not be opened any further. If the circuit discharge superheat is less than 10° F (5.6° C) and falling, the circuit EXV will be closed 50 steps every 10 seconds.  If the discharge superheat is less than 5° F (2.8° C) and falling, a circuit loader will be deenergized every 30 seconds. The final stage will not be unloaded unless an alarm condition is present.
<b>CIRCUIT B LOW DISCHARGE SUPERHT</b>	See description for Circuit A above.
<b>CIRCUIT A HIGH SCT</b>	If the circuit is running and the Saturated Condensing Temperature (SCT) is greater than the Maximum Condensing Temperature Set point (MCT_SP) minus 12° F (6.7° C), the control will not add any stages.  If the SCT is greater than the MCT_SP plus 5° F (2.8° C), the circuit will be unloaded and shut down if necessary. If the SCT is greater than the MCT_SP plus 2° F (1.1° C) for one minute, a loader will be deenergized.  If the SCT is greater than the MCT_SP minus 4° F (2.2° C), the control will compare the maximum operating pressure set point (MOP_SP) with the modified MOP_SP (MOP_CTRL).  If the MOP_CTRL is greater than the MOP_SP, the mode will be cleared. Otherwise the control will display the high SCT override mode. The capacity control routine will not add any stages. If the circuit is at its lowest capacity, this mode will be ignored.
<b>CIRCUIT B HIGH SCT</b>	See description for Circuit A above.

**LEGEND**

- CCN** — Carrier Comfort Network
- CSP** — Cooling Set Point
- CRAMP** — Cooling Ramp Loading
- EXV** — Electronic Expansion Valve
- LOR** — Local/Off/Remote
- SP** — Set Point
- WSM** — Water System Manager

\*A field-supplied 500 Ohm ½ W resistor must be installed across the input terminals when using a 4 to 20 mA signal.

**Table 13 — Reading Current Operating Modes**

KEYPAD ENTRY	DISPLAY
<b>9</b> <b>STAT</b>	MODES :MODE_TBL CCN ON
<b>↓</b>	DEMAND LIMIT ACTIVE



**TEST FUNCTION** — The test function operates the diagnostic program. To initiate the test function, the LOCAL/OFF/REMOTE switch must be in the OFF position.

To reach a particular test, press its subfunction number followed by the **ENTR** key then scroll to the desired test by pressing the down arrow key. Refer to Table 14 for a complete description of the test function.

To start a test of discrete outputs, press **1** **ENTR**. To end the test, simply press the **↓** key or press **0** **ENTR**. Pressing the **↓** key after a test has started advances the system to the next test, whether the current test is operating or has timed out. Circuit A discrete outputs can be tested in **1** **TEST** and include loaders, minimum load valve, oil heater (if equipped), motor cooling solenoids, oil pump, and oil solenoids. Similarly, Circuit B discrete outputs can be tested in **2** **TEST**. Additional discrete outputs, including condenser fans, cooler heater, water pumps, and remote alarms can be tested in **3** **TEST**.

Press **4** **TEST** to access Valves and Motormaster® device analog outputs. Scroll down to display Circuit A EXV Valve with a target percent of 0%. Press **1** **ENTR** to step the EXV to 25%. Pressing **1** **ENTR** three additional times will move the EXV to 50%, 75%, and 100%. The EXV may be closed in 25% steps by pressing **0** **ENTR** for each desired step. Wait 30 seconds between each step when opening and closing for the valve to stop moving. Pressing the down arrow will display Circuit B EXV Valve and it is tested in the same manner as Circuit A. Also available for test are Circuit A water valve (if equipped) and the Circuit A and B Fan speed % (direct control Motormaster device) outputs for 30GX chillers. These are tested in the same manner as the EXV valves. Note that condenser fan motors are NOT started during fan speed quick tests. Measure 4 to 20 mA dc output using meter in series with violet wire to controller. See page 72 of Field Wiring section.

While the unit is in test, you can leave the test function and access another display or function by pressing the appropriate keys. However, a component that is operating when another function is accessed remains operating. You must re-enter the test function and press **0** **ENTR** to shut down the component. Components with a timed operating limit time out normally even if another function is accessed.

Since the Test function checks only certain outputs, it is a good practice to also check all inputs and outputs accessible through the status function. These can be located by pressing **3** through **8** **STAT**. If keypad is not used for 10 minutes, the unit automatically leaves the test function and resumes the normal rotating display. See Table 15.

**HISTORY FUNCTION** — Pressing **1** **HIST** displays total machine operating hours. Scroll down to display machine run time and starts, and total run time and starts for each compressor. Refer to Table 16 for a complete description of the function. When the PSIO-1 module is replaced or downloaded with Version 4.0 or later software, the number of starts and run hours may be changed one time. Record the current values from the PSIO before removing the module or downloading new software. The number of starts and hours may be changed by entering the desired value at the HSIO and pressing the **ENTR** key.

Pressing **2** **HIST** displays the last 10 alarms along with a description and time and date of occurrence of each alarm.

**SET POINT FUNCTION** — Set points are entered through the keypad. Set points can be changed within the upper and lower limits, which are fixed. The ranges are listed below. Refer to Table 17 for a complete description of the function.

Cooling Set Point 1,2

Water:	Medium Temperature Brine:	Low Temperature Brine:
38 to 70 F (3.3 to 21.1 C)	14 to 70 F (-10 to 21.1 C)	-13 to 70 F (-25 to 21.1 C)

Reset Set Points

Maximum Reset Range: -30 to 30 F (-17 to 17 C)	External Temperature Reset: -40 to 240 F (-40 to 118 C)	Chiller Fluid Δ: 0° to 15 F (0° to 8 C)
External Signal Reset: 4 to 20 mA (2-10 vdc with 500 Ohm resistor)		

Demand Limit Set Points

Switch Input:	Step 1 — 0 to 100% Capacity Reduction Step 2 — 0 to 100% Capacity Reduction
External Signal:	Maximum Demand Limit 4 to 20 mA (2-10 vdc with 500 Ohm resistor) Minimum Demand Limit 4 to 20 mA (2-10 vdc with 500 Ohm resistor)
Loadshed Demand Delta: 0 to 60%	
Maximum Loadshed Time: 0 to 120 min.	

Head Pressure Set Points

Air cooled chillers (30GX):	80 to 135 F (26.7 to 57.2 C)
Water cooled chillers (30HX):	80 to 128 F (26.7 to 53.3 C)

Set Point Table — The unit operating set points can be found

under **1** **SET**. Use the down arrow key to scroll through the set points. The first set point is Cool Set Point 1. This is the occupied chilled fluid set point. Scroll down to Cool Set Point 2 and then to the Cooling Ramp load multiplier which is configurable from 0.2 to 2.0° F/min. (0.11 to 1.1° C/min.). This value is the maximum rate at which the leaving fluid temperature is allowed to drop without adding a stage. Cooling Set Point 2 is used in conjunction with the dual set point switch function. This is used as the low temperature set point for ice duty or as the unoccupied set point. Press the down arrow key to display the Circuit A and B head pressure set points. The remaining set points in this subfunction include demand limit, LCW (leaving chilled water) delta alarm limit, minutes off time, and motor temperature set point.

Display Units — Press **2** **SET** to display the units of measure being used. Type 0 is for English and type 1 is for Metric.

Address — For CCN configurations, press **3** **SET** and scroll down to display the address and bus number of the chiller.

Time — Press **4** **SET** and scroll down to read and change the unit day of week, time, day of month, month of year and year of century. See the examples in Table 17 for making changes to these values.

CCN Enable/Disable — Press **5** **SET** to disable the CCN control of the chiller. This function will override CCN control commands. The CCN Enable value under **2** **STAT** must be ON to activate this function. With CCN Enable set to ON and Disable CCN Control set to “0,” the chiller will function normally under CCN control. With Disable CCN Control set to “1,” the chiller will operate in a local mode under its own control.

Reading and Changing Set Points — Table 18 shows how to read and change the chilled fluid set point. Other set points can be changed by following the same procedure. Refer to Table 17 for the sequence of display of set points in each subfunction.

**Table 14 —Test Function and Subfunction Directory**

SUBFUNCTION	KEYPAD ENTRY	DISPLAY	COMMENT
<b>1 Circuit A Discrete Output</b>	<div style="display: flex; flex-direction: column; gap: 10px;"> <div style="display: flex; align-items: center;"> <div style="border: 1px solid black; padding: 2px 5px; margin-right: 5px;">1</div> <div style="border: 1px solid black; padding: 2px 5px; margin-right: 5px;">TEST</div> </div> <div style="display: flex; align-items: center;"> <div style="border: 1px solid black; padding: 2px 5px; margin-right: 5px;">1</div> <div style="border: 1px solid black; padding: 2px 5px; margin-right: 5px;">ENTR</div> </div> <div style="border: 1px solid black; padding: 2px 5px; text-align: center;">↓</div> <div style="border: 1px solid black; padding: 2px 5px; text-align: center;">↓</div> <div style="border: 1px solid black; padding: 2px 5px; text-align: center;">↓</div> <div style="border: 1px solid black; padding: 2px 5px; text-align: center;">↓</div> <div style="border: 1px solid black; padding: 2px 5px; text-align: center;">↓</div> <div style="border: 1px solid black; padding: 2px 5px; text-align: center;">↓</div> <div style="border: 1px solid black; padding: 2px 5px; text-align: center;">↓</div> <div style="border: 1px solid black; padding: 2px 5px; text-align: center;">↓</div> </div>	Circuit A Discrete Output Loader A1 Relay is OFF Loader A1 Relay is ON Loader A2 Minimum Load Valve A Circuit A Oil Heater A1 Mtr. Cooling Solenoid A2 Mtr. Cooling Solenoid Circuit A Oil Pump Oil Solenoid A1 Oil Solenoid A2	Similarly, use <span style="border: 1px solid black; padding: 2px 5px;">1</span> <span style="border: 1px solid black; padding: 2px 5px;">ENTR</span> to test remaining outputs. Press the down arrow key or <span style="border: 1px solid black; padding: 2px 5px;">0</span> <span style="border: 1px solid black; padding: 2px 5px;">ENTR</span> to turn an output off.  NOTE: Output will display Relay is ABSENT when not configured
<b>2 Circuit B Discrete Outputs</b>	<div style="display: flex; flex-direction: column; gap: 10px;"> <div style="display: flex; align-items: center;"> <div style="border: 1px solid black; padding: 2px 5px; margin-right: 5px;">2</div> <div style="border: 1px solid black; padding: 2px 5px; margin-right: 5px;">TEST</div> </div> <div style="display: flex; align-items: center;"> <div style="border: 1px solid black; padding: 2px 5px; margin-right: 5px;">1</div> <div style="border: 1px solid black; padding: 2px 5px; margin-right: 5px;">ENTR</div> </div> <div style="border: 1px solid black; padding: 2px 5px; text-align: center;">↓</div> <div style="border: 1px solid black; padding: 2px 5px; text-align: center;">↓</div> <div style="border: 1px solid black; padding: 2px 5px; text-align: center;">↓</div> <div style="border: 1px solid black; padding: 2px 5px; text-align: center;">↓</div> <div style="border: 1px solid black; padding: 2px 5px; text-align: center;">↓</div> <div style="border: 1px solid black; padding: 2px 5px; text-align: center;">↓</div> <div style="border: 1px solid black; padding: 2px 5px; text-align: center;">↓</div> <div style="border: 1px solid black; padding: 2px 5px; text-align: center;">↓</div> </div>	Circuit B Discrete Outputs Loader B1 Relay is OFF Loader B1 Relay is ON Loader B2 Minimum Load Valve B Circuit B Oil Heater B1 Mtr. Cooling Solenoid B2 Mtr. Cooling Solenoid Circuit B Oil Pump Oil Solenoid B1 Oil Solenoid B2	Similarly, use <span style="border: 1px solid black; padding: 2px 5px;">1</span> <span style="border: 1px solid black; padding: 2px 5px;">ENTR</span> to test remaining outputs. Press the down arrow key or <span style="border: 1px solid black; padding: 2px 5px;">0</span> <span style="border: 1px solid black; padding: 2px 5px;">ENTR</span> to turn the output off.  NOTE: Output will display Relay is ABSENT when not configured
<b>3 Unit Discrete Output</b>	<div style="display: flex; flex-direction: column; gap: 10px;"> <div style="display: flex; align-items: center;"> <div style="border: 1px solid black; padding: 2px 5px; margin-right: 5px;">3</div> <div style="border: 1px solid black; padding: 2px 5px; margin-right: 5px;">TEST</div> </div> <div style="display: flex; align-items: center;"> <div style="border: 1px solid black; padding: 2px 5px; margin-right: 5px;">1</div> <div style="border: 1px solid black; padding: 2px 5px; margin-right: 5px;">ENTR</div> </div> <div style="border: 1px solid black; padding: 2px 5px; text-align: center;">↓</div> <div style="border: 1px solid black; padding: 2px 5px; text-align: center;">↓</div> <div style="border: 1px solid black; padding: 2px 5px; text-align: center;">↓</div> <div style="border: 1px solid black; padding: 2px 5px; text-align: center;">↓</div> <div style="border: 1px solid black; padding: 2px 5px; text-align: center;">↓</div> <div style="border: 1px solid black; padding: 2px 5px; text-align: center;">↓</div> <div style="border: 1px solid black; padding: 2px 5px; text-align: center;">↓</div> <div style="border: 1px solid black; padding: 2px 5px; text-align: center;">↓</div> <div style="border: 1px solid black; padding: 2px 5px; text-align: center;">↓</div> </div>	Unit Discrete Output Fan 1 Relay is OFF Fan 1 Relay is ON Fan 2 Fan 3 Fan 4 Fan 5 Fan 6 Cooler Pump Condenser Pump Cooler Heater Alarm Remote Alarm 1	Similarly use <span style="border: 1px solid black; padding: 2px 5px;">1</span> <span style="border: 1px solid black; padding: 2px 5px;">ENTR</span> to test remaining outputs. Press the down arrow key or <span style="border: 1px solid black; padding: 2px 5px;">0</span> <span style="border: 1px solid black; padding: 2px 5px;">ENTR</span> to turn output off.  Energizes Circuit A fans for 30HXA units. Energizes Circuit B fans for 30HXA units.  Currently not supported.

**Table 14 — Test Function and Subfunction Directory (cont)**

SUBFUNCTION	KEYPAD ENTRY	DISPLAY	COMMENT
3 Unit Discrete Output (cont)	↓	Remote Alarm 2	Currently not supported.
	↓	Remote Alarm 3	Currently not supported.
	↓	Remote Alarm 4	Currently not supported.
	↓	Remote Alarm 5	Currently not supported.
	↓	Remote Alarm 6	Currently not supported.
	↓	Remote Alarm 7	Currently not supported.
	↓	Remote Alarm 8	Currently not supported.
	↓	Remote Alarm 9	Currently not supported.
	↓	Remote Alarm 10	Currently not supported.
	↓	Remote Alarm 11	Currently not supported.
	↓	Remote Alarm 12	Currently not supported.
	↓	Remote Alarm 13	Currently not supported.
	↓	Remote Alarm 14	Currently not supported.
	↓	Remote Alarm 15	Currently not supported.
	↓	Remote Alarm 16	Currently not supported.
	4 Valves and Motormaster	4 TEST	Valves and Motor Master Circuit A EXV Valve Target Percent = 0%
1 ENTR		Circuit A EXV Valve Target Percent = 25%	
1 ENTR		Circuit A EXV Valve Target Percent = 50%	
1 ENTR		Circuit A EXV Valve Target Percent = 75%	
1 ENTR		Circuit A EXV Valve Target Percent = 100%	
↓		Circuit B EXV Valve Target Percent = 0%	
↓		Circuit A Water Valve Target Percent = 0%	
↓		Circuit A% Fan Speed	
↓		Circuit B% Fan Speed	

LEGEND

EXV — Electronic Expansion Valve

**Table 15 — Using Test Function**

KEYPAD ENTRY	DISPLAY RESPONSE	COMMENTS
1 TEST	Circuit A Discrete Output Loader A1 Relay is OFF	Appears on screen momentarily, then will switch to Loader A1.
1 ENTR	Loader A1 Relay is ON	Compressor Loader A1 solenoid energized
0 ENTR	Loader A1 Relay is OFF	Compressor Loader A1 solenoid deenergized
4 TEST	Valves and Motor Master Circuit A EXV Valve Target Percent = 0%	Continue pressing 1 ENTR to step to 50%, 75%, and 100%.
1 ENTR	Circuit A EXV Valve Target Percent = 25%	
0 ENTR	Circuit A EXV Valve Target Percent = 0	Continue pressing 0 ENTR to step closed.

LEGEND

EXV — Electronic Expansion Valve

**Table 16 — History Function and Subfunction Directory**





























SUBFUNCTION	KEYPAD ENTRY	DISPLAY	COMMENT
<b>1 Operating Hours</b>		Machine Operating Hours xxx.x hours	Number of hours unit has at least 1 compressor running
		Machine Starts xxx	Number of unit starts from zero capacity
		Circuit A	
		Operating Hours xxx.x hours	These values may be changed once, when new software is down- loaded or when the PSIO-1 module is replaced (Version 4.0 and later).
		Compressor A1 Hours xxx.x hours	
		Compressor A2 Hours xxx.x hours	
		Starts	
		Compressor A1 Starts xxx	
		Compressor A2 Starts xxx	
		Circuit B	
		Operating Hours xxx.x hours	
		Compressor B1 Hours xxx.x hours	
		Compressor B2 Hours xxx.x hours	
		Starts	
		Compressor B1 Starts xxx	
	Compressor B2 Starts xxx		
<b>2 Alarm History</b>		Previous Alarm 1 - description Alarm description, time/day of occurrence	Lists 10 most recent alarms. Use  key when necessary
		Previous Alarm 2 - description Alarm description, time/day of occurrence	
		Previous Alarm 3 - description Alarm description, time/day of occurrence	
		Previous Alarm 4 - description Alarm description, time/day of occurrence	
		Previous Alarm 5 - description Alarm description, time/day of occurrence	
		Previous Alarm 6 - description Alarm description, time/day of occurrence	
		Previous Alarm 7 - description Alarm description, time/day of occurrence	
		Previous Alarm 8 - description Alarm description, time/day of occurrence	
		Previous Alarm 9 - description Alarm description, time/day of occurrence	
		Previous Alarm 10- description Alarm description, time/day of occurrence	
			

Table 17 — Set Point Function and Subfunction Directory

SUBFUNCTION	KEYPAD ENTRY	DISPLAY	COMMENT
<b>1 Set Point Table</b>	<b>1</b> <b>SET</b>	COOLING	
	↓	Cool Setpoint 1 xx.x dF	Default: 44.0
	↓	Cool Setpoint 2 xx.x dF	Default: 44.0
	↓	Cooling Ramp Loading xx.x dF	Default: 0.5
	↓	HEATING	NOT SUPPORTED
	↓	Heat Setpoint 1 xx.x dF	NOT SUPPORTED Default: 98.0
	↓	Heat Setpoint 2 xx.x dF	NOT SUPPORTED Default: 98.0
	↓	Heating Ramp Loading xx.x dF	NOT SUPPORTED Default: 0.5
	↓	HEAD PRESSURE	
	↓	Head Pressure Setpoint A xxx.x dF	Default: 113.0 (GX) 100.0 (HXA) 85.0 (HXC)
	↓	Head Pressure Setpoint B xxx.x dF	Default: 113.0 (GX) 100.0 (HXA) 85.0 (HXC)
	↓	DEMAND LIMIT	
	↓	Demand Switch 1 Setpoint xxx.x%	Default: 80.0%
	↓	Demand Switch 2 Setpoint xxx.x%	Default: 50.0%
	↓	LCW Delta Alarm Limit xxx.x dF	Default: 50.0 dF
	↓	Minutes Off Time xxx min	Default: 0 min
	↓	Motor Temp Set Point xxx.x dF	Default: 200.0 dF
<b>2 Units</b>	<b>2</b> <b>SET</b>	US IMPERIAL/METRIC 0	0 = English (Default) 1 = Metric
<b>3 Address</b>	<b>3</b> <b>SET</b>	TARGET ADDRESS x	Default: 1
	↓	TARGET BUS NUMBER x	Default: 0
<b>4 Time</b>	<b>4</b> <b>SET</b>	Day of Week Monday	Mon=1, Tues=2, etc.
	<b>3</b> <b>ENTR</b>	Day of Week Wednesday	Day of week set
	↓	TIME (HOUR:MIN) 00:00	Enter military format
	<b>1</b> <b>0</b> <b>.</b> <b>3</b> <b>0</b> <b>ENTR</b>	TIME (HOUR:MIN) 10:30	Time of day set
	↓	DAY OF MONTH xx	
	<b>2</b> <b>0</b> <b>ENTR</b>	DAY OF MONTH 20	Day of month set
	↓	MONTH OF YEAR xx	
	<b>0</b> <b>5</b> <b>ENTR</b>	MONTH OF YEAR 05	Month of year set
	↓	YEAR OF CENTURY xx	
<b>9</b> <b>6</b> <b>ENTR</b>	YEAR OF CENTURY 96	Year of century set	
<b>5 CCN Disable</b>	<b>5</b> <b>SET</b>	Disable CCN Control x	0=no, 1=yes Default: 0

LEGEND

**CCN** — Carrier Comfort Network  
**LCW** — Leaving Chilled Water

NOTE: If metric option is selected under **2** **SET**, temperatures are expressed in degrees Celsius and pressures are expressed in kPa.

**Table 18 — Reading and Changing Chilled Fluid Set Point**

KEYPAD ENTRY	DISPLAY RESPONSE	COMMENTS
1 [SET]	COOLING	Change set point from default to 48 F.
↓	Cool Set point 1 44.0 F default	
4 8 [ENTR]	Cool Set point 1 48.0 F	Set point change complete

**SERVICE FUNCTION** — This function allows the technician to view and input configuration data. Factory configuration data, field configuration data, and service configuration data may be viewed or entered through the keypad and display module. See Table 19 for a complete listing of configurable items. Whenever a processor module is replaced in the field, the complete list of configuration codes should be checked for correct settings. The current software version can be displayed. See Table 20.

Scroll down in this function to display configuration information including number of compressors, tonnage, and compressor must-trip amps.

**Password Protection of HSIO Configurable Service Points** — To modify configurations and values and to use the manual control subfunction, the password must be entered before the first change can be made. The default password is set to

1 1 1 1. See Table 21 for an example of how to enter the password to change the Lead/Lag configuration.

**Options Configuration Tables 1 and 2** — These subfunctions can be accessed by pressing 2 or 3 [SRVC] and scrolling down to display the configuration options. See Table 19 for a complete list of these options.

**Temperature Reset, Demand Limit and Head Pressure PID Configurations** — Press 4 [SRVC] and scroll down to view the configuration information. See Table 19 for a complete list.

**Factory Configuration Codes** — Pressing 5 [SRVC] allows entry into the factory and service configuration codes subfunction. Under this subfunction, there are 5 configuration codes that are downloaded at the factory. Each code is made up of 8 digits. If the processor module is replaced in the field, these 5 configuration codes should be checked using the keypad and HSIO display module. See Table 22 for a description of the factory configuration codes (codes 1 through 3) and service configuration codes (codes 4 and 5).

The factory and service configuration codes are found by pressing 5 [SRVC]. These are preset from the factory. They can be verified by following the description in Table 22. These codes MUST be checked and corrected in the field if the PSIO-1 module is replaced.

**NOTE:** The LOCAL/OFF/REMOTE switch must be in the OFF position to change configuration codes.

A label is applied to a control box panel with a list of factory and service codes for particular units. Table 23 shows how to configure a new PSIO-1 module for use in a 30HXC-106---501CA water cooled chiller.

**Transducer Calibration** — Press 7 [SRVC] and scroll down to view the transducer calibration information. See Table 19 for a complete list, and the Pressure Transducers section on page 59 for a description of this subfunction.


































**Manual Control Mode** — This control allows the user to have full control over the compressors, loaders, and the minimum load valve (if installed) of the machine. Normal safeties such as high pressure, oil level and pressure, and CPM related alarms are NOT bypassed in this control mode. The capacity control function and overrides ARE bypassed when using the manual control mode. To enter this mode, switch the LOR switch to OFF. Press 8 [SRVC] at the HSIO. The display will read Manual Control Enable - Disable. Press 1 [ENTR] and switch the LOR switch to Local. The display will change to Manual Control Enable - Enable. The Disable and Enable will appear on the second line of the display. See Table 19 for a complete list of this function.

Scroll down and press 1 [ENTR] to start the desired compressor. The control will start the compressor if the pre-lube cycle is passed, just as in normal operation. Press 1 [ENTR] to add loaders as desired and press 0 [ENTR] to turn off loaders and compressors. The Minimum Load Valve can be energized using the same procedure.

**Dual Chiller Configuration** — Press 9 [SRVC] to enter the Dual Chiller control configuration. This method of control is for a stand-alone Master/Slave combination of chillers and will NOT work with the Flotronic™ System Manager (FSM). The Minus One Pass Cooler option is required for this configuration.

The chillers should be piped for series flow through the coolers. The Master chiller must be downstream from the Slave chiller leaving water. Both the Master and Slave chiller must be connected to the same CCN Level II communications bus with different addresses. To enable the dual chiller configuration the CCN Enable function 2 [STAT] must be set to Enable for each chiller, otherwise each chiller will operate independently. This value can be activated through the HSIO or through a CCN device. Both chillers should be configured for Close Control 3 [SRVC] and require flow switches to be installed. For cooler pump control, wire both Master and Slave chiller outputs to the cooler pump starter. All system inputs (temperature reset, demand limit, dual set point, etc.) should be connected to the Master chiller. If Lead/Lag Balance is disabled, the Master chiller will always be the lead chiller. If Lead/Lag Balance is enabled, the control will alternate between the Master and Slave chillers to keep their respective run hours balanced within the value configured for Lead/Lag Balance Delta. The desired leaving fluid set point 1 [SET] for the Duplex chiller must be configured in the Master chiller. CCN Control of the chillers can be disabled locally through the HSIO by entering 5 [SET] and enabling the Disable CCN Control value. This value must be disabled before the chiller will return to Duplex control.

**Table 19 — Service Function and Subfunction Directory**

SUBFUNCTION	KEYPAD ENTRY	DISPLAY	COMMENT
<b>1 Service Configuration</b>		Software CESR_500100 Ver xxx	
		Unit Type x	1 = Air-cooled, 2 = Water-cooled 3 = Split system
		Number of Cir A Comp x	
		Compressor A1 Tonnage xx	
		Compressor A2 Tonnage xx	
		Oil Switch Configuration x	
		Number of Cir B Comp x	
		Compressor B1 Tonnage xx	
		Compressor B2 Tonnage xx	
		Max. Cond. Temp Setpoint xxx.x dF	30GX = 154 F (68 C) 30HXA = 152 F (67 C) 30HXC = 122 F (50 C)
		MOP Set point xx.x dF	Default = 52 F (11.1 C)
		Fan Staging Select x	Displays "Not Used" or a number. See Table 5
		CPM Board Used? Yes	
		Compr. A1 Must Trip Amps xxx.x	Value from CPM module. See Appendix A.
		Compr. A2 Must Trip Amps xxx.x	Value from CPM module. See Appendix A.
		Compr. B1 Must Trip Amps xxx.x	Value from CPM module. See Appendix A.
		Compr. B2 Must Trip Amps xxx.x	CURRENTLY NOT USED
<b>2 Options Configuration 1</b>		Cooler Fluid Select x	1 = Water (Default), 2 = Medium Temp Brine 3 = Low Temp Brine (HX only)
		Min. Load Valve Select x	Displays Enable/Dsable Default: Dsable
		Loading Sequence Select x	1 = Equal circuit, 2 = Staged circuit Default: 2. See page 6
		Lead/Lag Sequence Select x	1 = Automatic (Default), 2 = Circuit A leads, 3 = Circuit B leads
		Head Press. Control Type x	0 = None (Default, HX), 1 = Air cooled (Default, GX), 2 = Water cooled
		Motormaster Select x	0 = None (Default), 1 = Direct control
		Water Valve Type x	0 = None (Default), 1 = 4-20 mA, 2 = 0-10 V, 3 = 20-4 mA, 4 = 10-0 V
		Ext. Reset Sensor Select x	0 = Space Temp Thermistor (Default) 1 = Outside Air Thermistor
		Cooler Pump Interlock x	0 = No interlock 1 = Interlock enabled (Default)
		Cooler Pump Control x	0 = Not controlled (Default) 1 = On/Off Control
		Condenser Pump Control x	0 = Not controlled (Default) 1 = On/Off Control 2 = Off when stages equal 0 (unit off)
		Condenser Flow Switch x	Displays Enable/Dsable Default: Dsable
		Condenser Water Sensors x	0 = Not used (Default), 1 = Used
		Heat Reclaim Sensors x	CURRENTLY NOT SUPPORTED
	<b>3 Options Configuration 2</b>		Cooling Setpoint Select x
		Heating Setpoint Select x	0 = Single set point (Default), 1 = Dual set point (switch controlled), 2 = Dual set point (clock controlled) CURRENTLY NOT SUPPORTED

See Legend on page 34.

**Table 19 — Service Function and Subfunction Directory (cont)**

SUBFUNCTION	KEYPAD ENTRY	DISPLAY	COMMENT
3 Options Configuration 2 (cont)		Ramp Load Select x	0 = Disabled, 1 = Enabled (Default) See page 8
		Clock Control Select x	0 = No clock control (Default) 1 = Local clock control 65 = CCN Clock Control
		Ice Configuration Select x	0 = Disabled (Default) 1 = Clock Control 2 = Demand Limit Control
		OAT Sensor Select x	0 = Disabled, 1 = Enabled Default: 0
		Remote Alarm Select x	0 = Disabled, 1 = Enabled Default: 0
		Alarm Reset Select x	0 = Not selected, 1 = Selected (Default, allows use of LOR switch to reset alarms)
		Close Control Select x	0 = Disabled, 1 = Enabled Default: 0. See page 7
		Deadband Multiplier x.x	Default: 1.0
		Current Unbalance Alarm x	Alarm at 10% imbalance; 0 = Disabled, 1 = Enabled Default: 1
		Voltage Unbalance Alarm x	Alarm at 3% imbalance; 0 = Disabled, 1 = Enabled Default: 1
	4 Reset Configuration Table		COOLING RESET TYPE 1
		Degrees Reset at 20 mA xx.x dF	Default: 0
		COOLING RESET TYPE 2	
		Remote temp=No Reset xx.x dF	Default: 20
		Remote temp=Full Reset xx.x dF	Default: 125
		Degrees Reset xx.x dF	Default: 0
		COOLING RESET TYPE 3	
		CHW Delta T=No Reset xx.x dF	Default: 15
		CHW Delta T=Full Reset xx.x dF	Default: 0
		Degrees Reset xx.x dF	Default: 0
		COOLING RESET	
		Select/Enable Reset Type x	0 = No Reset (Default) , 1 = 4-20 mA Reset, 2 = External Reset, 3 = Return Fluid Reset
		HEATING RESET TYPE 1	CURRENTLY NOT SUPPORTED
		Degrees Reset at 20 mA xx.x dF	Default: 0
		HEATING RESET TYPE 2	CURRENTLY NOT SUPPORTED
		Remote temp=No Reset xx.x dF	Default: 125
		Remote temp=Full Reset xx.x dF	Default: 20
		Degrees Reset xx.x dF	Default: 0
		HEATING RESET TYPE 3	CURRENTLY NOT SUPPORTED
		HTW Delta T=No Reset xx.x dF	Default: 15
		HTW Delta T=Full Reset xx.x dF	Default: 0
		Degrees Reset xx.x dF	Default: 0
		HEATING RESET	
		Select/Enable Reset Type x	0 = No Reset (Default), 1 = 4-20 mA reset, 2 = External reset, 3 = Return Fluid reset
		DEMAND LIMIT	See Demand Limit section, page 39
		Demand Limit at 20 mA xxx.x%	Enter 0-100, Default: 0%



**Table 19 — Service Function and Subfunction Directory (cont)**

SUBFUNCTION	KEYPAD ENTRY	DISPLAY	COMMENT
<b>4 Reset Configuration Table (cont)</b>		Demand Limit Select x	0 = None (Default), 1 = Two step switch, 2 = 4-20 mA, 3 = CCN Loadshed
		Loadshed Group Number x	0-99, Default: 0
		Loadshed Demand Delta xxx%	0-60%,Default: 0
		Maximum Loadshed Time xx min	0-120 min, Default: 60 min
		WATER VALVE PID	
		Proportional PID Gain x.x	Default = 1.0 Adjustable from -20.0 to 20.0
		Integral PID Gain x.x	Default = 0.1 Adjustable from -20.0 to 20.0
		Derivative PID Gain x.x	Default = 0.0 Adjustable from -20.0 to 20.0
		AIR MOTOR MASTER PID	
		Proportional PID Gain x.x	Default = 1.0 Adjustable from -20.0 to 20.0
		Integral PID Gain x.x	Default = 0.1 Adjustable from -20.0 to 20.0
		Derivative PID Gain x.x	Default = 0.0 Adjustable from -20.0 to 20.0
	<b>5 Factory Configuration Codes</b>		FACTORY CODES
		Configuration Code 1 xxxxxxx	Factory set. See Table 22.
		Configuration Code 2 xxxxxxx	Factory set. See Table 22.
		Configuration Code 3 xxxxxxx	Factory set. See Table 22.
		SERVICE CODES	
		Configuration Code 4 xxxxxxx	Factory set. See Table 22.
		Configuration Code 5 xxxxxxx	Factory set. See Table 22.
<b>6 NOT USED</b>			
<b>7 Transducer Calibration</b>		CALIBRATION OFFSET	See Pressure Transducer Calibration, page 59
		CIRCUIT A PRESSURE	
		Discharge Pressure xxx.x PSI	
		Suction Pressure xxx.x PSI	
		A1 Oil Pressure xxx.x PSI	
		A2 Oil Pressure xxx.x PSI	
		Economizer Pressure xxx.x PSI	
		CALIBRATION OFFSET	
		CIRCUIT B PRESSURE	
		Discharge Pressure xxx.x PSI	
		Suction Pressure xxx.x PSI	
		B1 Oil Pressure xxx.x PSI	
		B2 Oil Pressure xxx.x PSI	
		Economizer Pressure xxx.x PSI	
		Calibrate All at 0 PSIG No	
		Last Calibration Date mmm dd - yy	

See Legend on page 34.

**Table 19 — Service Function and Subfunction Directory (cont)**

SUBFUNCTION	KEYPAD ENTRY	DISPLAY	COMMENT	
<b>8 Manual Control Table</b>	8 SHVC	Manual Control Enable Dsable	LOR switch should be in OFF position	
	1 ENTR	Password Protected Enter:	Will be displayed if not entered earlier in current HSIO use	
	1 1 1 1 ENTR	Manual Control Enable Dsable		
	1 ENTR	Manual Control Enable Enable	Switch LOR switch to Local before proceeding	
	↓	Circuit A Compressor 1 Off		
	1 ENTR	Circuit A Compressor 1 On	Provided no alarms exist, control will attempt circuit start within 2 minutes. Press 0 ENTR to stop circuit.	
	↓	Circuit A Compressor 2 Off	1 ENTR to enable, 0 ENTR to stop	
	↓	Circuit A Loader 1 Off	1 ENTR to enable, 0 ENTR to stop	
	↓	Circuit A Loader 2 Off	1 ENTR to enable, 0 ENTR to stop	
	↓	Circuit A Min Load Valve Off	1 ENTR to enable, 0 ENTR to stop	
	↓	Circuit B Compressor 1 Off	1 ENTR to enable, 0 ENTR to stop	
	↓	Circuit B Compressor 2 Off	1 ENTR to enable, 0 ENTR to stop	
	↓	Circuit B Loader 1 Off	1 ENTR to enable, 0 ENTR to stop	
	↓	Circuit B Loader 2 Off	1 ENTR to enable, 0 ENTR to stop	
	↓	Circuit B Min Load Valve Off	1 ENTR to enable, 0 ENTR to stop	
	<b>9 Dual Chiller Configuration</b>	9 SHVC	MST_SLV	
		↓	Master/Slave Select 0/1/2	0 = Disabled 1 = Master 2 = Slave
↓		Slave Address 0	Default = 0 Adjustable from 0-236	
↓		Lead/Lag Balance 0/1	0 = Disabled 1 = Enabled	
↓		Lead/Lag Balance Delta xxx hours	Default = 168 Adjustable from 40-400	

**LEGEND**

- CCN** — Carrier Comfort Network
- CHW** — Chilled Water
- CPM** — Compressor Protection Module
- HSIO** — Standard Keypad
- HTW** — Hot Water
- LOR** — Local/Off/Remote
- MOP** — Maximum Operating Pressure
- OAT** — Outdoor-Air Temperature
- PID** — Proportional Integral Derivative

**Table 20 — Displaying Current Software Version**

FUNCTION	KEYPAD ENTRY	DISPLAY	COMMENT
Software Version	1 <b>SERV</b>	Software CESR_500100 Ver XXX	Carrier Software Part Number, where XXX is the revision number.

**Table 21 — Compressor Lead/Lag Configuration**

SUB-FUNCTION	KEYPAD ENTRY	DISPLAY
Options Configuration 1	2 <b>SRVG</b>	Cooler Fluid Select 1
	↓	Min. Load Valve Select Dsable
	↓	Loading Sequence Select 1
	↓	Lead/Lag Sequence Select 1
	2 <b>ENTR</b>	PASSWD PROTECTED FUNC Enter Password:
	1 1 1 1 <b>ENTR</b>	Lead/Lag Sequence Select 0
	2 <b>ENTR</b>	Lead/Lag Sequence Select 2

NOTE: Configurations may be modified after entering the password. The password is only required to be entered once. After a period of 10 minutes of no HSIO activity, the user is automatically logged out and the control requires that the password be entered on the next use.

**Table 22 — Factory and Service Configuration Code Values**

UNIT MODEL NUMBER	CONF. CODE 1*	CONF. CODE 2	CONF. CODE 3	CONF. CODE 4	CONF. CODE 5
30GX080	11460010	13900000	00000170	15400521	12000093
30GX090,105	11560010	13900000	00000180	15400521	12000093
30GX106	11560010	13900000	00000180	15400521	14000095
30GX115	11660010	13900000	00000190	15400521	14000095
30GX125	11660010	14600000	00000161	15400521	14000095
30GX136	11660010	15600000	00000162	15400521	14000095
30GX150	11560010	18000000	00000095	15400521	16000097
30GX151	11800010	15600000	00000176	15400521	07000088
30GX160	11660010	18000000	00000105	15400521	16000097
30GX161	11800010	16600000	00000177	15400521	07000088
30GX175	11800010	18000000	00000119	15400521	07000088
30GX176	11800010	18000000	00000119	15400521	03000084
30GX205	12663910	18000000	00000145	15400521	07000088
30GX206	12803910	16600000	00000217	15400521	09000090
30GX225	12804610	18000000	00000166	15400521	07000088
30GX226	12804610	18000000	00000166	15400521	09000090
30GX250	12806610	18000000	00000186	15400521	09000090
30GX251	12808010	16600000	00000258	15400521	05000086
30GX265	12808010	18000000	00000200	15400521	05000086
30HXA076	31390010	13900000	00000183	15200521	02000063
30HXA086	31460010	13900000	00000190	15200521	02000063
30HXA096	31560010	13900000	00000200	15200521	02000063
30HXA106	31660010	13900000	00000210	15200521	02000063
30HXA116	31660010	14600000	00000181	15200521	02000063
30HXA126	31660010	15600000	00000182	15200521	02000063
30HXA136	31800010	15600000	00000196	15200521	02000063
30HXA146	31800010	16600000	00000197	15200521	02000063
30HXA161	31800010	15600000	00000196	15200521	02000063
30HXA171	31660010	18000000	00000125	15200521	02000063
30HXA186	31800010	18000000	00000139	15200521	02000063
30HXA206	32663910	18000000	00000165	15200521	02000063
30HXA246	32805610	18000000	00000196	15200521	02000063
30HXA261	32806610	18000000	00000206	15200521	02000063
30HXA271	32808010	18000000	00000220	15200521	02000063
30HXC076	21390010	13900000	00000173	12200521	00000058
30HXC086	21460010	13900000	00000180	12200521	00000058
30HXC096	21560010	13900000	00000190	12200521	00000058
30HXC106	21660010	13900000	00000200	12200521	00000058
30HXC116	21660010	14600000	00000171	12200521	00000058
30HXC126	21660010	15600000	00000172	12200521	00000058
30HXC136	21800010	15600000	00000186	12200521	00000058
30HXC146	21800010	16600000	00000187	12200521	00000058
30HXC161	21800010	15600000	00000186	12200521	00000058
30HXC171	21660010	18000000	00000115	12200521	00000058
30HXC186	21800010	18000000	00000129	12200521	00000058
30HXC206	22663910	18000000	00000155	12200521	00000058
30HXC246	22805610	18000000	00000186	12200521	00000058
30HXC261	22806610	18000000	00000196	12200521	00000058
30HXC271	22808010	18000000	00000210	12200521	00000058

\*Unit Type will be listed as air cooled, water cooled, or remote split system. Unit type is first digit in Configuration Code 1 and is 1 for 30GX units, 2 for 30HXC units, and 3 for 30HXA cooling only chillers. For other options, see Table 19 under the Service subfunction. A label listing configuration codes is located on the control box door or panel.

**Table 23 — Entering Configuration Codes**

KEYPAD ENTRY	DISPLAY RESPONSE
<div style="border: 1px solid black; display: inline-block; padding: 2px;">5</div> <div style="border: 1px solid black; display: inline-block; padding: 2px;">SRVC</div> <div style="border: 1px solid black; display: inline-block; padding: 2px;">↓</div>	FACTORY CODES
<div style="border: 1px solid black; display: inline-block; padding: 2px;">2</div> <div style="border: 1px solid black; display: inline-block; padding: 2px;">1</div> <div style="border: 1px solid black; display: inline-block; padding: 2px;">6</div> <div style="border: 1px solid black; display: inline-block; padding: 2px;">6</div> <div style="border: 1px solid black; display: inline-block; padding: 2px;">0</div> <div style="border: 1px solid black; display: inline-block; padding: 2px;">0</div> <div style="border: 1px solid black; display: inline-block; padding: 2px;">1</div> <div style="border: 1px solid black; display: inline-block; padding: 2px;">0</div> <div style="border: 1px solid black; display: inline-block; padding: 2px;">ENTR</div> <div style="border: 1px solid black; display: inline-block; padding: 2px;">↓</div>	Configuration Code 1 00000000 Configuration Code 1 21660010
<div style="border: 1px solid black; display: inline-block; padding: 2px;">↓</div>	Configuration Code 2 00000000 Configuration Code 2 13900000
<div style="border: 1px solid black; display: inline-block; padding: 2px;">1</div> <div style="border: 1px solid black; display: inline-block; padding: 2px;">3</div> <div style="border: 1px solid black; display: inline-block; padding: 2px;">9</div> <div style="border: 1px solid black; display: inline-block; padding: 2px;">0</div> <div style="border: 1px solid black; display: inline-block; padding: 2px;">0</div> <div style="border: 1px solid black; display: inline-block; padding: 2px;">0</div> <div style="border: 1px solid black; display: inline-block; padding: 2px;">0</div> <div style="border: 1px solid black; display: inline-block; padding: 2px;">0</div> <div style="border: 1px solid black; display: inline-block; padding: 2px;">ENTR</div> <div style="border: 1px solid black; display: inline-block; padding: 2px;">↓</div>	Configuration Code 3 00000000 Configuration Code 3 00000200
<div style="border: 1px solid black; display: inline-block; padding: 2px;">↓</div>	SERVICE CODES
<div style="border: 1px solid black; display: inline-block; padding: 2px;">↓</div>	Configuration Code 4 00000000 Configuration Code 4 12200521
<div style="border: 1px solid black; display: inline-block; padding: 2px;">1</div> <div style="border: 1px solid black; display: inline-block; padding: 2px;">2</div> <div style="border: 1px solid black; display: inline-block; padding: 2px;">2</div> <div style="border: 1px solid black; display: inline-block; padding: 2px;">0</div> <div style="border: 1px solid black; display: inline-block; padding: 2px;">0</div> <div style="border: 1px solid black; display: inline-block; padding: 2px;">5</div> <div style="border: 1px solid black; display: inline-block; padding: 2px;">2</div> <div style="border: 1px solid black; display: inline-block; padding: 2px;">1</div> <div style="border: 1px solid black; display: inline-block; padding: 2px;">ENTR</div> <div style="border: 1px solid black; display: inline-block; padding: 2px;">↓</div>	Configuration Code 5 00000000 Configuration Code 5 00000058
<div style="border: 1px solid black; display: inline-block; padding: 2px;">0</div> <div style="border: 1px solid black; display: inline-block; padding: 2px;">0</div> <div style="border: 1px solid black; display: inline-block; padding: 2px;">0</div> <div style="border: 1px solid black; display: inline-block; padding: 2px;">0</div> <div style="border: 1px solid black; display: inline-block; padding: 2px;">0</div> <div style="border: 1px solid black; display: inline-block; padding: 2px;">0</div> <div style="border: 1px solid black; display: inline-block; padding: 2px;">5</div> <div style="border: 1px solid black; display: inline-block; padding: 2px;">8</div> <div style="border: 1px solid black; display: inline-block; padding: 2px;">ENTR</div>	

**SCHEDULE FUNCTION** — This function provides a means to automatically switch the chiller from an occupied mode to an unoccupied mode. Refer to Table 24 for a complete description of the function.

The schedules consist of 8 user-configurable occupied time periods. The control supports time schedules for local control, remote control and ice building. These time periods can be flagged to be in effect or not in effect on each day of the week. The day begins at 00.00 and ends at 24.00. The machine is in unoccupied mode unless a scheduled time period is in effect. If an occupied period is to extend past midnight, it must be programmed in the following manner: occupied period must end at 24:00 hours (midnight); a new occupied period must be programmed to begin at 00:00 hours.

**NOTE:** This is true only if the occupied period starts at 00:00 (midnight). If the occupied period starts at a time other than midnight, then the occupied period must end at 24:00 hours (midnight) and new occupied period must be programmed to start at 00:00 in order for the chiller to stay in the occupied mode past midnight. Each time schedule can be overridden to keep the chiller in an Occupied mode for 1, 2, 3 or 4 hours on a one-time basis.

**Dual Set Point Control** — This feature can be enabled to allow the use of a second or unoccupied cooling set point. The function can be either switch controlled or clock controlled. To enable switch control, set the Cooling Setpoint selection under 

3

SRVC

 to 1. See page 72 or 73 of Field Wiring section, depending on unit type, for switch input wiring to the PSIO-2 module. Configure Cool Setpoint 2 under 

1

SET

 to the desired value. The unit will then control leaving water temperature to Cool Setpoint 2 when the switch input is closed. To enable clock control, set the Cooling Setpoint selection under 

3

SRVC

 to 2. Set Cool Setpoint 2 to the desired unoccupied value. Using 

2

SCHD

, configure local operating schedules for the desired occupied and unoccupied time periods. The unit will then control leaving water temperature to Cool Setpoint 2 during unoccupied time periods.

**Table 24 — Schedule Function and Subfunction Directory**

SUBFUNCTION	KEYPAD ENTRY	DISPLAY	COMMENT
<b>1 Ice Build Schedule*</b>	<b>1</b> <b>SCHD</b>	SCHEDULES: OCCPC01S Timed Override: 00	Extended Occupied Time
	<b>2</b> <b>ENTR</b>	SCHEDULES: OCCPC01S Timed Override: 02	Two hour override entered
	<b>↓</b>	MTWTFSSH OCC UNOCC 01- 00000000 00:00 00:00	Displays current stored schedule (First 2 numbers are schedule, 01-08)
	<b>1 1 1 1 1 0 0 0 0</b> <b>ENTR</b>	MTWTFSSH OCC UNOCC 01- 11111000 00:00 00:00	Monday-Friday now occupied
	<b>2 1 . 0 0</b> <b>ENTR</b>	MTWTFSSH OCC UNOCC 01- 11111000 21:00 00:00	Occupied time now set
	<b>0 6 . 3 0</b> <b>ENTR</b>	MTWTFSSH OCC UNOCC 01- 11111000 21:00 06:30	Unoccupied time now set Ice Build schedule completed
	<b>↓</b>	MTWTFSSH OCC UNOCC 02- 00000000 00:00 00:00	Can enter up to 7 additional ice build schedules
<b>2 Local Schedule†</b>	<b>2</b> <b>SCHD</b>	SCHEDULES: OCCPC02S Timed Override: 00	Extended Occupied Time
	<b>↓</b>	MTWTFSSH OCC UNOCC 01- 00000000 00:00 00:00	Displays current stored schedule (First 2 numbers are schedule, 01-08)
	<b>1 1 1 1 1 0 0 0 0</b> <b>ENTR</b>	MTWTFSSH OCC UNOCC 01- 11111000 00:00 00:00	Monday-Friday now occupied
	<b>0 6 . 3 0</b> <b>ENTR</b>	MTWTFSSH OCC UNOCC 01- 11111000 06:30 00:00	Occupied time now set
	<b>2 1 . 0 0</b> <b>ENTR</b>	MTWTFSSH OCC UNOCC 01- 11111000 06:30 21:00	Unoccupied time now set Local schedule completed
	<b>↓</b>	MTWTFSSH OCC UNOCC 02- 00000000 00:00 00:00	Can enter up to 7 additional local schedules
<b>3 Remote Schedule (Currently Not Used)</b>	<b>3</b> <b>SCHD</b>	SCHEDULES: OCCPC65S Timed Override: 00	Extended Occupied Time
	<b>↓</b>	MTWTFSSH OCC UNOCC 01- 00000000 00:00 00:00	Displays current stored schedule (First 2 numbers are schedule, 01-08)
	<b>1 1 1 1 1 0 0 0 0</b> <b>ENTR</b>	MTWTFSSH OCC UNOCC 01- 11111000 00:00 00:00	Monday-Friday now occupied
	<b>0 6 . 3 0</b> <b>ENTR</b>	MTWTFSSH OCC UNOCC 01- 11111000 06:30 00:00	Occupied time now set
	<b>2 1 . 0 0</b> <b>ENTR</b>	MTWTFSSH OCC UNOCC 01- 11111000 06:30 21:00	Unoccupied time now set Remote schedule completed
	<b>↓</b>	MTWTFSSH OCC UNOCC 02- 00000000 00:00 00:00	Can enter up to 7 additional remote schedules
<b>4 Holiday Configuration**</b>	<b>4</b> <b>SCHD</b>	HOLIDAYS : HOLDY_01 Starts on 00/00 00 days	Can configure holiday start day and duration
	<b>1 2 . 2 3</b> <b>ENTR</b>	HOLIDAYS : HOLDY_01 Starts on 12/23 00 days	Start of holiday set
	<b>1 0</b> <b>ENTR</b>	HOLIDAYS : HOLDY_01 Starts on 12/23 10 days	Holiday duration set
<b>5-33 Holiday Configuration</b>	<b>5</b> through <b>3 3</b> <b>SCHD</b>	HOLIDAYS : HOLDY_02 Starts on 00/00 00 days	Allows configuration of 29 additional holiday periods

\*Ice configuration select must be set to 1 for clock control. The ice configuration can be accessed by pressing **3** **SRVC** and scrolling down.

†Clock control select must be set to 1 for clock control. The clock control can be accessed by pressing **3** **SRVC** and scrolling down.

\*\*The BROADCAST function (BRODEFS table) must be activated (change to "YES" and download) when using the LID-2B controller, Building Supervisor or ComfortWorks™ software for the control to recognize holidays.

**Temperature Reset** — The control system is capable of providing leaving fluid temperature reset based on return fluid temperature. Because the temperature difference between leaving and return temperature is a measure of the building load, return fluid temperature reset is essentially an average building load reset method.

Under normal operation, the chiller maintains a constant leaving fluid temperature approximately equal to the chilled fluid set point. As building load drops from 100% down to 0%, entering cooler fluid temperature drops in proportion to load. Thus, the temperature drop across the cooler drops from a typical 10° F (5.5° C) at full load to a theoretical 0° F (0° C) at no load. See Fig. 8.

At partial load, leaving chilled fluid temperature may be lower than required. If this is allowed to increase (reset), the efficiency of the chiller increases. Amount of reset can be defined as a function of cooler temperature drop. This is a simple linear function that requires 3 pieces of input data for the set function that will vary depending on measurement method used. See the following sections and Table 25.

NOTE: Reset set points are not accessible unless the reset function is enabled first. The Control Point will be recalculated taking into account the set point plus the amount of reset. This is done as a field configuration. Select one of the 3 choices for type of reset: Return Fluid Reset, External Temperature Reset, or 4 to 20 mA Signal Reset. See Table 25.

If dual set point control is enabled, the amount of reset is applied to whichever set point is in effect at the time.

Tables 26-28 demonstrate how to activate reset.

**EXTERNAL TEMPERATURE RESET** — In this example, the unit set point is reset from full load at 90 F (32 C) to a maximum reset value of 10° F (5.5° C) at 25 F (–6.7 C) outdoor ambient. This means that if the chilled fluid set point is 44 F (6.7 C), there is no reset if the temperature is 90 F (32 C). At a temperature of 25 F (–6.7 C), the chilled fluid set point would be reset to 54 F (12.2 C). See Fig. 8 and Table 26. A field-supplied outdoor air thermistor must be connected to PSIO-2 as shown in Fig. 37.

To activate this function for space temperature reset leave both the External Reset Sensor Select and the OAT Sensor Select at 0, and change the Select/Enable Reset Type to 2, following the procedure in Table 26.

**EXTERNALLY POWERED RESET (4 to 20 mA)** — In this example, the unit set point is reset from full load at 4 mA to a maximum reset value of 10° F (5.5° C) at 20 mA. See Fig. 9 and Table 27.

**RETURN FLUID TEMPERATURE RESET** — In this example, the unit set point is reset from full load based on the chilled fluid return temperature. The example uses a reset value of 10 degrees at full reset. Full reset is at a 2-degree temperature difference across the cooler and no reset would be at a 10° F difference across the cooler. See Fig. 10 and Table 28.

**Demand Limit** — Demand Limit is a feature that allows the unit capacity to be limited during periods of peak energy usage. There are 3 types of demand limiting which can be configured. The first type is through 2 switch inputs, which will reduce the maximum capacity to 2 user-configurable percentages. The second type is by a 4 to 20 mA signal input which will reduce the maximum capacity linearly between 100% at a 4 mA input signal (no reduction) down to the user-configurable level at a 20 mA input signal. The third type uses the CCN Loadshed module and has the ability to limit the current operating capacity to maximum and further reduce the capacity if required.

To use Demand Limit, select the type of demand limiting to use. Then configure the Demand Limit set points based on the type selected.

**DEMAND LIMIT (Switch Controlled, 30GX only)** — In this example, demand limit by switch control will be configured and the switch set points will be set at 75% and 40%. Capacity steps are controlled by 2 relay switch inputs field wired to PSIO-2, terminal 28 for switch 1 and terminal 25 for switch 2. See Table 29.

For Demand Limit by switch control, closing the first stage demand limit contact will put the unit on the first demand limit level. The unit will not exceed the percentage of capacity entered as Demand Switch 1 set point. Closing contacts on the second demand limit switch prevents the unit from exceeding the capacity entered as Demand Switch 2 set point. The demand limit stage that is set to the lowest demand takes priority if both demand limit inputs are closed. If the demand limit percentage does not match unit staging, the unit will limit capacity to the closest capacity stage.

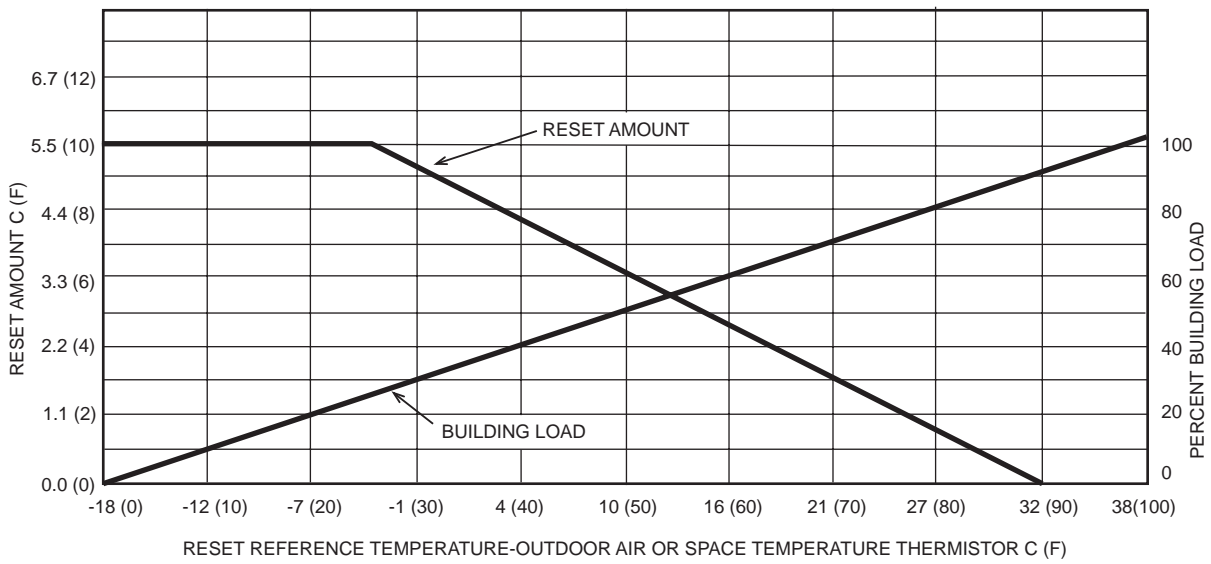
To Disable Demand Limit: Enter   as shown in Table 29. Scroll down to Demand Limit Select and press   to select no Demand Limit control.

**Table 25 — Temperature Reset Set Point Limits**

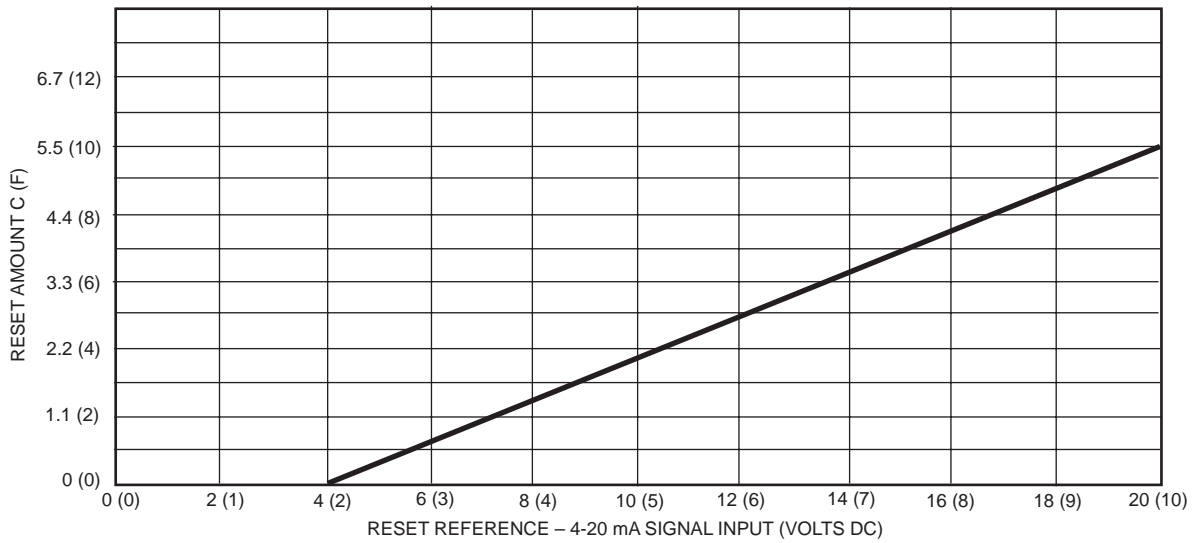
INPUT DATA DESCRIPTION	MEASUREMENT METHOD					
	Type 1 — 4-20 mA (With 500-Ohm Resistor)		Type 2 — OAT/Occupied Space (External Sensor)		Type 3 — Return Fluid	
	Variable	Limits	Variable	Limits	Variable	Limits
<b>Maximum Reset Amount — Allowable range for maximum amount which LWT set point is reset.</b>	Degrees Reset at 20 mA	(–30 to 30 F) –34 to –1 C	Degrees Reset	(–30 to 30 F) –34 to –1 C	Degrees Reset	(–30 to 30 F) –34 to –1 C
<b>Maximum Reset Reference — Temperature at which maximum reset occurs.</b>	—	—	Remote temp = Full Reset	(20 to 125 F) –7 to 52 C	CHW Delta T = Full Reset	(0 to 15 degrees F) 0 to 8° C cooler temperature rise
<b>Minimum Reset Reference — Temperature at which no reset occurs.</b>	—	—	Remote temp = No Reset	(20 to 125 F) –7 to 52 C	CHW Delta T = No Reset	(0 to 15 degrees F) 0 to 8° C cooler temperature rise

LEGEND

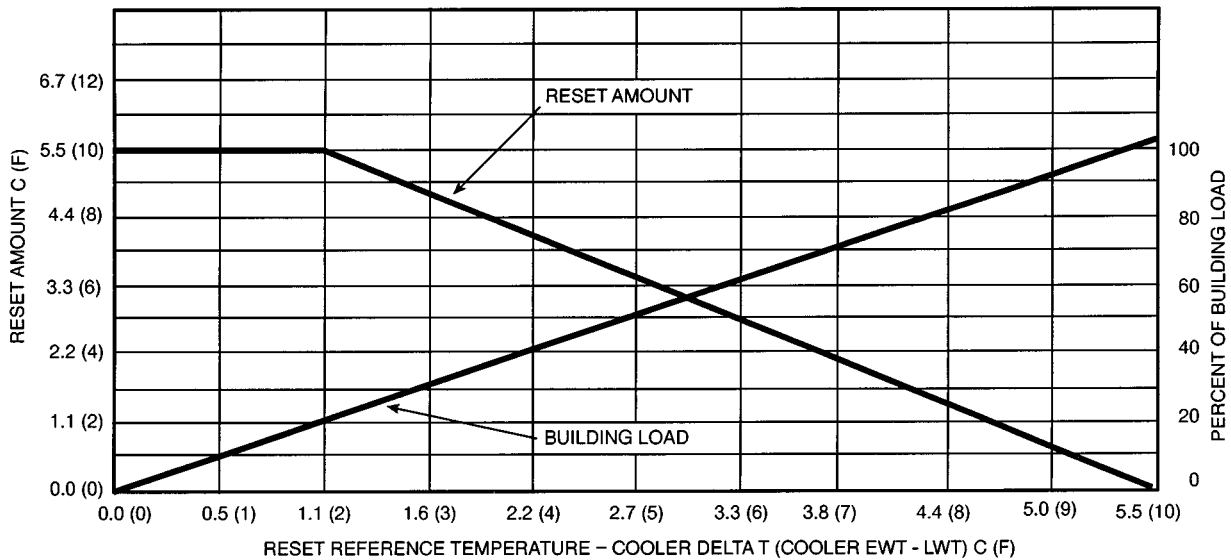
- CHW — Chilled Water
- OAT — Outdoor-Air Temperature
- LWT — Leaving Fluid Temperature



**Fig. 8 — Cooling External Temperature Reset**



**Fig. 9 — 4 to 20 mA Cooling Temperature Reset**



**Fig. 10 — Cooling Return Water Reset**



**Table 26 — Setting External Temperature Reset**

KEYPAD ENTRY	DISPLAY RESPONSE	COMMENTS
2 <b>SRVC</b>	Cooler Fluid Select 1	
↓	Min. Load Valve Select Disable	
↓	Loading Sequence Select 1	
↓	Lead/Lag Sequence Select 1	
↓	Head Press. Control Type 0	
↓	Motormaster Select 0	
↓	Water Valve Type 0	
↓	Ext. Reset Sensor Select 0	
1 <b>ENTR</b>	Ext. Reset Sensor Select 1	Outdoor Ambient sensor selected for reset
3 <b>SRVC</b>	Cooling Setpoint Select 0	
↓	Heating Setpoint Select 0	
↓	Ramp Load Select 0	
↓	Clock Control Select 1	
↓	Ice Configuration Select 0	
↓	OAT Sensor Select 0	
1 <b>ENTR</b>	OAT Sensor Select 1	OAT sensor enabled
4 <b>SRVC</b>	COOLING RESET TYPE 1	
↓	Degrees Reset at 20 mA 0.0 dF	
↓	COOLING RESET TYPE 2	
↓	Remote temp = No Reset 20.0 dF	
2 5 <b>ENTR</b>	Remote temp = No Reset 25.0 dF	
↓	Remote temp = Full Reset 125.0 dF	
9 0 <b>ENTR</b>	Remote temp = Full Reset 90.0 dF	
↓	Degrees Reset 0.0 dF	
1 0 <b>ENTR</b>	Degrees Reset 10.0 dF	
↓	COOLING RESET	Scroll down to this point.
↓	Select/Enable Reset Type 0	
2 <b>ENTR</b>	Select/Enable Reset Type 2	External reset selected

**Table 27 — Setting Externally Powered Reset**

KEYPAD ENTRY	DISPLAY RESPONSE	COMMENTS
4 <b>SRVC</b>	COOLING RESET TYPE 1	
↓	Degrees Reset at 20 mA 0.0 dF	
1 0 <b>ENTR</b>	Degrees Reset at 20 mA 10.0 dF	
↓	COOLING RESET	Scroll down to this point
↓	Select/Enable Reset Type 0	
1 <b>ENTR</b>	Select/Enable Reset Type 1	4-20 mA reset selected

**Table 28 — Setting Return Fluid Temperature Reset**

KEYPAD ENTRY	DISPLAY RESPONSE	COMMENTS
4 <b>SRVC</b>	COOLING RESET TYPE 1	
↓	COOLING RESET TYPE 3	Scroll down to this point.
↓	CHW Delta T = No Reset 15.0 dF	
1 0 <b>ENTR</b>	CHW Delta T = No Reset 10.0 dF	
↓	CHW Delta T = Full Reset 0.0 dF	
2 <b>ENTR</b>	CHW Delta T = Full Reset 2.0 dF	
↓	Degrees Reset 0.0 dF	
1 0 <b>ENTR</b>	Degrees Reset 10.0 dF	
↓	COOLING RESET	
↓	Select/Enable Reset Type 0	
3 <b>ENTR</b>	Select/Enable Reset Type 3	Return Fluid reset selected

EXTERNALLY POWERED DEMAND LIMIT (4 to 20 mA Controlled) — In this example, the 4 to 20 mA Demand Limit will be configured and the 20 mA demand limit percentage will be set to 50%. See Table 30 and Fig. 11.

DEMAND LIMIT (CCN Loadshed Controlled) — In this example, the CCN Loadshed Demand Limit will be configured. The loadshed group will be set to 1, demand delta will be set to 40% and the maximum loadshed time will be set to 90 minutes. See Table 31.

The Loadshed Group number is established by the CCN system designer. The PIC (product integrated control) will respond to a Redline command from the Loadshed control. When the Redline command is received, the current stage of capacity is set to the maximum stages available. Should the loadshed control send a Loadshed command, the PIC will reduce the current stages by the value entered for Loadshed Demand delta. For the above example the Loadshed Demand delta is 40%. If the chiller is operating at 80% of total capacity when a Redline command is received, the maximum available capacity is set to 80%. When a Loadshed command is received, the chiller capacity will be reduced by 40%. The chiller can now operate at a total capacity of no more than 48%  $[80\% - (80\% \times 40\%)]$  until a Cancel Redline or Cancel Loadshed command is received. The control will disable the Redline/Loadshed command if no Cancel command has been received within the configured maximum loadshed time limit.

**Table 29 — Setting Switch-Controlled Demand Limit**

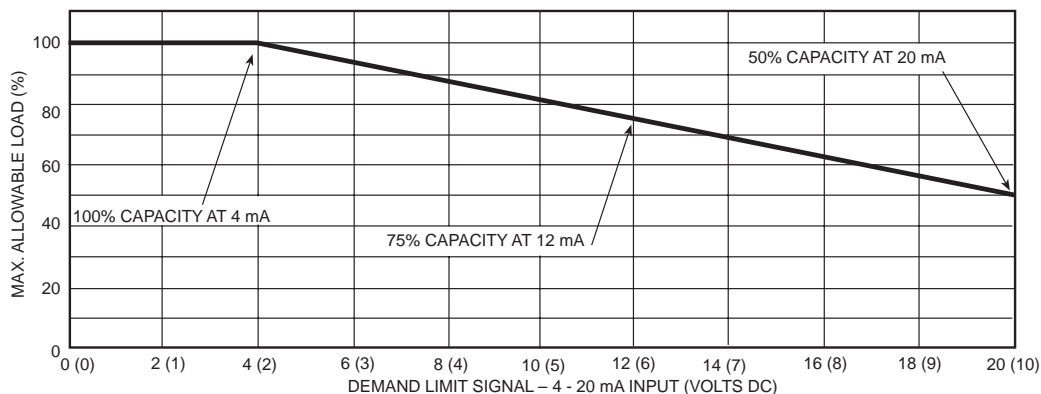
KEYPAD ENTRY	DISPLAY RESPONSE	COMMENTS
4 [SRVC]	COOLING RESET TYPE 1	
↓	DEMAND LIMIT	Scroll down to this point
↓	Demand Limit at 20 mA 0.0%	
↓	Demand Limit Select 0	
1 [ENTR]	Demand Limit Select 1	Two step switch configured
1 [SET]	COOLING	
↓	DEMAND LIMIT	Scroll down to this point
↓	Demand Switch 1 Setpoint 80.0%	
7 5 [ENTR]	Demand Switch 1 Setpoint 75.0	
↓	Demand Switch 2 Setpoint 50.0%	
4 0 [ENTR]	Demand Switch 2 Setpoint 40.0%	Configuration complete

**Table 30 — Setting Demand Limit (4 to 20 mA Controlled; 2 to 10 vdc With 500-Ohm Resistor)**

KEYPAD ENTRY	DISPLAY RESPONSE	COMMENTS
4 [SRVC]	COOLING RESET TYPE 1	
↓	DEMAND LIMIT	Scroll down to this point
↓	Demand Limit at 20 mA 0.0%	
5 0 [ENTR]	Demand Limit at 20 mA 50.0%	
↓	Demand Limit Select 0	
2 [ENTR]	Demand Limit Select 2	4-20 mA control configured

**Table 31 — Setting Demand Limit (CCN Loadshed Controlled)**

KEYPAD ENTRY	DISPLAY RESPONSE	COMMENTS
4 [SRVC]	COOLING RESET TYPE 1	
↓	DEMAND LIMIT	Scroll down to this point
↓	Demand Limit at 20 mA 0.0%	
↓	Demand Limit Select 0	
3 [ENTR]	Demand Limit Select 3	CCN Loadshed control configured
↓	Loadshed Group Number 0	
1 [ENTR]	Loadshed Group Number 1	
↓	Loadshed Demand Delta 0	
4 0 [ENTR]	Loadshed Demand Delta 40%	
↓	Maximum Loadshed Time 60 min	
9 0 [ENTR]	Maximum Loadshed Time 90 min	Configuration complete



**Fig. 11 — 4 to 20 mA Demand Limiting**

## TROUBLESHOOTING

The 30GX,HX screw chiller control has many features to aid in troubleshooting. By using the keypad and display module and the Status function, operating conditions of the chiller are displayed while the unit is running. The Test function allows for operational checkout of compressor loaders, fans, EXVs, solenoids, and other components while the chiller is stopped. The Service function displays how configurable items are configured and provides a manual control mode where the compressors can be started and loaded. If an operating fault is detected, an alarm is generated and an alarm code is displayed under the subfunction **1** **STAT** along with an explanation of the fault. Up to 10 current alarm codes are stored under this subfunction. For checking specific items, see Table 10.

**Checking Display Codes** — To determine how the machine has been programmed to operate, check the diagnostic information displayed in the Status function and the configuration information displayed in the Service function.

**Unit Shutoff** — To shut the unit off, move the LOCAL/OFF/REMOTE switch to OFF position. All compressors and solenoids stop immediately.

**Complete Unit Stoppage** — Complete unit stoppage can be caused by any of the following conditions:

- cooling load satisfied
- remote on/off contacts open
- programmed schedule
- emergency stop command from CCN
- general power failure
- blown fuse in control power feed disconnect
- open control circuit fuse(s)
- LOCAL/OFF/REMOTE switch moved to OFF position
- freeze protection trip
- low flow protection trip
- open contacts in chilled water flow switch (optional)
- Open contacts in any auxiliary interlock. Terminals that are jumpered from factory are in series with control switch. Opening the circuit between these terminals places unit in Stop mode, similar to moving the control switch to OFF position. Unit cannot start if these contacts are open. If they open while unit is running, the unit stops
- cooler entering or leaving fluid thermistor failure
- low/high transducer supply voltage
- loss of communications between processor module and other control modules
- low refrigerant pressure
- off-to-on delay is in effect

### ⚠ CAUTION

If a stoppage occurs more than once as a result of any of the above safety devices, determine and correct the cause before attempting another restart.

**Single Circuit Stoppage** — Single circuit stoppage can be caused by the following:

- low oil pressure
- open contacts in high pressure switch
- low refrigerant pressure
- thermistor failure
- transducer failure
- alarm condition from CPM module
- Overload relay trip. Stoppage of one circuit by a safety device action does not affect other circuit. When a safety device trips, the circuit is shut down immediately and EXV closes

### ⚠ CAUTION

If a stoppage occurs more than once as a result of any of the preceding safety devices, determine and correct the cause before attempting another restart.

**Restart Procedure** — After the cause for stoppage has been corrected, restart is either automatic or manual, depending on the fault. Manual reset requires that the alarm(s) be reset via the HSIO. Press **1** **STAT** and then **1** **ENTR** to clear manual reset alarms. If the Alarm Reset Select feature is selected ( **3** **SHVC** ), a manual reset alarm can also be reset by switching the LOR switch from LOCAL/REMOTE to OFF and back to LOCAL/REMOTE again. If an alarm was from the CPM module, depress the reset button located on the HSIO or fuse bracket before clearing the alarm through the HSIO. Some typical fault conditions are described in Table 32. For a complete list of fault conditions, codes, and reset type, see Table 33.

**POWER FAILURE EXTERNAL TO THE UNIT** — Unit restarts automatically when power is restored.

**Table 32 — Typical Stoppage Faults and Reset Types**

STOPPAGE FAULT	RESET TYPE
Loss of Condenser Flow (30HXC)	Manual reset
Cooler Freeze Protection (Chilled Fluid, Low Temperature)	Auto reset first time, manual if repeated in same day
Chilled Fluid Pump Interlock	Automatic reset (Manual for closed contacts when pump is off)
Control Circuit Fuse Blown	Unit restarts automatically when power is restored
High-Pressure Switch Open	Manual reset
Low Sat. Suction Temperature	Manual reset
Low Oil Pressure	Manual reset
Loss of Communications with WSM or FSM controller	Automatic reset

#### LEGEND

**FSM** — Flotronic™ System Manager  
**WSM** — Water System Manager

**Alarms and Alerts** — These are warnings of abnormal or fault conditions, and may cause either one circuit or the whole unit to shut down. They are assigned code numbers as described in Table 33. The alarm descriptions are displayed on the HSIO when the **1** **STAT** subfunction is entered. When a communication loss occurs to a hardware point, an alert or alarm may be generated. Refer to Table 34. The PSIO also recognizes illegal configurations. Illegal configurations are shown in Table 35.

Table 33 contains a detailed description of each alarm and alert code error and possible cause. Manual reset is accomplished by entering **1** **STAT** from the HSIO and pressing **1** **ENTR** or moving the LOCAL/OFF/REMOTE Switch to the OFF position, then back to LOCAL or REMOTE position (If Alarm Reset Select is enabled).

**Compressor Alarm/Alert Circuit** — Each compressor is controlled by its own CPM processor, which closes contacts between plug terminals PL2-3 and PL2-6 to start the compressor. Power is supplied to the CPM logic circuit through each compressor high-pressure switch and into plug terminal PL2-2. If the high-pressure switch opens, the CPM generates an alarm.

**NOTE:** Similar connections for each compressor can be followed on the unit wiring diagrams located on the unit.

**Table 33 — Alarm and Alert Codes**

ALARM/ALERT CODE	ALARM OR ALERT	DESCRIPTION	WHY WAS THIS ALARM GENERATED?	ACTION TAKEN BY CONTROL	RESET METHOD	PROBABLE CAUSE		
0	—	No Alarms or Alerts Exist	—	—	—	—		
1.xx	See CPM subcodes below	Compressor A1 Failure	See CPM subcodes below	See CPM subcodes below	Manual	See CPM subcodes below		
2.xx	See CPM subcodes below	Compressor A2 Failure	See CPM subcodes below	See CPM subcodes below	Manual	See CPM subcodes below		
5.xx	See CPM subcodes below	Compressor B1 Failure	See CPM subcodes below	See CPM subcodes below	Manual	See CPM subcodes below		
6.xx	See CPM subcodes below	Compressor B2 Failure	See CPM subcodes below	See CPM subcodes below	Manual	See CPM subcodes below		
<b>CPM SUBCODES (xx)</b>								
x.0	—	No Error	—	—	—	—		
x.1	Alarm	High Pressure Switch Trip	HPS input to CPM module open	Comp. shut down	Manual/Button	Loss of condenser air/water flow. Operation beyond chiller capability. Liquid valve not open.		
x.2	Alarm	No Motor Current	CPM reads less than 10% of MTA on all legs for >3 seconds	Comp. shut down	Manual/Button	Power supply disconnected, blown fuse(s), wiring error, contactor not energized, faulty current toroid, motor overload tripped		
x.25*	Alarm	Current Imbalance >10% (Alarm)	CPM measures current balance between phases greater than 10% for 25 minutes	Circuit shut down	Manual/Button	Loose terminals on power wires. Poor power supply. Disabled only if alarm feature is enabled in <table border="1"><tr><td>3</td><td>SRVC</td></tr></table>	3	SRVC
3	SRVC							
x.27*	Alert	Current Imbalance >10% (Warning)	CPM measures current balance between phases greater than 10% for 25 minutes	None	—	Loose terminals on power wires. Poor power supply. Displayed only if alarm feature is disabled in <table border="1"><tr><td>3</td><td>SRVC</td></tr></table>	3	SRVC
3	SRVC							
x.3	Alarm	Current Imbalance >18%	CPM measures current balance between phases greater than 18% for 25 minutes	Circuit shut down	Manual/Button	Loose terminals on power wires. Poor power supply.		
x.35	Alarm	Single Phase Current Loss	CPM measures current imbalance between phases greater than 20%	Circuit shut down	Manual/Button	Blown fuse, wiring error, loose terminals.		
x.4	Alarm	High Motor Current	CPM detects high current compared to MTA setting	Comp. shut down	Manual/Button	Operation beyond chiller capability, improperly punched configuration header, blown fuse		
x.5	Alarm	Ground Fault	CPM detects ground current (2.5 ± 2.0 amps)	Comp. shut down	Manual/Button	Motor winding(s) gone to ground, wiring error, loose plug connector, current toroid plugs not facing same direction.		
x.55*	Alarm	Voltage Imbalance >3% (Alarm)	CPM measures voltage imbalance between phases greater than 3% for 25 minutes	Circuit shut down	Manual/Button	Compressor fault, local utility supply imbalance, Poor power supply. Displayed only if alarm feature is enabled in <table border="1"><tr><td>3</td><td>SRVC</td></tr></table>	3	SRVC
3	SRVC							
x.57*	Alert	Voltage Imbalance >3% (Warning)	CPM measures voltage imbalance between phases greater than 3% for 25 minutes	None	—	Compressor fault, local utility supply imbalance. Displayed only if alarm feature is disabled in <table border="1"><tr><td>3</td><td>SRVC</td></tr></table>	3	SRVC
3	SRVC							
x.6	Alarm	Voltage Imbalance >7%	CPM measures voltage imbalance between phases greater than 7% for 25 minutes	Circuit shut down	Manual/Button	Compressor fault, local utility supply imbalance		
x.7	Alarm	Volt Phase Reversal	CPM detects incoming power supply out of phase	Chiller shut down and not allowed to start	Manual/Button	Leads at CPM board not connected. Supply power not in phase; interchange any 2 incoming leads.		
x.75	Alarm	Contactor Failure	CPM detects min. 10% of MTA for 10 seconds after shutting off compressor contactor. Oil solenoid is energized.	All remaining compressors shut down. All loaders deenergized. Min. load valve of affected circuit energized (if equipped)	Manual/Button	Faulty contactor, contactor welded, wiring error.		
x.8	Alarm	Current Phase Reversal	CPM detects phase reversal from toroid reading	Circuit shut down	Manual/Button	Multiple terminal block power supply leads not in phase. Toroid wire harness crossed, toroid not all facing same direction		

**Table 33 — Alarm and Alert Codes (cont)**

ALARM/ALERT CODE	ALARM OR ALERT	DESCRIPTION	WHY WAS THIS ALARM GENERATED?	ACTION TAKEN BY CONTROL	RESET METHOD	PROBABLE CAUSE
<b>CPM SUBCODES (xx)</b>						
<b>x.85</b>	Alarm	Motor Over Temperature	CPM detects high motor temperature	Comp. shut down	Manual/Button	Motor cooling (all) or Economizer (2 comp. circuits) solenoid failure, low refrigerant charge.
<b>x.9</b>	Alarm	Open Thermistor	CPM detects open circuit in motor temp thermistor	Comp. shut down	Manual/Button	Wiring error or faulty thermistor.†
<b>x.95</b>	Alarm	Config. Header Fault	CPM finds error with MTA value punched out in header	Comp. shut down	Manual/Button	Header pins on CPM board either all or none punched out, header not fully seated in CPM board.
<b>x.10</b>	Alarm	Shorted Thermistor	CPM detects short circuit in motor temp thermistor	Comp. shut down	Manual/Button	Wiring error or faulty thermistor.†
<b>ALARM/ALERT CODE</b>						
<b>7</b>	Alert	Cir. A Discharge Gas Thermistor Failure	Thermistor outside range of -40 to 245 F (-40 to 118 C) or DGT >210 F (98.9 C)	Circuit A shut down	Manual	Thermistor failure, motor cooling solenoid failure or wiring error.
<b>8</b>	Alert	Cir. B Discharge Gas Thermistor Failure	Thermistor outside range of -40 to 245 F (-40 to 118 C) or DGT >210 F (98.9 C)	Circuit B shut down	Manual	Thermistor failure, motor cooling solenoid failure or wiring error.
<b>9</b>	Alarm	Cooler Leaving Fluid Thermistor Failure	Thermistor outside range of -40 to 245 F (-40 to 118 C)	Chiller shut down.	Automatic	Thermistor failure, damaged cable/wire or wiring error.
<b>10</b>	Alarm	Cooler Entering Fluid Thermistor Failure	Thermistor outside range of -40 to 245 F (-40 to 118 C).	Uses 0.1° F/% Total Capacity as rise/ton.	Automatic	Thermistor failure, damaged cable/wire or wiring error.
<b>11</b>	Alert	Condenser Leaving Fluid Thermistor Failure	Thermistor outside range of -40 to 245 F (-40 to 118 C)	None. Chiller continues to run.	Automatic	Thermistor failure, damaged cable/wire or wiring error.
<b>12</b>	Alert	Condenser Entering Fluid Thermistor Failure	Thermistor outside range of -40 to 245 F (-40 to 118 C)	None. Chiller continues to run.	Automatic	Thermistor failure, damaged cable/wire or wiring error.
<b>15</b>	Alert	Compressor A1 High Motor Temperature	Thermistor outside range of -39.9 to 245 F (-39.9 to 118 C) for 5 consecutive readings	Compressor A1 shut down	Manual	Thermistor failure, motor cooling (all) or Economizer (2 comp. circuits) solenoid failure.
<b>16</b>	Alert	Compressor A2 High Motor Temperature	Thermistor outside range of -39.9 to 245 F (-39.9 to 118 C) for 5 consecutive readings	Compressor A2 shut down	Manual	Thermistor failure, motor cooling (all) or Economizer (2 comp. circuits) solenoid failure.
<b>17</b>	Alert	Compressor B1 High Motor Temperature	Thermistor outside range of -39.9 to 245 F (-39.9 to 118 C) for 5 consecutive readings	Compressor B1 shut down	Manual	Thermistor failure, motor cooling (all) or Economizer (2 comp. circuits) solenoid failure.
<b>18</b>	Alert	Compressor B2 High Motor Temperature	Thermistor outside range of -39.9 to 245 F (-39.9 to 118 C) for 5 consecutive readings	Compressor B2 shut down	Manual	Thermistor failure, motor cooling (all) or Economizer (2 comp. circuits) solenoid failure.
<b>21</b>	Alert	External Reset Temperature Thermistor Failure	Thermistor outside range of -40 to 245 F (-40 to 118 C)	Reset disabled. Runs under normal control/set points.	Automatic	Thermistor failure or wiring error.
<b>22</b>	Alert	Circuit A Discharge Pressure Transducer Failure	Calibration offset more than 6 PSIG or Voltage ratio (volts read/ref. voltage) more than 99.9% or less than 0.5%.	Circuit A shut down	Automatic	Transducer failure, power supply failure or wiring damage/error.
<b>23</b>	Alert	Circuit B Discharge Pressure Transducer Failure	Calibration offset more than 6 PSIG or Voltage ratio (volts read/ref. voltage) more than 99.9% or less than 0.5%.	Circuit B shut down	Automatic	Transducer failure, power supply failure or wiring damage/error.
<b>24</b>	Alert	Circuit A Suction Pressure Transducer Failure	Calibration offset more than 6 PSIG or Voltage ratio (volts read/ref. voltage) more than 99.9% or less than 0.5%.	Circuit A shut down	Automatic	Transducer failure, power supply failure or wiring damage/error.
<b>25</b>	Alert	Circuit B Suction Pressure Transducer Failure	Calibration offset more than 6 PSIG or Voltage ratio (volts read/ref. voltage) more than 99.9% or less than 0.5%.	Circuit B shut down	Automatic	Transducer failure, power supply failure or wiring damage/error.
<b>26</b>	Alert	Comp A1 Oil Pressure Transducer Failure	Calibration offset more than 6 PSIG or Voltage ratio (volts read/ref. voltage) more than 99.9% or less than 0.5%.	Comp A1 shut down	Automatic	Transducer failure, power supply failure or wiring damage/error.
<b>27</b>	Alert	Comp A2 Oil Pressure Transducer Failure	Calibration offset more than 6 PSIG or Voltage ratio (volts read/ref. voltage) more than 99.9% or less than 0.5%.	Comp A2 shut down	Automatic	Transducer failure, power supply failure or wiring damage/error.

**Table 33 — Alarm and Alert Codes (cont)**

ALARM/ALERT CODE	ALARM OR ALERT	DESCRIPTION	WHY WAS THIS ALARM GENERATED?	ACTION TAKEN BY CONTROL	RESET METHOD	PROBABLE CAUSE
28	Alert	Comp B1 Oil Pressure Transducer Failure	Calibration offset more than 6 PSIG or Voltage ratio (volts read/ref. voltage) more than 99.9% or less than 0.5%.	Comp B1 shut down	Automatic	Transducer failure, power supply failure or wiring damage/error.
29	Alert	Comp B2 Oil Pressure Transducer Failure	Calibration offset more than 6 PSIG or Voltage ratio (volts read/ref. voltage) more than 99.9% or less than 0.5%.	Comp B2 shut down	Automatic	Transducer failure, power supply failure or wiring damage/error.
30	Alert	Circuit A Economizer Transducer Failure	Calibration offset more than 6 PSIG or Voltage ratio (volts read/ref. voltage) more than 99.9% or less than 0.5%.	Circuit A shut down	Automatic	Transducer failure, power supply failure or wiring damage/error.
31	Alert	Circuit B Economizer Transducer Failure	Calibration offset more than 6 PSIG or Voltage ratio (volts read/ref. voltage) more than 99.9% or less than 0.5%.	Circuit B shut down	Automatic	Transducer failure, power supply failure or wiring damage/error.
32	Alarm	Transducer Supply Outside 4.5 to 5.5 Volts	Reference voltage measured at PSIO-1, J7-34,35 less than 4.5 V or greater than 5.5 V.	Chiller shut down	Automatic	Power supply failure or wiring error. Low transformer voltage.
34	Alert	4-20 mA Reset Input Out of Range	If configured and input signal to PSIO-2, J7-19,20(HX), J7-22,23(GX) less than 2 mA or greater than 20 mA	Reset function disabled. Normal set point used	Automatic	Faulty signal generator, wiring error, 500 ohm resistor missing or not properly installed.
35	Alert	4-20 mA Demand Limit Input Out of Range	If configured and input signal to PSIO-2, J7-22,23(HX), J7-13,14(GX) less than 2 mA or greater than 20 mA	Demand limit ignored. Runs under normal control based on 100% demand limit.	Automatic	Faulty signal generator, wiring error, 500 ohm resistor missing or not properly installed.
36	Alarm	Loss of Communication with "Hardware Point"	PSIO-1 has lost communication with one of the points in Table 34.	See Table 34.	Automatic	Failed module, wiring error, failed transformer, loose connection plug, wrong address
37	Alert	Circuit A Low Saturated Suction Temperature	SST reads 6 F (3.3 C) or more below the freeze point for 3 minutes. Point is 28 F (-2.2 C) for water, set point minus 8 F (4.4 C) for brines.	Circuit A shut down	Manual	Low refrigerant charge, plugged strainer, faulty expansion valve. Low water flow.
38	Alert	Circuit B Low Saturated Suction Temperature	SST reads 6 F (3.3 C) or more below the freeze point for 3 minutes. Point is 30 F (-1.1 C) for water, cooling set point minus 8 F (4.4 C) for brines.	Circuit B shut down	Manual	Low refrigerant charge, plugged strainer, faulty expansion valve. Low water flow.
40	Alert	Compressor A1 Low Oil Pressure	See Note 1.	Comp A1 shut down	Manual	Low Water Temperature, low refrigerant charge, plugged oil filter, closed oil valve, bad oil solenoid, compressor oil check valve stuck, oil line check valve stuck, plugged oil strainer.
41	Alert	Compressor A2 Low Oil Pressure	See Note 1.	Comp A2 shut down	Manual	Low Water Temperature, low refrigerant charge, plugged oil filter, closed oil valve, bad oil solenoid, compressor oil check valve stuck, oil line check valve stuck, plugged oil strainer.
42	Alert	Compressor B1 Low Oil Pressure	See Note 1.	Comp B1 shut down	Manual	Low Water Temperature, low refrigerant charge, plugged oil filter, closed oil valve, bad oil solenoid, compressor oil check valve stuck, oil line check valve stuck, plugged oil strainer.
43	Alert	Compressor B2 Low Oil Pressure	See Note 1.	Comp B2 shut down	Manual	Low Water Temperature, low refrigerant charge, plugged oil filter, closed oil valve, bad oil solenoid, compressor oil check valve stuck, oil line check valve stuck, plugged oil strainer.
44	Alarm	Circuit A Condenser Freeze Protection (alarm ignored for brine chillers)	For W/C chillers only, if SCT <34 F (1.1 C)	Chiller shut down. Turn Cond pump On if Chiller is Off	Automatic	Failed/bad discharge pressure transducer, refrigerant leak, configured for water-cooled condenser

**Table 33 — Alarm and Alert Codes (cont)**

ALARM/ALERT CODE	ALARM OR ALERT	DESCRIPTION	WHY WAS THIS ALARM GENERATED?	ACTION TAKEN BY CONTROL	RESET METHOD	PROBABLE CAUSE
45	Alarm	Circuit B Condenser Freeze Protection (alarm ignored for brine chillers)	For W/C chillers only , if SCT <34 F (1.1 C)	Chiller shut down. Turn Cond pump On if Chiller is Off	Automatic	Failed/bad discharge pressure transducer, refrigerant leak, configured for water-cooled condenser
46	Alarm	Cooler Freeze Protection	Cooler EWT or LWT less than freeze point. Freeze point is 34 F (1.1 C) for water, cooling set point minus 8 F (4.4 C) for brines.	Chiller shut down. Leave Cooler pump on. Turn Cooler pump On if Chiller is Off.	Automatic**	Faulty thermistor, low water flow
47	Alert	Circuit A High Saturated Suction Temperature	After first 90 seconds, SST > 55 F (12.8 C) and EXV < 1% for 5 minutes	Circuit A shut down	Manual	Faulty expansion valve, liquid level sensor or transducer.
48	Alert	Circuit B High Saturated Suction Temperature	After first 90 seconds, SST > 55 F (12.8 C) and EXV < 1% for 5 minutes	Circuit B shut down	Manual	Faulty expansion valve, liquid level sensor or transducer.
49	Alarm	Loss of Condenser Flow	Flow switch not closed within 1 minute after pump is started or if flow switch opens during normal operation for >10 seconds	Chiller shut down	Manual	Low condenser water flow, failed condenser pump
50	Alarm	Illegal Configuration x	Illegal Configuration has been entered. Correction needed.	Chiller cannot start. See Table 35.	Manual	Configuration error.
51	Alarm	Initial Configuration Required	No configuration has been entered.	Chiller cannot start	Manual	Configuration omitted.
52	Alarm	Unit is in Emergency Stop	CCN command received to shut unit down.	Chiller shut down	CCN/ Automatic	Network command.
53	Alarm	Cooler Pump Interlock Failed at Start-Up	Interlock did not close within 1 minute after transition	Chiller shut down. Pump turned off.	Automatic	Failure of cooler pump or controls
54	Alarm	Cooler Pump Interlock Opened Unexpectedly	Interlock opened for at least 5 seconds during operation	Chiller shut down. Pump turned off.	Automatic	Failure of cooler pump or controls
55	Alarm	Cooler Pump Interlock Closed When Pump OFF	Interlock closed when pump relay is off	Cooler pump remains off. Unit prevented from starting.	Manual	Failure of cooler pump relay or interlock, welded contacts
56	Alert	Loss of Communication with WSM	No communications have been received by PSIO-1 within 5 minutes of last transmission.	WSM forces removed. Runs under own control	Automatic	Failed module, wiring error, failed transformer, loose connection plug, wrong address
57	Alert	Circuit A Liquid Level Sensor Failure	Sensor reads 245 F (118 C) or -40 F (-40 C) with SST > 9 F (-12.8 C)	Runs, but controls EXV based on Disch. Superheat	Automatic	Thermistor circuit open, faulty liquid level sensor, wiring error
58	Alert	Circuit B Liquid Level Sensor Failure	Sensor reads 245 F (118 C) or -40 F (-40 C) with SST > 9 F (-12.8 C)	Runs, but controls EXV based on Disch. Superheat	Automatic	Thermistor circuit open, faulty liquid level sensor, wiring error
59	Alarm	Compressor A1 Pre-Start Oil Pressure	Oil Pump did not build sufficient pressure during pre-lube cycle.	Circuit cannot start	Manual	Low oil, oil pump failure, oil solenoid failure, oil transducer failure, check valve failed open, oil shutoff valve closed
60	Alarm	Compressor A2 Pre-Start Oil Pressure	Oil Pump did not build sufficient pressure during pre-lube cycle.	Circuit cannot start	Manual	Low oil, oil pump failure, oil solenoid failure, oil transducer failure, check valve failed open, oil shutoff valve closed
61	Alarm	Compressor B1 Pre-Start Oil Pressure	Oil Pump did not build sufficient pressure during pre-lube cycle.	Circuit cannot start	Manual	Low oil, oil pump failure, oil solenoid failure, oil transducer failure, check valve failed open, oil shutoff valve closed
62	Alarm	Compressor B2 Pre-Start Oil Pressure	Oil Pump did not build sufficient pressure during pre-lube cycle.	Circuit cannot start	Manual	Low oil, oil pump failure, oil solenoid failure, oil transducer failure, check valve failed open, oil shutoff valve closed
63	Alarm	Circuit A&B OFF for Alerts. Unit down	Control has shut down both circuits due to alerts.	None	Automatic	Check individual alarms
64	Alert	Circuit A Loss of Charge	Discharge pressure reading <10 PSIG for 30 seconds	Circuit A shut down	Manual	Refrigerant leak or transducer failure
65	Alert	Circuit B Loss of Charge	Discharge pressure reading <10 PSIG for 30 seconds	Circuit B shut down	Manual	
66	Alarm	Loss of Communication with FSM	No communications have been received by PSIO-1 within 5 minutes of last transmission.	FSM forces removed Runs under own control	Automatic	Wiring faulty or module failure
67	Alert	Circuit A High Discharge Pressure	SCT > MCT_SP + 5 F (2.8 C)	Circuit shut down	Automatic**	Faulty transducer/high pressure switch, low/restricted condenser air/water flow.††

**Table 33 — Alarm and Alert Codes (cont)**

ALARM/ALERT CODE	ALARM OR ALERT	DESCRIPTION	WHY WAS THIS ALARM GENERATED?	ACTION TAKEN BY CONTROL	RESET METHOD	PROBABLE CAUSE
68	Alert	Circuit B High Discharge Pressure	SCT > MCT_SP + 5 F (2.8 C)	Circuit shut down	Automatic**	Faulty transducer/high pressure switch, low/restricted condenser air/water flow.††
70	Alert	High Leaving Chilled Water Temperature	LCW read > LCW Delta Alarm limit and total capacity is 100% and current LCW > LCW reading 1 minute ago	Alert only. None	Automatic	Building load greater than unit capacity, low water/brine flow, or compressor fault. Check for other alarms or alerts.
71	Alert	Circuit A Low Oil Level	Level switch input open for 4th time in same day.	Circuit A shut down	Manual	Low oil level, failed switch, wiring error, failed DSIO module
72	Alert	Circuit B Low Oil Level	Level switch input open for 4th in same day.	Circuit B shut down	Manual	Low oil level, failed switch, wiring error, failed DSIO module
73	Alert	Circuit A Low Discharge Superheat	Superheat <5 F (2.8 C) for 10 minutes	Circuit A shut down	Manual	Faulty thermistor, transducer or EXV or Economizer. Motor cooling solenoid stuck open.
74	Alert	Circuit B Low Discharge Superheat	Superheat <5 F (2.8 C) for 10 minutes	Circuit B shut down	Manual	Faulty thermistor, transducer or EXV or Economizer. Motor cooling solenoid stuck open.
75	Alarm	Comp. A1 Max. Oil Delta P, check oil line	(Discharge press – Oil press) >100 PSI for more than 5 seconds	Comp. A1 shut down	Manual	Plugged oil filter, closed oil valve, bad oil solenoid, compressor oil check valve stuck, oil line check valve stuck, plugged oil strainer
76	Alarm	Comp. A2 Max. Oil Delta P, check oil line	(Discharge press – Oil press) >100 PSI for more than 5 seconds	Comp. A2 shut down	Manual	Plugged oil filter, closed oil valve, bad oil solenoid, compressor oil check valve stuck, oil line check valve stuck, plugged oil strainer
77	Alarm	Comp. B1 Max. Oil Delta P, check oil line	(Discharge press – Oil press) >100 PSI for more than 5 seconds	Comp. B1 shut down	Manual	Plugged oil filter, closed oil valve, bad oil solenoid, compressor oil check valve stuck, oil line check valve stuck, plugged oil strainer
78	Alarm	Comp. B2 Max. Oil Delta P, check oil line	(Discharge press – Oil press) >100 PSI for more than 5 seconds	Comp. B2 shut down	Manual	Plugged oil filter, closed oil valve, bad oil solenoid, compressor oil check valve stuck, oil line check valve stuck, plugged oil strainer
79	Alarm	Comp. A1 Failed Oil Solenoid	Diff. Oil pressure >2.5 PSI during period after oil pump starts and before oil solenoid opens	Comp. A1 not allowed to start	Manual	Faulty oil solenoid valve
80	Alarm	Comp. A2 Failed Oil Solenoid	Diff. Oil pressure >2.5 PSI during period after oil pump starts and before oil solenoid opens	Comp. A2 not allowed to start	Manual	Faulty oil solenoid valve
81	Alarm	Comp. B1 Failed Oil Solenoid	Diff. Oil pressure >2.5 PSI during period after oil pump starts and before oil solenoid opens	Comp. B1 not allowed to start	Manual	Faulty oil solenoid valve
82	Alarm	Comp. B2 Failed Oil Solenoid	Diff. Oil pressure >2.5 PSI during period after oil pump starts and before oil solenoid opens	Comp. B2 not allowed to start	Manual	Faulty oil solenoid valve

**LEGEND**

- CCN — Carrier Comfort Network
- CPM — Compressor Protection Module
- DGT — Discharge Gas Temperature
- EWT — Entering Water Temperature
- EXV — Electronic Expansion Valve
- FSM — Flotronic™ System Manager
- HPS — High-Pressure Switch
- LCW — Leaving Chilled Water
- LWT — Leaving Water Temperature
- MCT\_SP — Maximum Condensing Temperature Set Point
- MTA — Compressor Must Trip Amps
- SCT — Saturated Condensing Temperature
- SST — Saturated Suction Temperature
- W/C — Water-Cooled
- WSM — Water System Manager

**NOTES:**

1. Low Oil Pressure Alert Criteria and Set Points  
 Where: P<sub>d</sub> = Discharge pressure, P<sub>s</sub> = Suction pressure,  
 P<sub>o</sub> = Oil pressure and P<sub>e</sub> = Economizer pressure  
 Two oil pressure set points are used. Oil Set point 1 is always 15 psig.  
 a. If (P<sub>d</sub> – P<sub>s</sub>) < 125, then Oil Set point 2 = 0.235 x (P<sub>d</sub> – P<sub>s</sub>) + 0.588  
 b. If (P<sub>d</sub> – P<sub>s</sub>) ≥ 125 and < 165, then Oil Set point 2 = 2.0 x (P<sub>d</sub> – P<sub>s</sub>) – 220.0  
 c. If (P<sub>d</sub> – P<sub>s</sub>) ≥ 165, then Oil Set point 2 = 0.6364 x (P<sub>d</sub> – P<sub>s</sub>) + 5.0  
 The 2 set points are used by the control for the Low Oil Pressure alert trip criteria below:  
 a. Oil Pressure is ignored during the first 5 seconds after a compressor is started.  
 b. In period between 5 and 30 seconds after starting, the alert will be generated if (P<sub>o</sub> – P<sub>e</sub>) < [(Oil Set point 1)/30] x (Compressor Run time in seconds) for 3 consecutive readings  
 c. After 30 seconds run time, the alert will be generated if:  
 1) (P<sub>o</sub> – P<sub>e</sub>) < Oil Set point 1 for 15 seconds OR  
 2) (P<sub>o</sub> – P<sub>s</sub>) < Oil Set point 2 for 25 seconds
2. (P<sub>o</sub> – P<sub>e</sub>) is the Oil pressure differential displayed in 3 STAT for Circuit A and 5 STAT for Circuit B.

\*Current and voltage imbalance alarms x.25 and x.55 may be changed to warnings x.27 and x.57 after successful start-up of the chiller.

†Compressors are equipped with 2 motor winding temperature thermistors. Verify first that the problem is not a wiring error before using backup thermistor.

\*\*Reset automatic first time, manual if repeated on the same date.

††Note that the high-pressure switch should trip before this alert is generated. Check HPS operation if this alert is generated.



**Table 34 — Hardware Point Communications Loss/Action Taken**

HARDWARE POINT	CONTROL POINT NAME	ACTION TAKEN UNTIL COMMUNICATION RESTORED
ALARM	Alarm Relay	No Action
CFLOW_SW	Cooler Flow Switch	Chiller shut down
COND_ENT	Condenser Entering Water Thermistor	Same as Alert 12
COND_LWT	Condenser Leaving Water Thermistor	Same as Alert 11
COND_PMP	Condenser Pump Relay	Chiller shut down
COOL_EWT	Cooler Entering Water Thermistor	Same as Alarm 10
COOL_LWT	Cooler Leaving Water Thermistor	Chiller shut down
COOL_HTR	Cooler Heater	Turn ON Cooler Pump relay
COOL_PMP	Cooler Pump Relay	No Action
DFLOW_SW	Condenser Flow Switch	Chiller shut down
DISTMP_A	Discharge Gas Temp Circuit A (Oil Temp)	Circuit shut down
DISTMP_B	Discharge Gas Temp Circuit A (Oil Temp)	Circuit shut down
DISTMP_B	Discharge Gas Temp Circuit B (Oil Temp)	Circuit shut down
DMD_SW1	Demand Limit Switch 1	No Action
DMD_SW2	Demand Limit Switch 2	No Action
DPA	Discharge Pressure Circuit A	Circuit shut down
DPB	Discharge Pressure Circuit B	Circuit shut down
DUAL	Dual Setpoint Switch	Control to Setpoint 1
ECN_PR_A	Circuit A Economizer Pressure	Circuit shut down
ECN_PR_B	Circuit B Economizer Pressure	Circuit shut down
EXVA	Expansion Valve, Circuit A	Circuit shut down
EXVB	Expansion Valve, Circuit B	Circuit shut down
FAN_1	Fan Relay 1	No Action
FAN_2	Fan Relay 2	No Action
FAN_3	Fan Relay 3	No Action
FAN_4	Fan Relay 4	No Action
FAN_5	Fan Relay 5	No Action
FAN_6	Fan Relay 6	No Action
HC_SW	Heat/Cool Switch	Chiller shut down
HR_EWT	Heat Reclaim Entering Water Thermistor	No Action
HR_LWT	Heat Reclaim Leaving Water Thermistor	No Action
ICE_DONE	Ice Complete Indicator	Disable function
ICE_VALV	Ice Valve	Disable function
K_A1_FBK	Compressor A1 Feedback	Compressor shut down
K_A1_RLY	Compressor A1 Relay	Compressor shut down
K_A2_FBK	Compressor A2 Feedback	Compressor shut down
K_A2_RLY	Compressor A2 Relay	Compressor shut down
K_B1_FBK	Compressor B1 Feedback	Compressor shut down
K_B1_RLY	Compressor B1 Relay	Compressor shut down
K_B2_FBK	Compressor B2 Feedback	Compressor shut down
K_B2_RLY	Compressor B2 Relay	Compressor shut down
LOADR_A1	Compressor A1 Loader	No Action
LOADR_A2	Compressor A2 Loader	No Action
LOADR_B1	Compressor B1 Loader	No Action
LOADR_B2	Compressor B2 Loader	No Action
LMT_MA	Demand Limit 4-20 mA Input	Disable function
LOR_SW	Local/Off/Remote Switch	Chiller shut down
MLV_A	Min. Load Valve Relay Circuit A	Disable function
MLV_B	Min. Load Valve Relay Circuit B	Disable function
MOTOR_A	Circuit A Motormaster® Output	Disable function
MOTOR_B	Circuit B Motormaster Output	Disable function
MTRCL_A1	Compressor A1 Motor Cooling	Compressor shut down
MTRCL_A2	Compressor A2 Motor Cooling	Compressor shut down
MTRCL_B1	Compressor B1 Motor Cooling	Compressor shut down
MTRCL_B2	Compressor B2 Motor Cooling	Compressor shut down
OAT	Outside Air Temperature	Disable function
OIL_A1	Compressor A1 Oil Pressure Transducer	Compressor shut down
OIL_A2	Compressor A2 Oil Pressure Transducer	Compressor shut down
OIL_B1	Compressor B1 Oil Pressure Transducer	Compressor shut down
OIL_B2	Compressor B2 Oil Pressure Transducer	Compressor shut down
OILA_HTR	Circuit A Oil Heater	Disable function
OILA_SW	Circuit A Oil Level	Circuit shut down
OILB_HTR	Circuit B Oil Heater	Disable function
OILB_SW	Circuit B Oil Level	Circuit shut down
OILPMP_A	Circuit A Oil Pump	No Action
OILPMP_B	Circuit B Oil Pump	No Action
OILSOL_A	Circuit A Oil Solenoid	Circuit shut down
OILSOL_B	Circuit B Oil Solenoid	Circuit shut down
P_REF	5 Volt Transducer Reference	Chiller shut down
RALARMx	Remote Alarm Relay x (1-16)	Disable function
RST_MA	Temp. Reset 4-20 mA signal	Disable function
SPA	Circuit A Suction Transducer	Circuit shut down
SPB	Circuit B Suction Transducer	Circuit shut down
TLEV_A	Circuit A Cooler Level Sensor	Control EXV-A by discharge superheat
TLEV_B	Circuit B Cooler Level Sensor	Control EXV-B by discharge superheat
TMTR_A1	Compressor A1 Motor Thermistor	Compressor shut down
TMTR_A2	Compressor A2 Motor Thermistor	Compressor shut down
TMTR_B1	Compressor B1 Motor Thermistor	Compressor shut down
TMTR_B2	Compressor B2 Motor Thermistor	Compressor shut down
T_SPACE	External Space Temp Thermistor	Disable function
VALVE_A	Circuit A Water Valve Control	Circuit shut down
VALVE_B	Circuit B Water Valve Control	Circuit shut down

**Table 35 — Illegal Configurations Recognized by PSIO-1**

CODE NUMBER	ILLEGAL CONFIGURATION DESCRIPTION
1	Incorrect Check Sum in configuration code (factory or service code)
2	Unit type outside range of (1-3)
3	Number of compressors in a circuit outside the range of 0-2
4	Air cooled chiller with a fan type outside the range of 1-16
5	Air cooled chiller with Low Temperature Brine fluid
6	Water cooled chiller configured for air cooled head pressure
7	Selecting both OAT and Space Temp sensors for External Reset operation
8	Air cooled chiller with condenser water pump
9	Air cooled chiller with condenser thermistors
10	MOP Set point is outside the range of 40 - 55 F (4.4 - 12.8 C)
11	Maximum Condensing Temperature Set point (MCT_SP) is outside the range of 0 - 158 F (-17.8 - 70 C)

**LEGEND**

**MOP** — Minimum Operating Temperature  
**OAT** — Outdoor-Air Temperature

**EXD Troubleshooting Procedure** — Follow steps below to diagnose and correct EXV/Economizer problems.

On 30HX units with economizers, verify that the valve for the bubbler tube (bottom of economizer) is open. Check EXV motor operation first. Press **4** **TEST** on the HSIO II keypad and select the appropriate EXV. Press **1** **ENTR** to move the valve to 25%. You should be able to feel the actuator moving by placing your hand on the EXV or economizer body (the actuator is located about one-half to two-thirds of the way up from the bottom of the economizer shell). Press **1** **ENTR** three more times until the display reads 100% for a Target Percent (waiting until actuator stops each time). A hard knocking should be felt from the actuator when

it reaches the top of its stroke (can be heard if surroundings are relatively quiet). Press **1** **ENTR** again if necessary to confirm this. Press **0** **ENTR** four times to step the actuator closed in 25% increments, waiting again in between each move. The actuator should knock when it reaches the bottom of its stroke. If it is believed that the valve is not working properly, continue with the checkout procedure below:

Check the EXV output signals at appropriate terminals on EXV driver module (see Fig. 12). Connect positive test lead to terminal 1 on the EXV driver for Circuit A and to terminal 7 for Circuit B. Set meter for approximately 20 vdc. Enter Valves and Motor Master test subfunction by pressing **4** **TEST** on the HSIO. The EXV for Circuit A will be displayed; if desired, press the down arrow key for Circuit B.

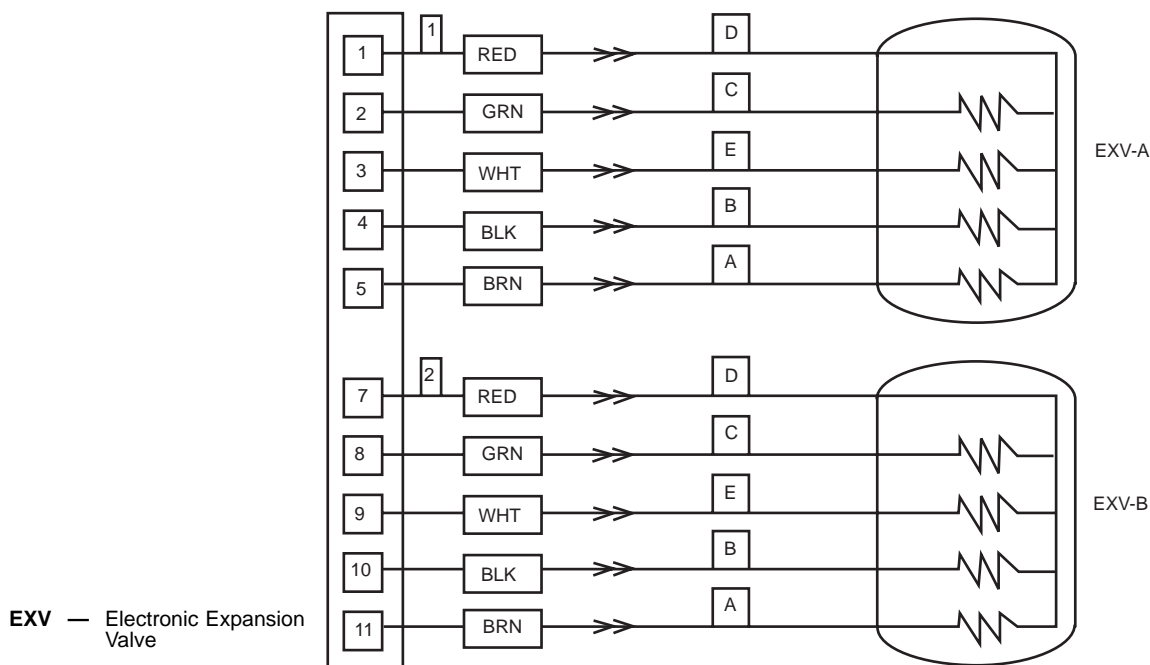
When at the desired valve, press **1** **ENTR**. The display should change to show a Target Percent of 25%. The driver should drive the circuit EXV under test. During the next several seconds, connect negative test lead to pins 2, 3, 4, and 5 in succession (pins 8, 9, 10 and 11 for Circuit B). Voltage should rise and fall at each pin. If it remains constant at a voltage or shows 0 volts, remove the connector to the valve and recheck.

Press **0** **ENTR** to close the circuit EXV. Check the DSIO address setting (the address should be 50). If a problem still exists, replace the EXV driver module. If the voltage reading is correct, the expansion valve and EXV wiring should be checked. Check the EXV terminal strip and interconnecting wiring.

1. Check color coding and wire connections. Make sure they are connected to the correct terminals at the EXV driver and EXV plug and that the cables are not crossed.
2. Check for continuity and tight connection at all pin terminals.

Check the resistance of the EXV motor windings. Remove the DSIO-EXV plug J4 terminal strip and check the resistance between the common lead (red wire, terminal D) and remaining leads, A, B, C, and E (see Fig. 12). The resistance should be 25 ohms ± 2 ohms.

EXV DRIVER BOARD, J4



**Fig. 12 — EXV Cable Connections to EXV Driver Module, DSIO-EXV**

## INSPECTING/OPENING ELECTRONIC EXPANSION VALVES

**IMPORTANT:** Obtain replacement O-ring before opening EXV. Do not reuse O-rings.

To check the physical operation of an EXV, the following steps must be performed:

1. Close the liquid line service valve of the circuit to be checked. Put the LOR switch in the OFF position. Using the HSIO, enter the manual service mode by pressing **8** **SRVC**. Enable the mode by pressing **1** **ENTR**. Switch the LOR switch to the Local position. Scroll down to the desired compressor and press **1** **ENTR** to turn it on. Let compressor run until gage on suction pressure port reads between 5 and 10 psig. Press **0** **ENTR** to turn the compressor off. Immediately after the compressor shuts off, close the discharge valve.
2. Remove any remaining refrigerant from the system low side using proper reclaiming techniques. Drain oil from cooler using Schrader port in cooler inlet line. Turn off the line voltage power supply to the compressors and control circuit power.
3. Remove screws holding top cover of EXV. Carefully remove the top cover from the EXV making sure EXV plug is still connected.

**IMPORTANT:** When removing top cover from EXVs, be careful to avoid damage to motor leads.

4. Enter the appropriate EXV test step for EXV-A or EXV-B by pressing **4** **TEST** on the HSIO. Scroll down to display the desired EXV. Press **1** and **ENTR** to initiate the test. Observe the operation of the valve motor and lead screw. The motor should turn counterclockwise, and the lead screw should move up out of the motor hub until the valve is fully open. Lead screw movement should be smooth and uniform from fully closed to fully open position. Press **1** **ENTR** as needed to reach 100% open. Wait 30 seconds in between each step for motor to stop moving. Press **0** **ENTR** to check open to closed operation. If the valve is properly connected to the processor and receiving correct signals, yet does not operate as described above, the valve should be replaced.

**INSPECTING/OPENING ECONOMIZERS** — To check the physical operation of an economizer (see Fig. 13), the following steps must be performed:

1. Close the liquid line service valve of the circuit to be checked. Put the LOR switch in the OFF position. Using the HSIO, enter the manual service mode by pressing **8** **SRVC**. Enable the mode by pressing **1** **ENTR**. Switch the LOR switch to the Local position. Scroll down to the desired compressor and press **1** **ENTR** to turn it on. Let compressor run until gage on suction pressure port reads between 5 and 10 psig. Press **0** **ENTR** to turn the compressor off. Immediately after the compressor shuts off, close the discharge valve and the bubbler valve on 30HX units (located in elbow fitting on condenser shell).

2. Remove any remaining refrigerant from the system low side and discharge piping using proper reclaiming techniques. For 30GX units, there is no shutoff valve in the bubbler tube line. Drain oil from cooler using Schrader port in cooler inlet line. Turn off the line voltage power supply to the compressors and control circuit power.
3. Remove the shell retaining bolts on the bottom of the economizer and the bolts that secure the shell to the unit frame or mounting bracket. Cut the motor cooling line leaving the top of the economizer. Carefully remove the shell from the economizer. Make sure EXV plug is still connected.

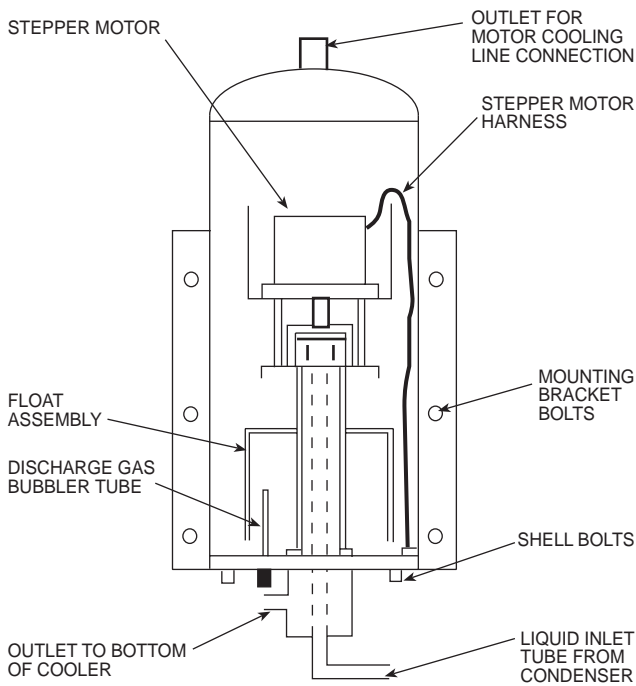
**IMPORTANT:** When removing shell from economizer, it must be lifted off as close to vertical as possible to prevent damage to any of the internal parts. Use a catch pan beneath the economizer as oil will come out when the shell is removed. Be careful to avoid damage to motor leads.

4. Enter the appropriate EXV test step for EXV-A or EXV-B by pressing **4** **TEST** on the HSIO. Scroll down to display the desired EXV. Press **1** and **ENTR** to initiate the test. Observe the operation of the valve motor and lead screw. The motor should turn counterclockwise, and the lead screw should move up out of the motor hub until the valve is fully open. Lead screw movement should be smooth and uniform from fully closed to fully open position. Press **1** **ENTR** as needed to reach 100% open. Wait 30 seconds in between each step for motor to stop moving. Press **0** **ENTR** to check open to closed operation. If the valve is properly connected to the processor and receiving correct signals, yet does not operate as described above, the economizer should be replaced.
5. Additional items to check for:
  - a. Verify that float assembly (see cross section view in Fig. 13) moves up and down freely. It should take only a minimal force (less than one pound) to move the float and there should be no binding.
  - b. Check the bubbler tube (found by carefully lifting the float) for crimps, etc. and verify that the end of the tube is open.
6. Reassemble economizer; retorque shell retaining bolts to 35 ft-lb (48 N-m).

If operating problems persist after reassembly, they may be due to a bad liquid level sensor, suction pressure transducer or intermittent connections between the processor board terminals and EXV plug. Recheck all wiring connections and voltage signals.

Other possible causes of improper refrigerant flow control could be restrictions in the liquid line. Check for plugged strainer(s) or restricted metering slots in the EXV or economizer. Formation of ice or frost on lower body of electronic expansion valve is one symptom of restricted metering slots. However, frost or ice formation is normally expected when leaving fluid temperature from the cooler is below 40 F. Clean or replace valve if necessary.

**NOTE (non-economizer units only):** Frosting of valve is normal during compressor test steps and at initial start-up. Frost should dissipate after 5 to 10 minutes operation in a system that is operating properly. If valve is to be replaced, wrap valve with a wet cloth to prevent excessive heat from damaging internal components.

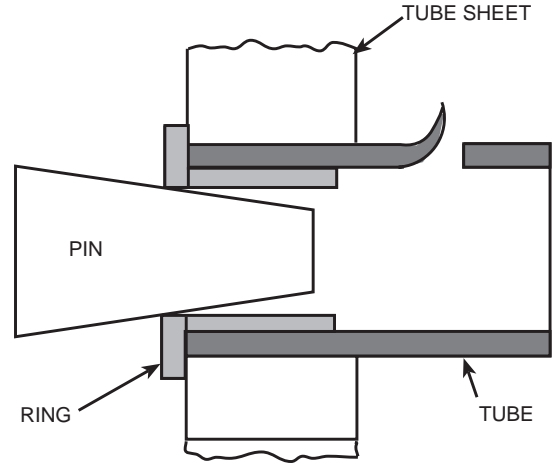
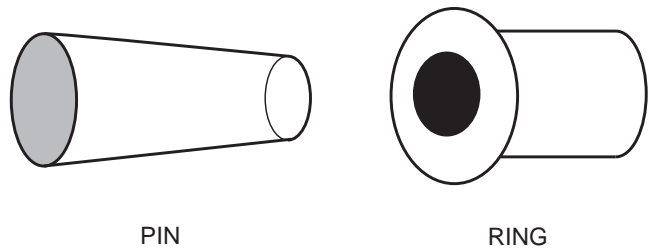


**Fig. 13 — 30GX,HX Cutaway View of Economizer Assembly**

**SERVICE**

**Servicing Coolers and Condensers** — When cooler heads and partition plates are removed, tube sheets are exposed showing the ends of tubes. The 30GX,HX units use a flooded cooler design. Water flows inside the tubes.

**TUBE PLUGGING** — A leaky tube can be plugged until retubing can be done. The number of tubes plugged determines how soon the cooler must be retubed. All tubes in the 30GX and 30HX coolers and 30HX condensers can be removed. Loss of unit capacity and efficiency as well as increased pump power will result from plugging tubes. Failed tubes should be replaced as soon as possible. Up to 10% of the total number of tubes can be plugged before retubing is necessary. Figure 14 shows an Elliot tube plug and a cross-sectional view of a plug in place. The same components for plugging and rolling tubes can be used for all coolers and 30HXC condensers. See Table 36.



**PIN AND RING INSTALLED**  
**Fig. 14 — Tube Plugging**

**Table 36 — Plugging Components**

COMPONENTS FOR PLUGGING	PART NUMBER
<b>For Tubes</b>	
Brass Pin	853103-1A*
Brass Ring	853002-640*
<b>For Holes without Tubes</b>	
Brass Pin	853103-1A*
Brass Ring	853002-738*
Roller Extension	S82-112/11
<b>Loctite</b>	No. 675†
<b>Locquic</b>	"N"†

\*Order directly from: Elliot Tube Company, Dayton, Ohio.  
†Can be obtained locally.

**Table 37 — Tube Diameters**

ITEM	INCHES	MILLIMETERS
<b>Tube sheet hole diameter:</b>	0.756	19.20
<b>Tube OD</b>	0.750	19.05
<b>Tube ID after rolling:</b>	0.704	17.88
<b>(includes expansion due to clearance)</b>	to 0.710	to 18.03

NOTE: Tubes replaced along heat exchanger head partitions must be flush with tube sheet.

**TIGHTENING COOLER/CONDENSER HEAD BOLTS**

**O-Ring Preparation** — When reassembling cooler and condenser heads, always check the condition of the O-ring(s) first. The O-ring should be replaced if there are any visible signs of deterioration, cuts or damage. Apply a thin film of grease to the O-ring before installation. This will aid in holding the O-ring into the groove while the head is installed. Torque all bolts to the following specification and in the sequence shown in Fig. 15.

- 3/4-in. Diameter Perimeter and Plate Bolts . . . . . 200 to 225 ft-lb. (271 to 305 N-m)

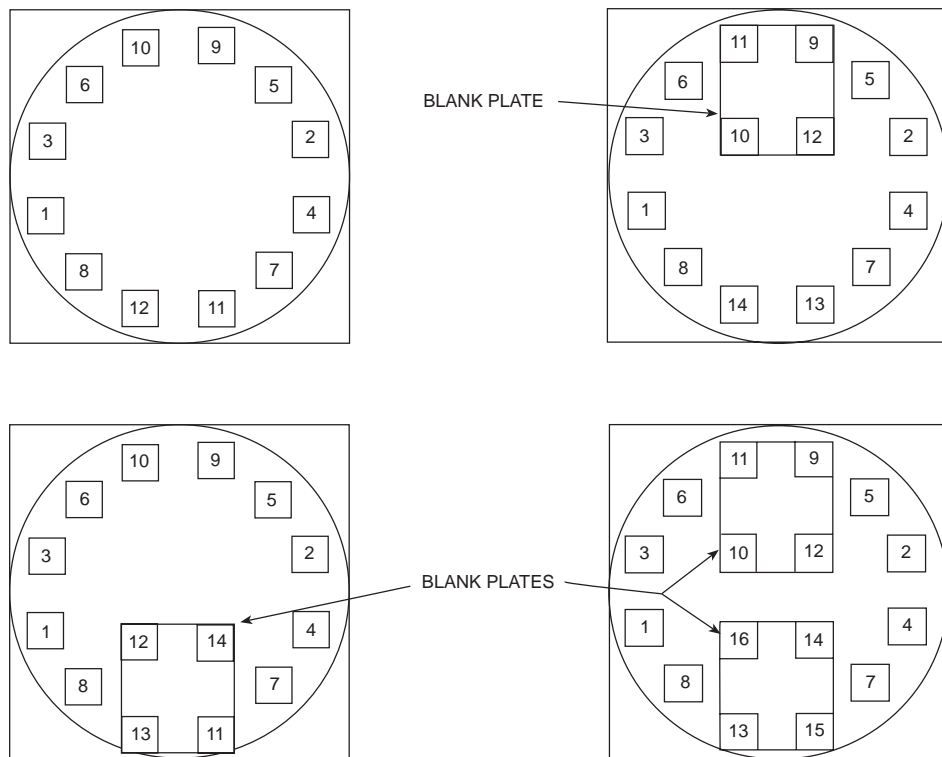
**CAUTION**

Use extreme care when installing plugs to prevent damage to the tube sheet section between the holes.

**RETUBING** (See Table 37) — When retubing is to be done, obtain service of qualified personnel experienced in boiler maintenance and repair. Most standard procedures can be followed when retubing the 30GX and 30HX heat exchangers. A 7% crush is recommended when rolling replacement tubes into the tubesheet. A 7% crush can be achieved by setting the torque on the gun at 48 to 50 in.-lb (5.4 to 5.6 N-m).

- The following Elliot Co. tube rolling tools are required:
- B3400 Expander Assembly
  - B3401 Cage
  - B3405 Mandrel
  - B3408 Rolls

Place one drop of Loctite No. 675 or equivalent on top of tube prior to rolling. This material is intended to "wick" into the area of the tube that is not rolled into the tube sheet, and prevent fluid from accumulating between the tube and the tube sheet. New tubes must also be rolled into the center tube sheet to prevent circuit-to-circuit refrigerant leakage.



**Fig. 15 — Cooler and Condenser Head Recommended Bolt Torque Sequence**

1. Install all bolts finger tight.
2. Follow numbered sequence shown for head type being installed. This will apply even pressure to the O-ring.
3. Apply torque in one-third steps until required torque is reached. Load all bolts to each one-third step before proceeding to the next one-third step.
4. No less than one hour later, retighten all bolts to required torque values.
5. Restore water/brine flow and check for leaks. Fix leaks as necessary. Replace insulation (on cooler heads only).

### Inspecting/Cleaning Heat Exchangers

**COOLERS** — Inspect and clean the cooler tubes at the end of the first operating season. Because these tubes have internal ridges, a rotary-type tube cleaning system is necessary to fully clean the tubes. Tube condition in the cooler will determine the scheduled frequency for cleaning, and will indicate whether water treatment is adequate in the chilled water/brine circuit. Inspect the entering and leaving thermistors for signs of corrosion or scale. Replace the sensor if corroded or remove any scale if found.

**CONDENSERS (30HX Only)** — Since this water circuit is usually an open-type system, the tubes may be subject to contamination and scale. Clean the condenser tubes with a rotary tube cleaning system at regular intervals, and more often if the water is contaminated. Inspect the entering and leaving condenser water thermistors (if installed) for signs of corrosion or scale. Replace the sensor if corroded or remove any scale if found.

Higher than normal condenser pressures, together with inability to reach full refrigeration load, usually indicate dirty tubes or air in the machine. If the refrigeration log indicates a rise above normal condenser pressures, check the condenser refrigerant temperature against the leaving condenser water temperature. If this reading is more than what the design difference is supposed to be, then the condenser tubes

may be dirty, or water flow may be incorrect. Due to the pressure in the R-134a system, air usually will not enter the machine; the refrigerant will leak out.

During the tube cleaning process, use brushes specially designed to avoid scraping and scratching the tube wall. Contact your Carrier representative to obtain these brushes. *Do not* use wire brushes.

#### **▲ CAUTION**

Hard scale may require chemical treatment for its prevention or removal. Consult a water treatment specialist for proper treatment procedures.

**Water Treatment** — Untreated or improperly treated water may result in corrosion, scaling, erosion, or algae. The services of a qualified water treatment specialist should be obtained to develop and monitor a treatment program.

#### **▲ CAUTION**

Water must be within design flow limits, clean and treated to ensure proper machine performance and reduce the potential of tubing damage due to corrosion, scaling, erosion, and algae. Carrier assumes no responsibility for chiller or condenser damage resulting from untreated or improperly treated water.

### Condenser Coils (30GX Only)

**COIL CLEANING** — Clean coils with a vacuum cleaner, fresh water, compressed air, or a bristle brush (not wire). Units installed in corrosive environments should have coil cleaning as part of a planned maintenance schedule. In this type of application, all accumulations of dirt should be cleaned off the coil.

### ⚠ CAUTION

Do not use high-pressure water or air to clean coils as fin damage may result.

**Condenser Fans (30GX Only)** — Each fan is supported by a formed wire mount bolted to a fan deck and covered with a wire guard. The exposed end of the fan motor shaft is protected from weather by grease. If the fan motor must be removed for service or replacement, be sure to regrease fan shaft and reinstall fan cover, retaining clips, and fan guard. For proper performance, the fans should be positioned as shown in Fig. 16 or 17. Tighten setscrews to  $14 \pm 1$  ft-lb ( $18 \pm 1.3$  N-m).

Check for proper rotation of the fan(s) once reinstalled (clockwise for high static and counterclockwise for standard viewed from above). If necessary to reverse, switch leads at contactor(s) in control box.

### Refrigerant Charging/Adding Charge

**IMPORTANT:** These units are designed for use with R-134a only. DO NOT USE ANY OTHER REFRIGERANT in these units without first consulting your Carrier representative.

### ⚠ CAUTION

When adding or removing charge, circulate water through the condenser (30HXC) and cooler at all times to prevent freezing. Freezing damage is considered abuse and may void the Carrier warranty.

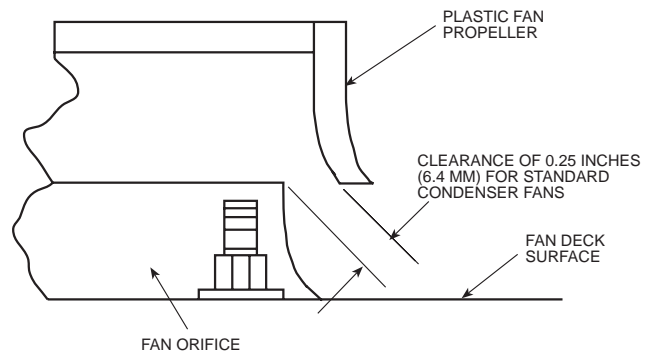
### ⚠ CAUTION

DO NOT OVERCHARGE system. Overcharging results in higher discharge pressure with higher cooling fluid consumption, possible compressor damage and higher power consumption.

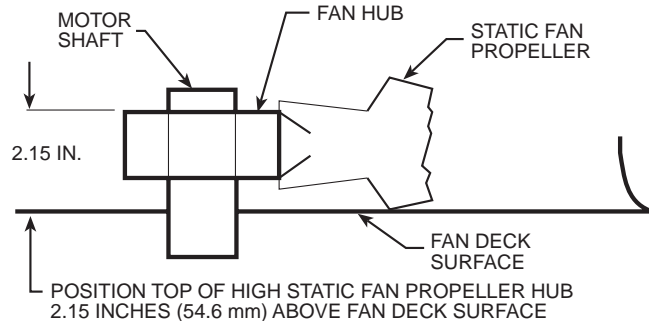
Indication of low charge on a 30HXC system:

**NOTE:** To check for low refrigerant charge on a 30HXC, several factors must be considered. A flashing liquid-line sight glass is not necessarily an indication of inadequate charge. There are many system conditions where a flashing sight glass occurs under normal operation. The 30HXC metering device is designed to work properly under these conditions.

1. Make sure that the circuit is running at a full-load condition. To check whether circuit A is fully loaded, enter **3** **STAT** on the HSIO keypad. The display will read "CIRCUIT A ANALOG VALUES." Using the down arrow key on the keypad, scroll down once to "Total Capacity." If this value is 100%, the circuit is at full load. To check circuit B, follow the same procedure, but enter **5** **STAT** on the keypad.
2. It may be necessary to use the Manual Control feature to force the circuit into a full-load condition. If this is the case, see the instructions for using the Manual Control feature in Table 19 of this manual.
3. With the circuit running at full load, verify that the cooler leaving fluid temperature is in the range of 38 to 46 F (3.3 to 7.8 C). Check pressure drop across liquid line strainer and replace strainer if necessary.
4. At this condition, observe the refrigerant in the liquid line sight glass. If there is a clear sight glass, and no signs of flashing, then the circuit is adequately charged. Skip the remaining steps.



**Fig. 16 — Condenser Fan Position (Standard Fan)**



**Fig. 17 — Condenser Fan Position (High Static Fan)**

5. If the refrigerant appears to be flashing, the circuit is probably low on charge. Verify this by checking the EXV Percent Open. This information can be accessed by entering **3** **STAT** on the HSIO keypad for Circuit A, or **5** **STAT** for Circuit B. Scroll down using the down arrow key on the keypad, until EXV Percent Open is displayed.
6. If the EXV Percent Open is greater than 60%, and the liquid-line sight glass is flashing, then the circuit is low on charge. Follow the procedure for adding charge for 30HXC units.

To add charge to the 30HXC systems:

1. Make sure that the unit is running at full load, and that the cooler leaving fluid temperature is in the range of 42 to 46 F (5.6 to 7.8 C).
2. At these operating conditions, check the liquid line sight glass. If there is a clear sight glass, then the unit has sufficient charge. If the sight glass is flashing, then check the EXV Percent Open. If this is greater than 60%, then begin adding charge.  
**NOTE:** A flashing liquid line sight glass at operating conditions other than those mentioned above is not necessarily an indication of low refrigerant charge.
3. Add 5 lb of liquid charge into the cooler using the 1/4-in. Schrader-type fitting located on the tube entering the bottom of the cooler. This fitting is located between the Electronic Expansion Valve (EXV) (size 076-146 units), or the economizer (size 161-271 units) and the cooler.
4. Observe the EXV Percent Open value. The EXV should begin closing as charge is being added. Allow the unit to stabilize. If the EXV Percent Open remains above 60%, and the sight glass continues flashing, add an additional 5 lb of liquid charge.
5. Allow the unit to stabilize, and again check the EXV Percent Open. Continue adding 5 lb at a time of liquid refrigerant charge, and allow the unit to stabilize before checking the EXV position.

- When the EXV Percent Open is in the range of 40 to 60%, check the liquid line sight glass. Slowly add enough additional liquid charge to ensure a clear sight glass. This should be done slowly to avoid over-charging the unit.
- Verify adequate charge by continuing to run at full load with 42 to 46 F (5.6 to 7.8 C) cooler leaving fluid temperature. Check that the refrigerant is not flashing in the liquid-line sight glass. The EXV Percent Open should be between 40 and 60%. The cooler level indicator should be in the range of 1.5 to 2.2.

Indication of low charge on a 30HXA, GX systems:

- Make sure that the circuit is running at a full load condition and all condenser fans are energized and running at full speed. To check whether circuit A is fully loaded, enter **3** **STAT** on the HSIO keypad. The display will read "CIRCUIT A ANALOG VALUES." Using the down arrow key on the keypad, scroll down once to "Total Capacity." If this value is 100%, the circuit is at full load. To check circuit B, follow the same procedure, but enter **5** **STAT** on the keypad.
- It may be necessary to use the Manual Control feature to force the circuit into a full-load condition. If this is the case, see the instructions for using the Manual Control feature in Table 19 on page 31 of this manual.
- With the circuit running at full-load, verify that the cooler leaving fluid temperature is in the range of 38 to 48 F (5.6 to 7.8 C).
- For 30HXA chillers, raise the compressor discharge to approximately 125 F (51.7 C) saturated discharge temperature (185 psig [1276 kPa]). For 30GX chillers, raise the compressor discharge to approximately 130 F (54.4 C) saturated discharge temperature (198 psig [1366 kPa]). Measure the liquid temperature entering the expansion device for 30HXA units. For 30GX units, measure the liquid temperature after the tee where all liquid lines have joined. The liquid temperature should be approximately 107 F (41.7 C) for optimum charge. If the temperature is greater than 107 F (41.7 C) and the sight glass is flashing, the circuit is undercharged.
- Add 5 lb of liquid charge into the cooler using the 1/4-in. Schrader-type fitting located on the tube entering the bottom of the cooler. This fitting is located between the Electronic Expansion Valve (EXV) (30HXA076-146 units, 30GX080-090 units), or the economizer (30HXA161-271 units, 30GX105-176 units) and the cooler.
- Allow the system to stabilize and then recheck the liquid temperature. Repeat Step 5 as needed allowing the system to stabilize between each charge addition. Slowly add charge as the sight glass begins to clear to avoid overcharging.

### Oil Charging/Low Oil Recharging

Addition of oil charge to 30HX,GX systems:

- If the 30HX,GX unit shuts off repeatedly on Low Oil Level (Alert number 71 or 72), this may be an indication of inadequate oil charge. It could also mean simply that oil is in the process of being reclaimed from the low-side of the system.
- Begin by running the unit at full load for 1½ hours. Use the Manual Control feature of the software if the unit does not normally run at full load.

- After running the unit for 1½ hours, allow the unit to restart and run normally. If the Low Oil Level alarms persist, continue following this procedure.
- Close the liquid line service valve, and place a pressure gage on top of the cooler. Enable the manual control feature using the HSIO keypad, and turn the LOR switch to local. Start the desired compressor by pressing **1** **ENTR** on the keypad, at the appropriate line on the display.
- Before starting the compressor, the unit will go through its normal pre-lube pump routine. If there is an insufficient level of oil in the oil separator, the compressor will not start, and a pre-start oil pressure alarm will be posted. Skip to Step 8.
- If the compressor starts successfully, observe the cooler pressure gage. When this gage reads approximately 10 psig, press **0** **ENTR** on the HSIO keypad, and move the LOR switch to the off position.
- Open the liquid line service valve and allow the unit to restart and run normally. If the Low Oil Level alarms persist, continue following this procedure.
- If none of the previous steps were successful, the unit is low on oil charge. Add oil to the oil separator using the 1/4-in. Schrader-type fitting on the discharge line entering the top of the oil separator (30HX units) or through the Schrader fitting on the top of the oil separator (30GX units).

### ⚠ CAUTION

Do not add oil at any other location as improper unit operation may result.

- Make sure that the unit is not running when adding oil, as this will make the oil charging process easier. Because the system is under pressure even when the unit is not running, it will be necessary to use a suitable pump (hand pump or electric pump) to add oil to the system.
- Using a suitable pump, add ½ gal. (1.89 L) of Castrol Icematic® SW-220 Polyolester oil (Carrier Specification number is PP47-32; absolutely no substitutes are approved) to the system. Make sure that the oil level safety switch is NOT jumpered, and allow the unit to restart and run normally. Do not exceed maximum oil charge. See Table 38.
- If low oil level problems persist, add another 1.89 L (½ gal.) of oil. Continue adding oil in 1.89 L (½ gal.) increments until the problem is resolved. If it is necessary to add more than 5.75 L (1.5 gallons) of oil to the system, contact your Carrier distributor service department.

Table 38 — Maximum Oil Charges

UNIT SIZE	CIRCUIT A (gal)	CIRCUIT A (L)	CIRCUIT B (gal)	CIRCUIT B (L)
30GX080-176	5.0	18.9	5.0	18.9
30GX205-265	7.0	26.5	5.0	18.9
30HXA076-186	5.0	18.9	5.0	18.9
30HXC076-186	4.5	17.0	4.5	17.0
30HXC206-271	7.5	28.4	5.0	18.9

**Oil Filter Maintenance** — Each compressor has its own internal oil filter and each circuit also has an in-line external filter. The internal oil filter pressure drop should be checked and filter changed (if necessary) after the initial 200-300 hours of compressor operation. It is recommended that oil line pressure loss checks be made on an annual basis thereafter to determine the need for filter changes. The need for filter maintenance can be monitored through system pressure drop. Discharge pressure is read at the oil separator and oil pressure is read at the compressor. This pressure differential is typically 15 to 20 psi (103 to 138 kPa) for a system with clean internal and external filters. See Pressure Transducers section, page 59 for information on removing discharge pressure transducers to measure discharge pressure. Figure 18 shows the location of the oil pressure bleed port on the compressor. A gage can be attached to this point so that two pressure drops can be measured. The difference between discharge pressure and the gage pressure will be the pressure loss due mainly to the external oil filter. If this value exceeds 10 psi (69 kPa), replace the external filter. The difference between the gage pressure and compressor oil pressure is the pressure drop through the internal oil filter. Replace the internal oil filter if the pressure drop is greater than 30 psi (207 kPa).

### REPLACING THE EXTERNAL OIL FILTER

#### ⚠ CAUTION

Compressor oil is pressurized. Use proper safety precautions when relieving pressure.

Fully front seat (close) the angle valve on the filter. Connect a charging hose to the oil pressure bleed port and drain the oil trapped between the filter and the internal check valve.

Use the **REST** function to cycle the oil solenoid a few times to properly seat the internal check valve as the pressure is being relieved. If the oil pressure does not bleed off using this method it will be necessary to remove the entire circuit charge. A pint of oil is typically what is removed during this process. Remove the charging hose.

Unscrew the nut from the other side of the filter and remove the old filter. Remove protective plastic caps from new filter and install. Draw a vacuum at the bleed port. Remove charging hose. Open angle valve enough to let oil flow. Check both fittings for leaks and repair if necessary. Backseat angle valve.

**REPLACING THE INTERNAL OIL FILTER** — Follow the procedure above to the point that the oil has been drained from the bleed port. Using a 3/4-in. allen wrench, remove the internal filter access cover (see Fig. 18). Remove the old filter. Replacement filters (one for each compressor) are factory supplied to cover the first changeout. After that, filters are field supplied. Remove the old O-ring from internal check valve. Lightly oil O-ring and install into groove. Install new filter open end first into the housing. Replace access cover and retorque to 150 ft-lb (203 N-m). Follow procedure in previous section for opening angle valve and purging lines. Check for leaks and repair if necessary.

### Compressor Changeout Sequence

**NOTE:** Replacement compressors can be ordered by calling 800-CARLYLE (800-227-5953). In most cases, replacement compressors can be shipped in 1 to 2 business days.

Compressor service requires metric tools and hardware. Change compressors according to the following procedure:

1. Turn off all main and control circuit power supplying the machine.

2. Close the discharge and liquid valve(s), suction valve, and cooler inlet line service valve (if equipped), oil line shutoff valve, economizer bubble tube valve (30HXA,C161-271 only) and minimum load shutoff valve (if equipped) for circuit to be changed. Disconnect the oil inlet line from the compressor. Disconnect oil filter with fitting at shutoff valve side and set filter and compressor inlet line assembly aside.
3. Remove any remaining refrigerant in the compressor and refrigerant lines using proper reclaiming techniques. All of the refrigerant that is in the cooler must be removed if there is no suction service valve installed on the cooler.

**IMPORTANT:** Cooler and condenser pumps must be energized. Fluid must be flowing through heat exchangers whenever adding or removing charge.

4. Remove junction box cover of compressor to be changed. Check main power leads for marked numbers. If no numbers are visible on leads, mark leads with appropriate numbers to match those printed on the ends of the terminal lugs. **This is extremely important as power leads MUST be installed on the exact terminals from which they were removed.**
5. Disconnect main power leads from compressor terminal lugs. Mark remaining control circuit wires (connected together with wire nuts) for ease of reconnecting later. The following color scheme applies (verify with label diagram on panel):

Loader 1	2 Violet wires
Loader 2	2 Pink wires
Motor Cooling Solenoid	1 Blue wire, 1 Brown wire *
Oil Solenoid	1 Orange wire, 1 Brown wire*
High-Pressure Switch	2 Red wires

\*One lead from the motor cooling and oil solenoids are connected together with a single brown wire.

6. Remove loader (mark solenoids no. 1 and 2 for replacement) and oil solenoids and high-pressure switch from compressor. Using 2 wrenches, carefully remove the oil pressure transducer from the compressor. These will all be reconnected to the replacement compressor.
- NOTE:** Some oil will leak out of the transducer fitting when the transducer is removed. See Fig. 18.
7. Mark motor temperature leads (2 blue wires) and remove from quick connect terminals in the junction box.

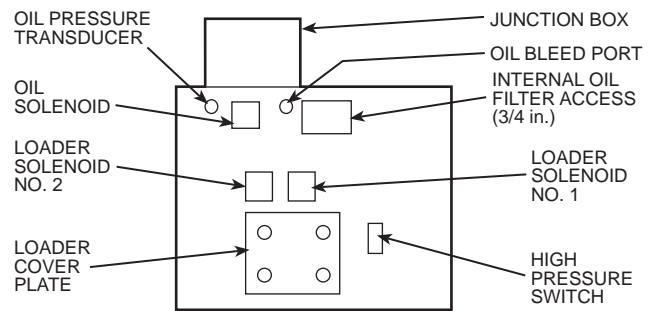
#### ⚠ CAUTION

The next steps involve compressor unbolting and removal. Compressor seals are made using O-rings. Use care when removing bolts and disconnecting flanges. The O-rings must NOT be re-used. New O-rings are provided with the replacement compressor. **The 06N screw compressors weigh approximately 900 pounds.** Be sure that an appropriate lifting cart or hoist is used to avoid injury. See Fig. 19 for lifting locations and center of gravity dimensions. Make sure compressor is properly rigged before unbolting.

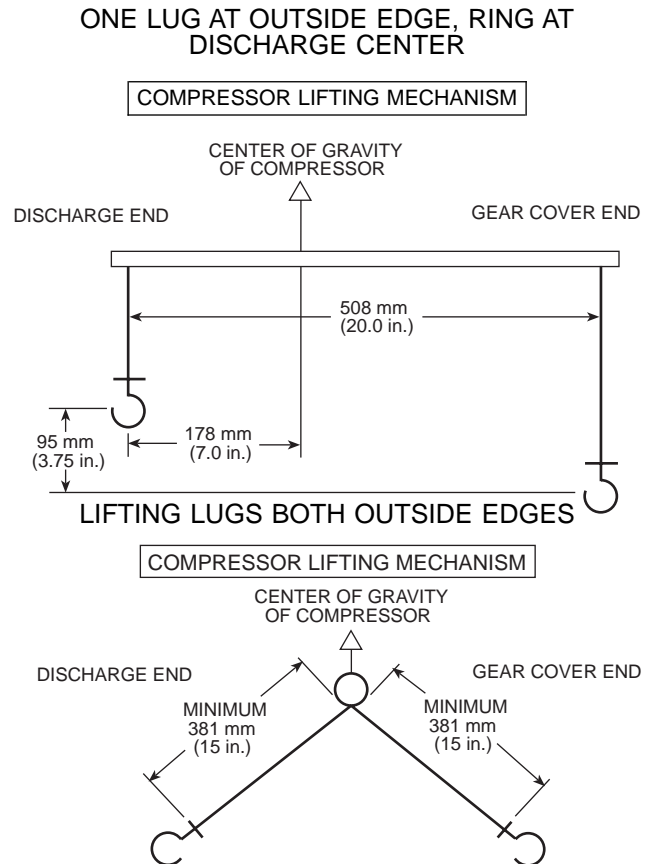
8. Remove the 2 bolts securing the motor cooling/economizer line flange to the compressor.



9. Remove the four M14 bolts securing the discharge line flange to the compressor. Two of the bolts also secure the mounting bracket for the external oil filter. Support the oil line to prevent damage to the line while the compressor is being changed. For 30GX units, place temporary protection over coils to prevent fin and tube damage.
10. Move lifting apparatus into place and attach to the 2 lifting rings on the compressor. Apply minimal tension to hold the compressor while the remaining bolts are removed.
11. Remove the 3/8-in. holddown bolt securing the foot at the discharge end of the compressor to the mounting bracket on the cooler. A foot bracket will be mounted to the replacement compressor.
12. Remove the 4 lockwashers and nuts securing the compressor to the suction flange of the cooler. The compressor is held in place using four M14 x 2 studs through the suction nozzle of the cooler. The studs have an E-12 external Torx drive head. If possible, remove studs; if studs hit the cooler insulation, leave them in place — they will not interfere with compressor removal or installation. Save all the hardware as it will be needed to install the replacement compressor.
13. After checking to ensure all lines, wires, conduits, etc. are free and out of the way, remove compressor from cooler. Apply a light film of O-ring grease to new O-ring and place back into groove in mounting flange of compressor. If the new compressor is the A1 or A2 (30HX units) compressor, remove the compressor junction box and rotate it 180 degrees. Tighten screws to 6.8 to 9.5 N-m (5 to 7 ft-lb). The A1 and A2 compressors are on the right side of the unit when facing the unit control box.
14. Remove suction cover plate and bolts from new compressor and set compressor on unit flange. Thread the studs all the way back into the compressor. Install the 4 lockwashers and nuts finger-tight. Tighten bolts in a crossing pattern to a range of 81.4 to 135.6 N-m (60 to 100 ft-lb). Do NOT overtighten as damage may result to O-ring. Install and tighten hold down bolt in mounting foot.
15. Remove motor cooling/economizer and discharge line cover plates from new compressor.
16. Apply a light film of O-ring grease to motor cooling/economizer and discharge line O-rings, place back into grooves and install flange bolts. Tighten discharge line bolts in a crossing pattern to a range of 81.4 to 135.6 N-m (60 to 100 ft-lb). Tighten motor cooling/economizer bolts to a range of 81.4 to 108.5 N-m (60 to 80 ft-lb). Do NOT overtighten as damage may result to O-rings.
17. Reconnect the oil filter to the shutoff valve and oil line to the compressor. Install oil line straight into fitting until ferrule seats against fitting. Thread packing nut onto fitting and tighten finger tight. Use a backup wrench to finish tightening the nut. Do not overtighten.
18. Reinstall the loader and oil solenoids, high-pressure switch, and oil pressure transducer. Make sure the loader solenoids are installed on the correct number loader.
19. Reconnect conduits back into compressor junction box. Reconnect all wiring that was removed in Steps 4, 5, and 7. The replacement compressor comes with a reverse rotation switch. This switch must be wired in series with the high-pressure switch for compressor protection. Reconnect these wires as shown in Fig. 20.

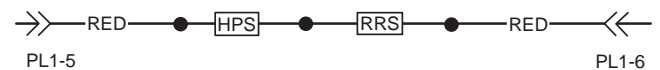


**Fig. 18 — Transducer Removal**



NOTE: Locate strap from center of gravity lifting ring and support motor casing to provide 3-point level rigging.

**Fig. 19 — Compressor Lifting Diagrams**



**LEGEND**  
**HPS** — High-Pressure Switch  
**PL** — Plug  
**RRS** — Reverse Rotation Switch

**Fig. 20 — High-Pressure Switch Wiring**

20. Leak check compressor and refrigerant lines with nitrogen. Repair any leaks found. Remove nitrogen from system. Evacuate compressor and refrigerant lines. Refer to the Refrigerant and Oil Charging sections on pages 54 and 55 for recharging procedures.
21. Open all shutoff valves and leak check the circuit and all fittings and joints. Repair any leaks found.

22. Restore main and control power to the machine. Using the HSIO, enter the quick test function by pressing **1** **TEST** (for compressor A1 or A2 replacement) or **2** **TEST** (for compressor B1 replacement). Test the operation of the solenoids. Press **1** **ENTR** to test each loader solenoid, then use the **↓** key to find the motor cooling and oil solenoids and test them in the same manner. Pressing the **↓** key after each output turns the solenoid off (or press **0** **ENTR**). It is important that the loaders are located properly (loader 1 on right hand side when viewed from side opposite control box on 30HX units, on left hand side when reaching over compressor to far side on 30GX units).
23. Start the compressor using the Manual mode. Press **8** **SRVC** at the HSIO. Press **1** **ENTR** to enable the Manual mode. When display changes to "Enable," switch the Local-Off-Remote switch to the Local position. Select the desired compressor using the down arrow key. Press **1** **ENTR** to start the compressor. Use the down arrow key and press **1** **ENTR** to energize both loaders. Let the circuit stabilize with both loaders energized. Refer to the Refrigerant and Oil Charging sections of this document for recharging procedures and performance criteria.

**BURNOUT CLEANUP PROCEDURE** — If a screw compressor motor burns out on a 30GX,HX chiller, a simple cleanup should be performed. The following procedure provides the minimum steps to be taken before restarting the circuit.

1. Remove the oil from the oil separator. This can be facilitated by connecting a hose to the port located on the service valve entering the external oil filter. Run the hose to a container(s) that can hold up to 5 to 6 gallons of oil. To force out most of the oil in the separator pressurize the circuit. To remove the remaining oil, the pre-lube pump can be run in **TEST** mode from the HSIO. To prevent wear to the gears, do not allow the pre-lube pump to operate "dry."
2. Remove the failed compressor following the Compressor Changeout Sequence procedure above.
3. Once the compressor is removed access the oil catch pan through the cooler-compressor mounting flange. Clean out any debris which may have collected in the oil catch pan.
4. Install a new compressor.
5. To dilute and remove any residual oil left in the separator, pump approximately ½ gallon of compressor oil into the oil separator using the Schrader port located on top of the separator (30GX) or on the discharge line (30HX) and remove using the pre-lube pump described in Step 1.
6. Disconnect the hose from the external oil filter service valve.
7. Install a new filter drier and compressor external oil filter.
8. Measure in the amount of Castrol SW 220 Polyolester oil as specified on the nameplate of the chiller.
9. Leak check, evacuate and recharge the machine as described in this manual with the amount of R-134a stated on the chiller nameplate.
10. Perform periodic acid checks on the circuit and change the filter drier in the motor cooling line as necessary.

Use the Carrier Standard Service Techniques Manual as a source of reference.

**Moisture-Liquid Indicator** — Clear flow of liquid refrigerant indicates sufficient charge in the system. Note, however, that bubbles in the sight glass do not necessarily indicate insufficient charge. Moisture in the system is measured in parts per million (ppm), changes of color of indicator are:

- Green* — moisture is below 80 ppm;
- Yellow-green (chartreuse)* — 80 to 225 ppm (caution);
- Yellow (wet)* — above 225 ppm.

Change filter drier at the first sign of moisture in the system.

**IMPORTANT:** Unit must in operation for at least 12 hours before moisture indicator can give an accurate reading. With the unit running, the indicating element must be in contact with liquid refrigerant to give true reading.

**Filter Drier** — Whenever moisture-liquid indicator shows presence of moisture, replace filter drier. Refer to Carrier Standards Service Technique Manual, Chapter 1, Refrigerants, for details on servicing filter driers.

**Liquid Line Service Valve** — This valve is located ahead of the filter drier and provides a ¼-in. Schrader connection (30GX only) for field charging. In combination with compressor discharge service valve, each circuit can be pumped down into the high side for servicing.

**Thermistors** — To aid in verifying thermistor performance, resistances at various temperatures are listed for all thermistors (except motor thermistors) in Tables 39A and 39B. See Table 40 for motor thermistor values.

**LOCATION** — General location of thermistor sensors and terminal connections in the control box are listed in Table 2.

#### THERMISTOR REPLACEMENT

**▲ CAUTION**

Liquid level thermistors are installed in the top of the cooler using compression fittings. All other thermistors are installed in wells and will slide out of the wells easily. The wells are under refrigerant pressure (cooler EWT and LWT are under waterside pressure) and do not need to be removed to replace a faulty thermistor.

To replace thermistors T1, T2, T5, or T6 (Entering, Leaving Water; Discharge Gas Temperature):

Disconnect appropriate wires from PSIO-2 in unit control box. Remove thermistor cable from harness. Remove and discard original thermistor from well. Insert new thermistor in well body to its full depth. Add a small amount of thermal conductive grease to thermistor probe and well. Thermistors are friction-fit thermistors and will slip back into well located at the cooler head (T1, T2) or at the top of the condenser shell (T5, T6). Secure thermistor to well body with a wire tie to prevent thermistor from working its way out of the well. See Fig. 21.

To replace thermistors T3 or T4 (Liquid Level Sensors):

See the Inspecting/Opening Economizers section on page 51 for information on transferring the refrigerant charge

to the high side. Transfer refrigerant and reclaim any refrigerant remaining in the low side.

NOTE: A new packing nut and ferrule will be required as the old one is not removable from the old thermistor.

For 30GX080-176 and all 30HX units cut wire nuts apart to appropriate blue leads at PSIO-1 (J7-5,6 for T3; J7-8,9 for T4) and red leads connecting wires to TRAN-7. Remove old leads from control box harness. For 30GX205-265 units, disconnect plug assembly at liquid level sensor. Loosen the packing nut fully from the well threads. Remove and discard old thermistor and packing nut. Slide new packing nut then ferrule up onto new thermistor probe from inserted end. Insertion depth is dependent on unit model number. See Fig. 22 and Table 41.

Hand tighten packing nut to position ferrule while holding thermistor in position. With wrench, tighten enough to firmly secure thermistor in place in well. Run new harness wires into main control box for 30GX080-176 and all 30HX units. Reconnect blue wires at PSIO-1 for thermistor reading and red wires to TRAN-7. Reconnect plug assembly to new liquid level sensor for 30GX205-265 units. Restore unit control power only and verify that level thermistor is reading correctly. Check system low side for leaks and repair as necessary. Evacuate low side and open circuit discharge and liquid valves.

To service compressor motor thermistors:

Two thermistors are factory installed in each compressor. Connections for the thermistors are located in the compressor junction box. There are 3 terminals for the thermistors: S1, S2, and C. Motor temperature is measured by leads connected to one of the S terminals and the C terminal. If a compressor motor thermistor failure occurs, verify that there is a true short or open circuit at these terminals. If one of the thermistors fails, disconnect and relocate the wire on one of the S terminals to the other S terminal (S1 to S2 or S2 to S1). The thermistors are not serviceable in the field. If both of the compressor motor thermistors fail, compressor replacement is required. See Table 40 for motor thermistor temperature and resistance values.

**Pressure Transducers** — A single style of pressure transducer is used for both high- and low-pressure sensing on the 30GX,HX chillers. The transducers operate on a 5 vdc supply. The power supply for this is a 24 vac to 5 vdc full wave rectified power supply, PS1. See unit component arrangement label for mounting location and terminal connections in the control box. Refer to Fig. 23A and 23B for pressure transducer locations.

**PRESSURE TRANSDUCER CALIBRATION** — Pressure transducers are factory installed on all models to read Discharge, Suction, Economizer (reads leaving condenser pressure on models without economizer), and Oil pressure. DO NOT attempt to calibrate any of these transducers by the pressure gage method unless the transducer is connected to a fully charged refrigerant system. A more accurate method of calibration is used by the 30GX,HX software and corrects for

ambient temperature when calibrating. Calibrating a transducer when the system is under nitrogen charge will result in an incorrect offset being applied to the reading (due to temperature correction). Although these transducers are calibrated at the factory, replacement transducers require calibration for accurate readings. Calibration is also required when replacing a PSIO. Access to the transducer calibration area is through the Service function and the transducers can be calibrated at the current system pressure using a pressure gage at the same point or exposed to atmospheric pressure. In the example in Table 42, the Circuit A Discharge Pressure transducer has been replaced and needs to be calibrated. A pressure gage has been installed at the transducer and reads 85 psi (must be in the range of -5.0 to 185.0 psi). See Table 42.

### ▲ CAUTION

Use care when removing the oil pressure transducers from the compressor fitting. The fitting that the transducers mount in is sealed with an O-ring Schrader fitting into the compressor casting. Do NOT overtighten the transducer when replacing after calibration. Hold both fittings with wrenches when removing and reinstalling.

The control will apply the 0.8 psi offset from the calibration example in Table 42 to all future readings. The calibration process for any of the other pressure transducers is done in a similar manner. A transducer can also be calibrated at atmospheric pressure by removing the transducer from the system. To do this, carefully unplug the transducer connector. Unscrew the transducer from its mounting location and reconnect the connector. Follow the steps in Table 42 to read the current pressure and enter 0.0 psig as the gage pressure. Remove the connector from the transducer, thread the transducer back onto the fitting from which it was removed (do NOT use thread sealant/compound), and reinstall the connector.

If it is necessary, all of the transducers may be calibrated at 0.0 psig. All of the transducers must be removed from the system and reconnected in atmosphere as described. When complete, scroll down under   to "Calibrate All at 0 PSIG" and press  . A "Yes" will be displayed at this step and will automatically change back to "No" once all transducers have been successfully calibrated. Reconnect the transducers and connectors as described above. All transducers are mounted on Schrader fittings. Therefore, it is NOT necessary to remove system refrigerant charge. Use a catch pan when removing the oil pressure transducer for calibration as oil will leak out through the Schrader fitting.

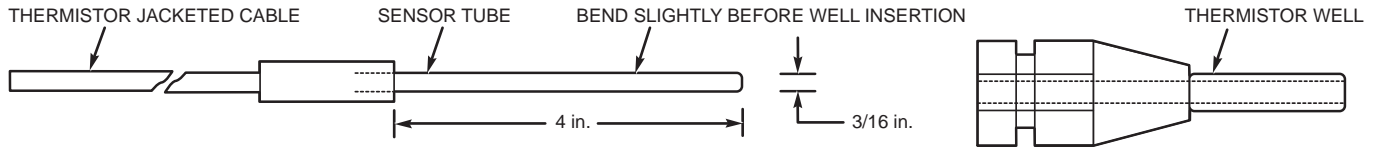
**TROUBLESHOOTING** — If transducer is suspected of being faulty, first check supply voltage to transducer. Supply voltage should be 5 vdc ± .2 v. If supply voltage is correct, compare pressure reading displayed on keypad and display module against pressure shown on a calibrated pressure gage. If the 2 pressure readings are not reasonably close, replace pressure transducer.

**Table 39A — Thermistor Temperatures (°F) vs Resistance/Voltage Drop  
(NOTE: These values do NOT Apply to the Motor Temperature Thermistors )**

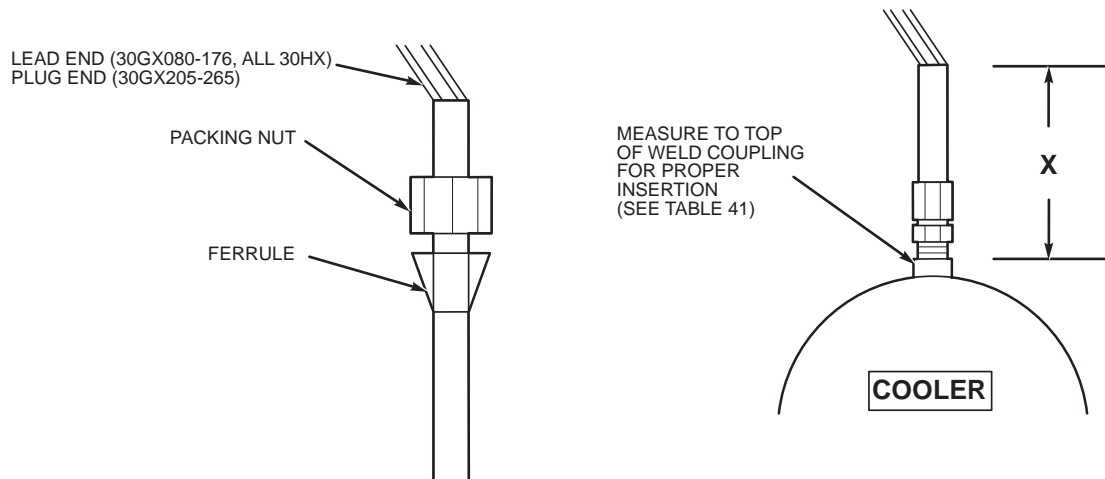
TEMP (F)	VOLTAGE DROP (V)	RESISTANCE (Ohms)	TEMP (F)	VOLTAGE DROP (V)	RESISTANCE (Ohms)	TEMP (F)	VOLTAGE DROP (V)	RESISTANCE (Ohms)
-25	4.821	98,010	59	3.437	7,868	143	1.250	1,190
-24	4.818	94,707	60	3.409	7,665	144	1.230	1,165
-23	4.814	91,522	61	3.382	7,468	145	1.211	1,141
-22	4.806	88,449	62	3.353	7,277	146	1.192	1,118
-21	4.800	85,486	63	3.323	7,091	147	1.173	1,095
-20	4.793	82,627	64	3.295	6,911	148	1.155	1,072
-19	4.786	79,871	65	3.267	6,735	149	1.136	1,050
-18	4.779	77,212	66	3.238	6,564	150	1.118	1,029
-17	4.772	74,648	67	3.210	6,399	151	1.100	1,007
-16	4.764	72,175	68	3.181	6,238	152	1.082	986
-15	4.757	69,790	69	3.152	6,081	153	1.064	965
-14	4.749	67,490	70	3.123	5,929	154	1.047	945
-13	4.740	65,272	71	3.093	5,781	155	1.029	925
-12	4.734	63,133	72	3.064	5,637	156	1.012	906
-11	4.724	61,070	73	3.034	5,497	157	0.995	887
-10	4.715	59,081	74	3.005	5,361	158	0.978	868
-9	4.705	57,162	75	2.977	5,229	159	0.962	850
-8	4.696	55,311	76	2.947	5,101	160	0.945	832
-7	4.688	53,526	77	2.917	4,976	161	0.929	815
-6	4.676	51,804	78	2.884	4,855	162	0.914	798
-5	4.666	50,143	79	2.857	4,737	163	0.898	782
-4	4.657	48,541	80	2.827	4,622	164	0.883	765
-3	4.648	46,996	81	2.797	4,511	165	0.868	750
-2	4.636	45,505	82	2.766	4,403	166	0.853	734
-1	4.624	44,066	83	2.738	4,298	167	0.838	719
0	4.613	42,679	84	2.708	4,196	168	0.824	705
1	4.602	41,339	85	2.679	4,096	169	0.810	690
2	4.592	40,047	86	2.650	4,000	170	0.797	677
3	4.579	38,800	87	2.622	3,906	171	0.783	663
4	4.567	37,596	88	2.593	3,814	172	0.770	650
5	4.554	36,435	89	2.563	3,726	173	0.758	638
6	4.540	35,313	90	2.533	3,640	174	0.745	626
7	4.527	34,231	91	2.505	3,556	175	0.734	614
8	4.514	33,185	92	2.476	3,474	176	0.722	602
9	4.501	32,176	93	2.447	3,395	177	0.710	591
10	4.487	31,202	94	2.417	3,318	178	0.700	581
11	4.472	30,260	95	2.388	3,243	179	0.689	570
12	4.457	29,351	96	2.360	3,170	180	0.678	561
13	4.442	28,473	97	2.332	3,099	181	0.668	551
14	4.427	27,624	98	2.305	3,031	182	0.659	542
15	4.413	26,804	99	2.277	2,964	183	0.649	533
16	4.397	26,011	100	2.251	2,898	184	0.640	524
17	4.381	25,245	101	2.217	2,835	185	0.632	516
18	4.366	24,505	102	2.189	2,773	186	0.623	508
19	4.348	23,789	103	2.162	2,713	187	0.615	501
20	4.330	23,096	104	2.136	2,655	188	0.607	494
21	4.313	22,427	105	2.107	2,597	189	0.600	487
22	4.295	21,779	106	2.080	2,542	190	0.592	480
23	4.278	21,153	107	2.053	2,488	191	0.585	473
24	4.258	20,547	108	2.028	2,436	192	0.579	467
25	4.241	19,960	109	2.001	2,385	193	0.572	461
26	4.223	19,393	110	1.973	2,335	194	0.566	456
27	4.202	18,843	111	1.946	2,286	195	0.560	450
28	4.184	18,311	112	1.919	2,239	196	0.554	445
29	4.165	17,796	113	1.897	2,192	197	0.548	439
30	4.145	17,297	114	1.870	2,147	198	0.542	434
31	4.125	16,814	115	1.846	2,103	199	0.537	429
32	4.103	16,346	116	1.822	2,060	200	0.531	424
33	4.082	15,892	117	1.792	2,018	201	0.526	419
34	4.059	15,453	118	1.771	1,977	202	0.520	415
35	4.037	15,027	119	1.748	1,937	203	0.515	410
36	4.017	14,614	120	1.724	1,898	204	0.510	405
37	3.994	14,214	121	1.702	1,860	205	0.505	401
38	3.968	13,826	122	1.676	1,822	206	0.499	396
39	3.948	13,449	123	1.653	1,786	207	0.494	391
40	3.927	13,084	124	1.630	1,750	208	0.488	386
41	3.902	12,730	125	1.607	1,715	209	0.483	382
42	3.878	12,387	126	1.585	1,680	210	0.477	377
43	3.854	12,053	127	1.562	1,647	211	0.471	372
44	3.828	11,730	128	1.538	1,614	212	0.465	367
45	3.805	11,416	129	1.517	1,582	213	0.459	361
46	3.781	11,112	130	1.496	1,550	214	0.453	356
47	3.757	10,816	131	1.474	1,519	215	0.446	350
48	3.729	10,529	132	1.453	1,489	216	0.439	344
49	3.705	10,250	133	1.431	1,459	217	0.432	338
50	3.679	9,979	134	1.408	1,430	218	0.425	332
51	3.653	9,717	135	1.389	1,401	219	0.417	325
52	3.627	9,461	136	1.369	1,373	220	0.409	318
53	3.600	9,213	137	1.348	1,345	221	0.401	311
54	3.575	8,973	138	1.327	1,318	222	0.393	304
55	3.547	8,739	139	1.308	1,291	223	0.384	297
56	3.520	8,511	140	1.291	1,265	224	0.375	289
57	3.493	8,291	141	1.289	1,240	225	0.366	282
58	3.464	8,076	142	1.269	1,214			

**Table 39B — Thermistor Temperatures (°C) vs Resistance/Voltage Drop**  
 (NOTE: These Values do NOT Apply to the Motor Temperature Thermistors)

TEMP (C)	VOLTAGE DROP (V)	RESISTANCE (Ohms)	TEMP (C)	VOLTAGE DROP (V)	RESISTANCE (Ohms)	TEMP (C)	VOLTAGE DROP (V)	RESISTANCE (Ohms)
-40	4.896	168 230	10	3.680	9 949	60	1.291	1 244
-39	4.889	157 440	11	3.633	9 485	61	1.258	1 200
-38	4.882	147 410	12	3.585	9 044	62	1.225	1 158
-37	4.874	138 090	13	3.537	8 627	63	1.192	1 118
-36	4.866	129 410	14	3.487	8 231	64	1.160	1 079
-35	4.857	121 330	15	3.438	7 855	65	1.129	1 041
-34	4.848	113 810	16	3.387	7 499	66	1.099	1 006
-33	4.838	106 880	17	3.337	7 161	67	1.069	971
-32	4.828	100 260	18	3.285	6 840	68	1.040	938
-31	4.817	94 165	19	3.234	6 536	69	1.012	906
-30	4.806	88 480	20	3.181	6 246	70	0.984	876
-29	4.794	83 170	21	3.129	5 971	71	0.949	836
-28	4.782	78 125	22	3.076	5 710	72	0.920	805
-27	4.769	73 580	23	3.023	5 461	73	0.892	775
-26	4.755	69 250	24	2.970	5 225	74	0.865	747
-25	4.740	65 205	25	2.917	5 000	75	0.838	719
-24	4.725	61 420	26	2.864	4 786	76	0.813	693
-23	4.710	57 875	27	2.810	4 583	77	0.789	669
-22	4.693	54 555	28	2.757	4 389	78	0.765	645
-21	4.676	51 450	29	2.704	4 204	79	0.743	623
-20	4.657	48 536	30	2.651	4 028	80	0.722	602
-19	4.639	45 807	31	2.598	3 861	81	0.702	583
-18	4.619	43 247	32	2.545	3 701	82	0.683	564
-17	4.598	40 845	33	2.493	3 549	83	0.665	547
-16	4.577	38 592	34	2.441	3 404	84	0.648	531
-15	4.554	38 476	35	2.389	3 266	85	0.632	516
-14	4.531	34 489	36	2.337	3 134	86	0.617	502
-13	4.507	32 621	37	2.286	3 008	87	0.603	489
-12	4.482	30 866	38	2.236	2 888	88	0.590	477
-11	4.456	29 216	39	2.186	2 773	89	0.577	466
-10	4.428	27 633	40	2.137	2 663	90	0.566	456
-9	4.400	26 202	41	2.087	2 559	91	0.555	446
-8	4.371	24 827	42	2.039	2 459	92	0.545	436
-7	4.341	23 532	43	1.991	2 363	93	0.535	427
-6	4.310	22 313	44	1.944	2 272	94	0.525	419
-5	4.278	21 163	45	1.898	2 184	95	0.515	410
-4	4.245	20 079	46	1.852	2 101	96	0.506	402
-3	4.211	19 058	47	1.807	2 021	97	0.496	393
-2	4.176	18 094	48	1.763	1 944	98	0.486	385
-1	4.140	17 184	49	1.719	1 871	99	0.476	376
0	4.103	16 325	50	1.677	1 801	100	0.466	367
1	4.065	15 515	51	1.635	1 734	101	0.454	357
2	4.026	14 749	52	1.594	1 670	102	0.442	346
3	3.986	14 026	53	1.553	1 609	103	0.429	335
4	3.945	13 342	54	1.513	1 550	104	0.416	324
5	3.903	12 696	55	1.474	1 493	105	0.401	312
6	3.860	12 085	56	1.436	1 439	106	0.386	299
7	3.816	11 506	57	1.399	1 387	107	0.370	285
8	3.771	10 959	58	1.363	1 337			
9	3.726	10 441	59	1.327	1 290			



**Fig. 21 — Thermistor Replacement (T1, T2, T5, or T6)**



**Fig. 22 — Thermistor (Liquid Level Sensor) Replacement**

**Table 40 — Thermistor Temperatures vs Resistance, Motor Temperature Thermistors**

TEMP (F)	TEMP (C)	RESISTANCE (Ohms)
-22	-30	88,480.0
-13	-25	65,205.0
-4	-20	48,536.0
5	-15	36,476.0
14	-10	27,663.0
23	-5	21,163.0
32	0	16,325.0
41	5	12,696.0
50	10	9,949.5
59	15	7,855.5
68	20	6,246.0
77	25	5,000.0
86	30	4,028.4
95	35	3,265.7
104	40	2,663.2
113	45	2,184.2
122	50	1,801.2
131	55	1,493.1
140	60	1,243.9
149	65	1,041.4
158	70	875.8
167	75	739.7
176	80	627.6
185	85	534.9
194	90	457.7
203	95	393.3
212	100	339.3
221	105	293.8
230	110	255.3
239	115	222.6
248	120	194.8

NOTE: Motor temperature thermistor values must be verified using resistance. Voltage drop cannot be used.

**Table 41 — Thermistor Depth**

UNIT MODEL NUMBER	THERMISTOR DEPTH "X"-in. (mm)
30GX080-090	6.00 (152.4)
30GX105-115	4.25 (108.0)
30GX125-136	5.56 (141.2)
30GX150,151	6.00 (152.4)
30GX160,161	4.25 (108.0)
30GX175,176	4.25 (108.0)
30GX205-226	3.94 (100.0)
30GX250-265	4.82 (122.4)
30HXA,C076-086	5.13 (130.3)
30HXA,C096	6.00 (152.4)
30HXA,C106	4.25 (108.0)
30HXA,C116-126	5.13 (130.3)
30HXA,C136-146	6.00 (152.4)
30HXA,C161-171	4.25 (108.0)
30HXA,C186	5.56 (141.2)
30HXA,C206	3.94 (100.0)
30HXA,C246-271	4.82 (122.4)

**Table 42 — Calibrating Pressure Transducers (Pressure Gage Installed)**

KEYPAD ENTRY	DISPLAY RESPONSE	COMMENTS
	CALIBRATION OFFSET	
	CIRCUIT A PRESSURE	
	Discharge Pressure 84.2 PSI	Current reading is displayed.
	Discharge Pressure 85.0 PSI	Enter gage pressure reading to nearest tenth. Control will allow offset of up to 6 psig. Transducer calibration is now complete.

**Safety Devices** — The 30GX/HX chillers contain many safety devices and protection logic built into the electronic control. Following is a description of the major safeties.

**COMPRESSOR PROTECTION**

**Motor Overload** — One factory preset solid-state overload protects each compressor against overcurrent. Do not bypass the overload or make any changes to the overload setting. Determine the cause for trouble and correct the problem before resetting a tripped overload. In addition to the overload, each compressor is further protected by the Compressor Protection Module. Each module has a factory installed and configured 8-pin header. The configuration of this header defines the must-trip amps at which the CPM will turn the compressor off. See Appendix D for correct setting of overload and configuration headers.

Each CPM board also reads the status of each compressor's high-pressure switch. All compressors have factory-installed high-pressure switches. For 30GX units, the switch is set to trip at 303 ± 7 psig (2089 ± 48 kPa). The setting for 30HXA units is 275 ± 7 psig (1896 ± 48 kPa) and for 30HXC units the setting is 191 ± 7 psig (1317 ± 48 kPa). If the switch opens during operation, the compressor will be shut down. The CPM will reset automatically when the switch closes, however, a manual reset is required to restart the compressor.

**OIL SEPARATOR HEATERS (30GX)** — Each oil separator circuit has a heater mounted on the underside of the vessel. The heater is energized with control circuit power. After a prolonged shutdown or service job, additional time may be required before starting the unit. Oil heaters are energized when the discharge gas temperature falls below 105 F (40.6 C). The heaters are deenergized when the discharge gas temperature rises above 110 F (43.3 C). The control will allow the chiller to attempt to start with the heaters energized and will keep the heaters on, even when running, until the discharge gas temperature reaches 110 F (43.3 C). Note that the oil heaters are deenergized if the oil level switch is open.

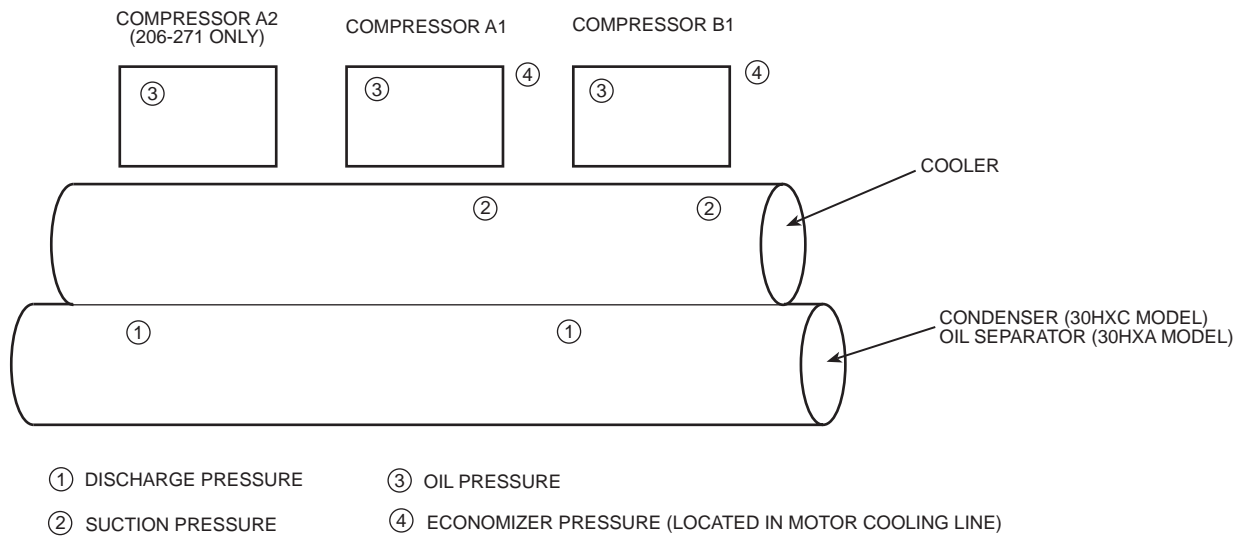
**COOLER PROTECTION**

**Low Water Temperature** — Microprocessor is programmed to shut the chiller down if the leaving fluid temperature drops below 34 F (1.1 C) for water or more than 8° F (4.4° C) below set point for brine units. When the fluid temperature rises 6° F (3.3° C) above the leaving fluid set point, the safety resets and the chiller restarts. Reset is automatic as long as this is the first occurrence of the day.

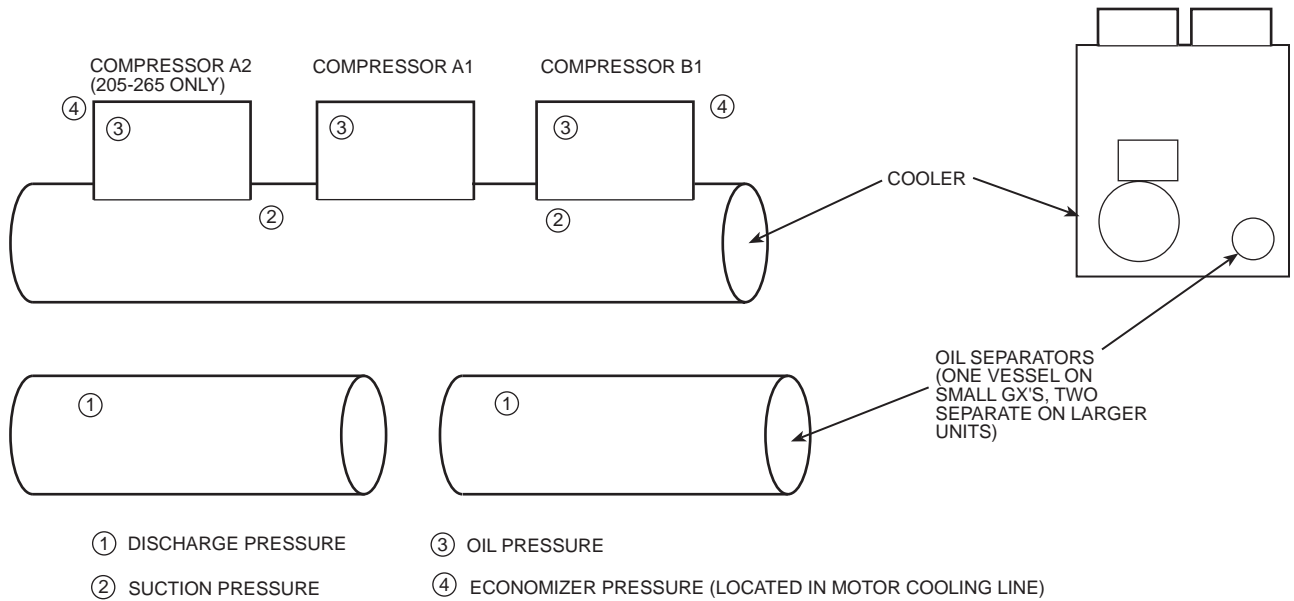
**IMPORTANT:** If the unit is installed in an area where ambient temperatures fall below 32 F (0° C), inhibited ethylene glycol or other suitable solution must be used in the chilled fluid circuit.

**Relief Devices** — Fusible plugs are located in each circuit (30GX only) between the condenser and the liquid line shutoff valve.

**PRESSURE RELIEF VALVES** — Valves are installed in each circuit and are located on all coolers. One relief valve is also installed on each 30HXC condenser. Both circuits' oil separators on 30GX and 30HXA units have factory-installed relief valves as well. These valves are designed to relieve if an abnormal pressure condition arises. Relief valves on all coolers and 30HXC condensers relieve at 220 psi (1517 kPa). Relief valves on 30GX and 30HXA oil separators relieve at 320 psi (2206 kPa). Units with factory-installed suction service valves also have a relief valve in each compressor discharge line. These valves are designed to relieve at 350 psig (2413 kPa). *These valves should not be capped.* If a valve relieves, it should be replaced. If the valve is not replaced, it may relieve at a lower pressure, or leak due to trapped dirt from the system which may prevent resealing.



**Fig. 23A — 30HX Pressure Transducer Locations**



**Fig. 23B — 30GX Pressure Transducer Locations**

Pressure relief valves located on cooler and condenser shells and 30HXA oil separator shells have 3/4-in. NPT connections for relief. The 30GX oil separators have 1/2-in. male flare connections. Some local building codes require that relieved gases be removed. This connection allows conformance to this requirement.

## Control Modules

### ▲ CAUTION

Turn controller power off before servicing controls. This ensures safety and prevents damage to controller.

PROCESSOR MODULE (PSIO-1), HIGH-VOLTAGE RELAY MODULE (DSIO-HV), AND EXV DRIVER MODULE (DSIO-EXV), 12/6 MODULE (PSIO-2) — The PSIO and DSIO modules all perform continuous diagnostic evaluations of the condition of the hardware. Proper operation of these modules is indicated by LEDs on the front surface of the DSIOs, and on the top horizontal surface of the PSIOs.

**RED LED** — Blinking continuously at a 1 to 2 second rate indicates proper operation. Lighted continuously indicates a problem requiring replacement of module. Off continuously indicates power should be checked. If there is no input power, check fuses. If fuse is bad, check for shorted secondary of transformer, tripped circuit breaker or bad module. On the PSIO module, if the light is blinking at a rate of twice per second, the module should be replaced.

**GREEN LED** — On a PSIO module, this is the green LED closest to COMM connectors. The other green LED on module indicates external communications, when used. Green LED should always be blinking when power is on. It indicates modules are communicating properly. If green LED is not blinking, check red LED. If red LED is normal, check module address switches. Correct addresses are as follows:

PSIO-1 (Processor Module)	— 01
CPM-A1 (Protection Module)	— 21
CPM-A2 (Protection Module)	— 29
CPM-B1 (Protection Module)	— 37
DSIO (EXV Driver Module)	— 50
DSIO-HV (Relay Module)	— 62
PSIO-2 (12/6 I/O Module)	— 74

The first number of the address for a DSIO module should be set on the switch closest to the silver mounting plate.

If *all* modules indicate communication failure, check COMM plug on PSIO-1 module for proper seating. If a good connection is assured and condition persists, replace PSIO-1 module.

If only a DSIO module indicates communication failure, check COMM plug on that module for proper seating. If a good connection is assured and the condition persists, replace the DSIO module.

All system operating intelligence rests in the PSIO-1 module, the module that controls unit. This module monitors conditions through input and output ports and through DSIO modules (high-voltage relay module and EXV driver module).

The machine operator communicates with microprocessor through keypad and display module. Communication between PSIO and other modules is accomplished by a 3-wire sensor bus. These 3 wires run in parallel from module to module.

On sensor bus terminal strips, terminal 1 of PSIO module is connected to terminal 1 of each of the other modules. Terminals 2 and 3 are connected in the same manner. See Fig. 24. If a terminal 2 wire is connected to terminal 1, system does not work.

In the 30GX,HX control box, the processor module (PSIO-1), DSIO-HV, keypad and display module and 5 vdc power supply are all powered from a common 21 vac power source (PSIO-1 and HSIO powered from 24 vac source on 30HX units) which connects to terminals 1 and 2 of the power connector on each module. A separate source of 21 vac power is used to power the PSIO-2 module and liquid level sensor heaters. A separate 12.5 vdc power source is used for the DSIO-EXV module through terminals 1 and 2 on the power connector. The CPM modules are connected to 24 vac power sources. Refer to Table 43 for control troubleshooting information.

**Carrier Comfort Network (CCN) Interface** — The 30GX,HX chiller units can be connected to the CCN if desired. The communication bus wiring is a shielded, 3-conductor cable with drain wire and is supplied and installed in the field. The system elements are connected to the communication bus in a daisy chain arrangement as shown in Fig. 24. The positive pin of each system element communication connector must be wired to the positive pins of the system elements on either side of it. This is also required for the negative and signal ground pins of each system element. Wiring connections for CCN should be made at the COMM1 plug on the PSIO-1 module. Consult the CCN Contractor's Manual for further information.

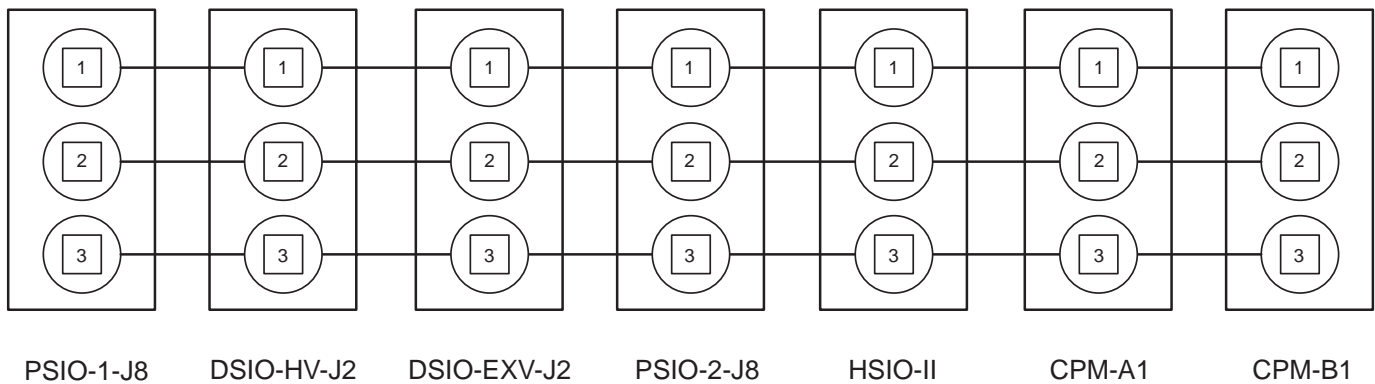
**NOTE:** Conductors and drain wire must be 20 AWG (American Wire Gage) minimum stranded, tinned copper. Individual conductors must be insulated with PVC, PVC/nylon, vinyl, Teflon, or polyethylene. An aluminum/polyester 100% foil shield and an outer jacket of PVC, PVC/nylon, chrome vinyl, or Teflon with a minimum operating temperature range of -20 C to 60 C is required. Wire manufactured by Alpha (2413 or 5463), American (A22503), Belden (8772), or Columbia (02525) meets the above mentioned requirements.

It is important when connecting to a CCN communication bus that a color coding scheme be used for the entire network to simplify the installation. It is recommended that red be used for the signal positive, black for the signal negative, and white for the signal ground. Use a similar scheme for cables containing different colored wires.

At each system element, the shields of its communication bus cables must be tied together. If the communication bus is entirely within one building, the resulting continuous shield must be connected to a ground at one point only. If the communication bus cable exits from one building and enters another, the shields must be connected to grounds at the lightning suppressor in each building where the cable enters or exits the building (one point per building only). To connect the unit to the network:

1. Turn off power to the control box.
2. Cut the CCN wire and strip the ends of the red (+), white (ground), and black (-) conductors. (Substitute appropriate colors for different colored cables.)





**Fig. 24 — Sensor Bus Wiring (Communications)**

**Table 43 — Compressor Control Troubleshooting**

SYMPTOMS	CAUSE	REMEDY
<b>COMPRESSOR DOES NOT RUN</b>	Power line open Control fuse open High-Pressure Switch (HPS) tripped  Tripped motor overload Loose terminal connection Improperly wired controls Low line voltage  Compressor motor defective  Seized compressor Pre-lubrication not successful	Check main disconnect. Check control circuit for ground or short. Replace fuse. Move LOCAL/OFF/REMOTE switch to OFF position then back to LOCAL or REMOTE position. Check the controls. Find cause of trip. Reset overload. Check connections. Check wiring and rewire. Check line voltage. Determine location of voltage drop and remedy deficiency. Check motor winding for open or short. Replace compressor if necessary. Replace compressor. Check oil pump operation, oil pressure transducer, verify oil level/flow switch operation.
<b>COMPRESSOR CYCLES OFF ON LOW PRESSURE</b>	Loss of charge Bad transducer Low refrigerant charge Failed expansion device	Repair leak and recharge. Replace transducer. Add refrigerant. Repair/replace as needed.
<b>COMPRESSOR SHUTS DOWN ON HIGH PRESSURE CONTROL</b>	High-pressure switch erratic in action Compressor discharge valve partially closed Condenser fan(s) not operating (air cooled units) Condenser coil plugged or dirty (air cooled units) Condenser water valve not operating (water cooled units) Circuit overcharged Liquid valve closed*	Replace switch. Open valve or replace if defective. Check wiring. Repair or replace motor(s) if defective. Clean coil. Check wiring. Repair or replace valve if defective  Clean condenser. Open valve or replace if defective.
<b>UNIT OPERATES LONG OR CONTINUOUSLY</b>	Low refrigerant charge Control contacts fused Partially plugged or plugged expansion valve or filter drier Defective insulation Service load exceeding design capacity Inefficient compressor	Add refrigerant. Replace control. Clean or replace.  Replace or repair. Keep doors and windows closed. Check loader solenoid valves. Replace if necessary.
<b>SYSTEM NOISES</b>	Piping vibration Expansion valve hissing  Compressor noisy	Support piping as required. Add refrigerant. Check for plugged liquid line filter drier. Replace compressor (worn bearings). Check for loose compressor bolts securing compressor to cooler.
<b>COMPRESSOR LOSES OIL</b>	Leak in system Mechanical damage to rotors	Find and repair leak. Replace compressor.
<b>HOT LIQUID LINE</b>	Shortage of refrigerant due to leak	Repair leak and recharge.
<b>FROSTED LIQUID LINE</b>	Shutoff valve partially closed or restricted	Open valve or remove restriction.
<b>COMPRESSOR LOADERS NOT WORKING PROPERLY</b>	Burned out coil Defective capacity control valve Miswired solenoid	Replace coil. Replace valve. Rewire correctly.

\*30GX251, 265 sizes have two Circuit A discharge and liquid valves.

3. Remove the 4-pin female plug from the PSIO-1 COMM1 plug and connect the red wire to terminal 1 of the plug, the white wire to terminal 2, and the black wire to terminal 3.
4. Insert the plug back into the COMM1 plug.

**IMPORTANT:** A shorted CCN bus cable will prevent some routines from running and may prevent the unit from starting. If abnormal conditions occur, unplug the connector. If conditions return to normal, check the CCN connector and cable. Run new cable if necessary. A short in one section of the bus can cause problems with all system elements on the bus.

#### PROCESSOR MODULE (PSIO-1)

**Inputs** — Each input channel has 3 terminals; only 2 of the terminals are used. Application of machine determines which terminals are used. Always refer to the individual unit wiring for terminal numbers.

**Outputs** — Output is 20 vdc or 4 to 20 mA. There are 3 terminals, only 2 of which are used, depending on the application. Refer to unit the wiring diagram.

**NOTE:** The 12/6 Input/Output module (PSIO-2) has identical input and output configurations as the PSIO-1. There is NO operating software in the PSIO-2 module.

#### HIGH VOLTAGE RELAY MODULE (DSIO-HV)

**Inputs** — Inputs on strip J3 are discrete inputs (ON/OFF). When 24-vac power is applied across the 2 terminals in a channel it reads the input as an On signal. Zero volts input is read as an Off signal.

**Outputs** — Terminal strips J4 and J5 are internal relays whose coils are signaled to be turned on and off by the micro-processor (PSIO-1). The relays switch the circuit to which they are connected. No power is supplied to these connections by DSIO-HV module.

**Replacing Defective Processor Module** — The PSIO-1 module replacement part number is 30GX500110. The unit model and serial numbers are printed on the unit nameplate located on an exterior corner post (30GX) or the corner of the control box (30HX). The proper software and unit configuration data is factory installed by Carrier in the replacement module. Therefore, when ordering a replacement processor module (PSIO-1), specify the replacement part number, *full* unit model number, and serial number. If these numbers are not provided, the replacement module will be downloaded with the base software. The base software settings must be reconfigured by the installer in the field.

Verify the existing PSIO-1 module is defective by using the procedure described in the Control Modules section.

Refer to Start-up Checklist for 30GX,HX Liquid Chillers (completed at time of original start-up) found in the job folder. This information is needed later in this procedure. If the checklist does not exist, fill out the current factory and service configuration codes (   ) sections on a new checklist. Tailor the various options and configurations as needed for this particular installation.

### ⚠ CAUTION

Electrical shock can cause personal injury. Disconnect all electrical power before servicing.

2. Remove the defective PSIO-1 module by removing its mounting screws with a Phillips screwdriver, and removing the module from the control box. Save the screws for later use.
3. Use a small screwdriver to set the address switches S1 and S2 on the new PSIO module to exactly match the settings on the defective module.
4. Package the defective module in the carton of the new module for return to Carrier.
5. Mount the new module in the unit control box using a Phillips screwdriver and the screws saved in Step 2.
6. Reinstall all 6 wire connectors, the green ground wire, and the communications drain wire.
7. Carefully check all wiring connections before restoring power.
8. Verify the LOCAL/OFF/REMOTE switch is in the OFF position.
9. Restore control power. Verify the red and green lights on top of the PSIO-1 and on front of each DSIO module respond as described in Control Modules section. The keypad and display module should also begin its rotating display.
 

Using the keypad and display module, press   to verify that the software version number matches the ER (engineering requirement) number shown on the PSIO-1 label.
10. Press  , scroll down one level at a time, and check the 3 factory and 2 service configuration codes as recorded on checklist. These codes must exactly match the codes stored in the previous PSIO-1 module for proper unit operation. These should already be downloaded if the proper information was supplied when ordering the replacement module. If the codes do not match, the codes must be entered by the procedure described in the factory service code section of Table 22.
11. Once all codes have been verified, and all configurations, set points, and schedules re-entered, return the LOCAL/OFF/REMOTE switch to its previous position.

**Winter Shutdown Preparation** — At the end of each cooling season the fluid should be drained from the system. However, due to the cooler circuiting, some fluid will remain in the cooler after draining. To prevent freeze-up damage to the cooler tubes perform the following procedure.

1. If accessory cooler heaters have been installed, deenergize the heaters to prevent damage and possible safety hazards when draining, or when there is no liquid in the system. Remove Fuse 1 to deenergize the heaters. Drain the fluid from the system.
2. Isolate the cooler from the rest of the system with water shut off valves.
3. Fill the cooler with an appropriate amount of uninhibited ethylene glycol solution (or other suitable corrosion-inhibitive antifreeze) for 15° F (8.3° C) below the expected low ambient conditions.
4. Leave the cooler filled with the antifreeze solution for the winter, or drain if desired. Be sure to deenergize heaters (if installed) as explained in Step 1 to prevent damage. Use an approved method of disposal when removing the antifreeze solution.

1. Check that all power to unit is off. Carefully disconnect all wires from defective module by unplugging the 6 connectors. It is not necessary to remove any of the individual wires from the connectors. Remove the screws securing the green ground wire and communication drain wire. Save the screws.

## PRE-START-UP PROCEDURE

**IMPORTANT:** Before beginning Pre-Start-Up or Start-Up, complete the Start-Up Checklist for the 30GX,HX Liquid Chillers on pages CL-1 to CL-8. This Checklist assures proper start-up of the chiller, and provides a record of unit condition, application requirements, system information and operation at initial start-up. The checklist should be removed from the manual and kept with the job file for future reference.

**IMPORTANT:** DO NOT ATTEMPT TO START THE CHILLER UNTIL THE FOLLOWING CHECKS HAVE BEEN COMPLETED.

### System Check

1. Check all auxiliary components such as the chilled fluid circulating pump, air-handling equipment, or other equipment to which the chiller supplies liquid. Consult the manufacturer's instructions. If the unit has field-installed accessories, be sure all are properly installed and wired correctly. Refer to the unit wiring diagrams.
2. Check the cooler flow switch for proper configuration and operation (  8  STAT from HSIO). Ensure the switch closes when the pump is on and opens when the pump is turned off. A flow switch must be installed.
3. Open the discharge and liquid valves in each circuit. The discharge shutoff valves are in-line ball type and are open when parallel with the refrigerant flow.
4. If factory-installed option is installed, open the suction service valves in each circuit. Service valve is located below the compressor in the cooler suction connection flange.
5. Open the oil shutoff valves located by the oil pre-filter. Open bubbler tube valve on 30HX machines equipped with economizers.
6. Check the tightness of all electrical connections. Check incoming power supply for proper nameplate voltage.
7. Check to ensure the unit is level per the installation instructions.
8. Check the incoming power supply for proper phasing. This can be done by turning on both the line voltage and control voltage power supplies. Leave the LOCAL/OFF/REMOTE switch in the OFF position. If the incoming power is not phased correctly, the CPM will generate an alarm for voltage phase reversal. Press  3  STAT for Circuit A and  5  STAT for Circuit B at the HSIO to check for this alarm. Scroll up and locate the Feedback value (displayed in units of volts). If a value of 7.0 appears, a voltage phase reversal has been identified and requires incoming power supply phase change. If this is the case, shut down all power supplies and switch any 2 incoming power leads at the control box terminal block.

### **⚠ CAUTION**

DO NOT make any changes to the factory installed compressor power wiring in the control box or at the compressor junction box. Doing so will cause permanent damage to the compressor and will require compressor replacement. Proper phasing has already been checked at the factory.

For those units with 2 incoming terminal blocks, the voltage sequence is sensed at one terminal block only. Check the phasing to ensure that both circuits match. If the incoming power is still phased incorrectly at the

second terminal block, a current phase reversal alarm will be generated when an attempt is made to start this compressor. The compressor will be shut down within 15 milliseconds. To correct this, interchange 2 power leads at this terminal block only.

9. Check all field configuration data and set points.
10. Enter correct date, time, and operating schedule(s).
11. Verify operation of solenoids, pumps, valves, compressors, fans, etc. as listed in the Checklist.
12. Open condenser water valves. Check condenser water pump for proper operation (30HX).

## START-UP AND OPERATION

**Actual Start-Up** — *Actual start-up should be done only under supervision of a qualified refrigeration mechanic and qualified Carrier Comfort Network personnel.*

1. Set leaving fluid temperature. No cooling range adjustment is necessary.
2. Start chilled fluid pump and condenser pump (30HXC) if not controlled by unit.
3. Switch LOCAL/OFF/REMOTE switch to LOCAL or REMOTE.
4. Provided there is a load on the chiller, allow the machine to operate and confirm that everything is functioning properly. Verify that the leaving fluid temperature agrees with the cooling set point (1 or 2), or if reset is being used, the modified set point. Chiller is controlling to the Control Point displayed under  2  STAT.

**Operating Sequence** — The chiller is started by switching the LOCAL/OFF/REMOTE switch to either LOCAL or REMOTE. On a command for cooling, the oil pump is turned on to start the pre-lubrication process. After 20 seconds, the oil solenoid is opened and the control reads the oil pressure from the transducer and determines if sufficient pressure has been built up. If there is not sufficient pressure, an alarm is generated after the second attempt and the compressor is not started.

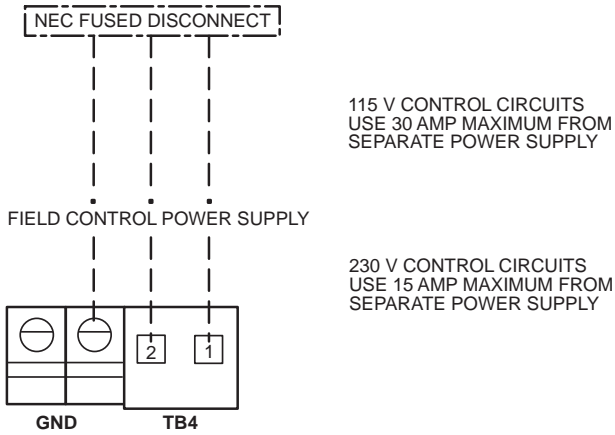
Upon building pressure, the compressor is allowed to start. For across-the-line (XL) start chillers, the compressor starts and comes up to full speed within 1 to 3 seconds. For Wye-Delta start chillers, contactors 1M and S (starter contactor assembly) are closed and the compressor is started in a Wye configuration. This method reduces the locked rotor current requirements by approximately 60% while maintaining enough torque to bring the compressor up to full speed.

After 5 seconds, the CPM module switches out contactor S and brings in contactor 2M, which runs the motor in a Delta configuration (same configuration in which XL units run). The oil pump will shut off within 10 seconds after the compressor is started. Once the compressor is successfully running, the control loads the compressor and adds additional stages of capacity as needed to satisfy the leaving fluid set point. Head pressure is controlled by fan cycling (30GX) or can be controlled with a field installed accessory Motor-master® III controller (30GX) or field installed condenser water valves (30HX).

If cooler pump control is enabled, the cooler pump is started. If condenser pump control (30HXC) is enabled, the condenser pump is started (Type 1).

## FIELD WIRING

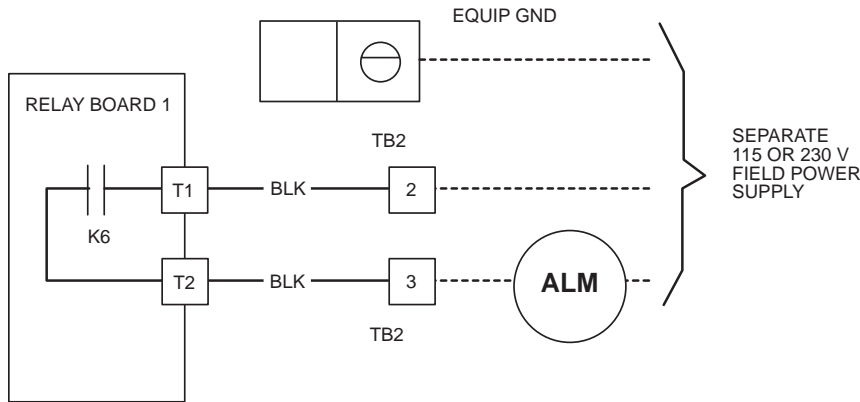
Field wiring is shown in Fig. 25-37.



**Fig. 25 — Power Supply Wiring**

## LEGEND FOR FIG. 25-37

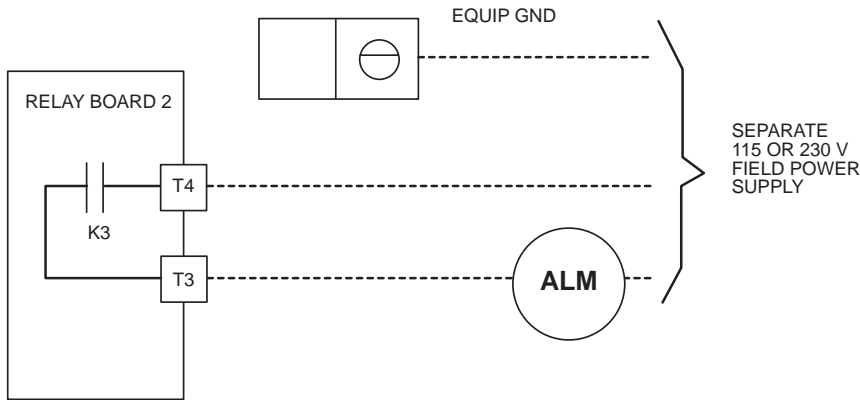
<b>ALM</b>	— Alarm
<b>C</b>	— Contactor
<b>CFC</b>	— Condenser Fan Contactor
<b>CPR</b>	— Condenser Pump Relay
<b>CWP</b>	— Chilled Water Pump
<b>DSIO</b>	— High Voltage Relay Module
<b>EQUIP</b>	— Equipment
<b>EXV</b>	— Electronic Expansion Valve
<b>FU</b>	— Fuse
<b>GFI-CO</b>	— Ground Fault Interrupter Convenience Outlet
<b>GND</b>	— Ground
<b>NEC</b>	— National Electrical Code
<b>PL</b>	— Plug
<b>PSIO</b>	— Processor Sensor Input/Output Module
<b>RB</b>	— Relay Board
<b>TB</b>	— Terminal Block
---	Field-Wired
—	Factory Wired



MAX. LOAD ALLOWED FOR THE ALARM RELAY IS  
125 VA SEALED, 1250 VA INRUSH AT 115 OR 230 VOLT.

### FIELD SUPPLIED

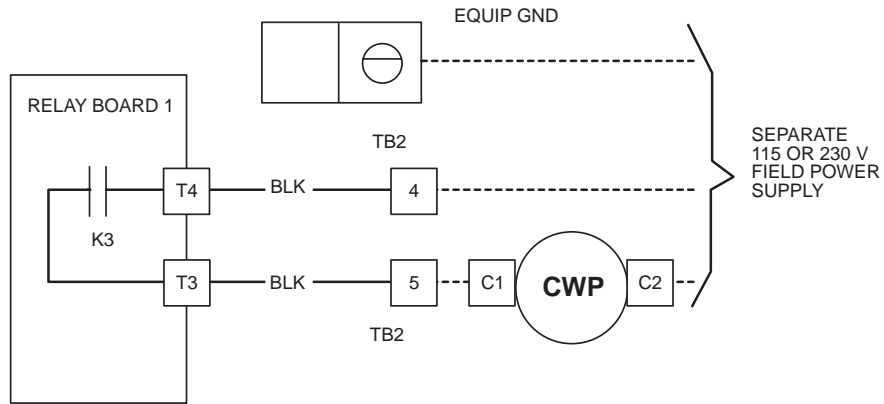
**Fig. 26 — Remote Alarm Relay Accessory Wiring; 30HXA,C**



MAX. LOAD ALLOWED FOR THE ALARM RELAY IS  
125 VA SEALED, 1250 VA INRUSH AT 115 OR 230 VOLT.

### FIELD SUPPLIED

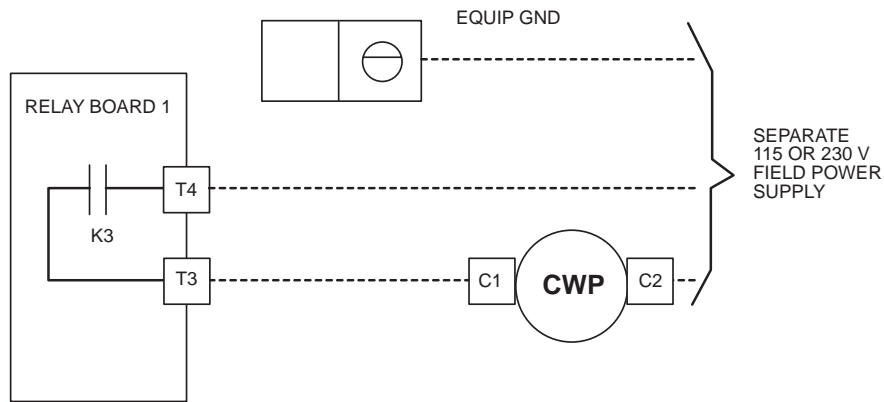
**Fig. 27 — Remote Alarm Relay Accessory Wiring; 30GX**



MAX. LOAD ALLOWED FOR THE CWP RELAY IS  
125 VA SEALED, 1250 VA INRUSH AT 115 OR 230 VOLT.

**ACCESSORY ONLY**

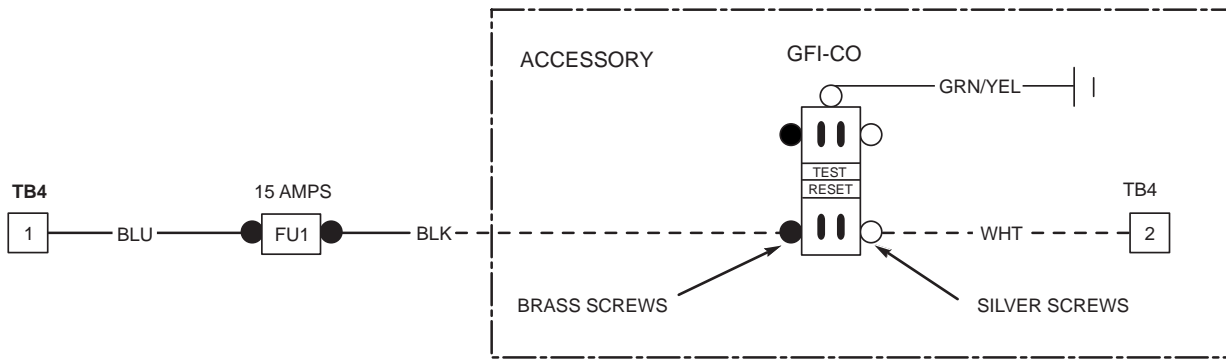
**Fig. 28 — Chilled Water Pump Relay Wiring; 30HXA,C**



MAX. LOAD ALLOWED FOR THE CWP RELAY IS  
125 VA SEALED, 1250 VA INRUSH AT 115 OR 230 VOLT.

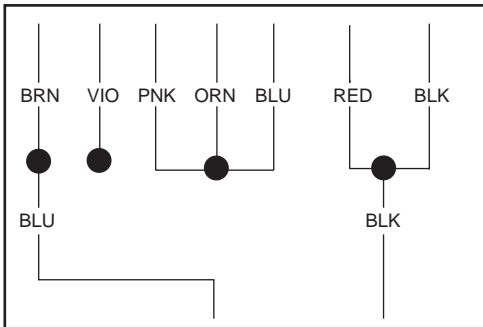
**ACCESSORY ONLY**

**Fig. 29 — Chilled Water Pump Relay Wiring; 30GX**

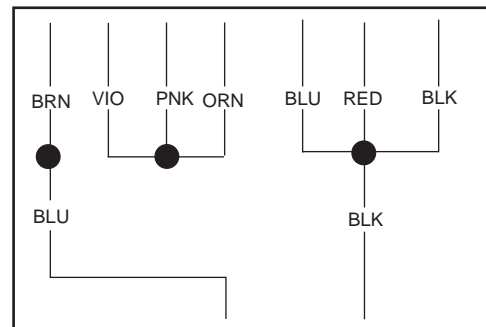


**Fig. 30 — Ground Fault Interrupter-Convenience Outlet Accessory Wiring**

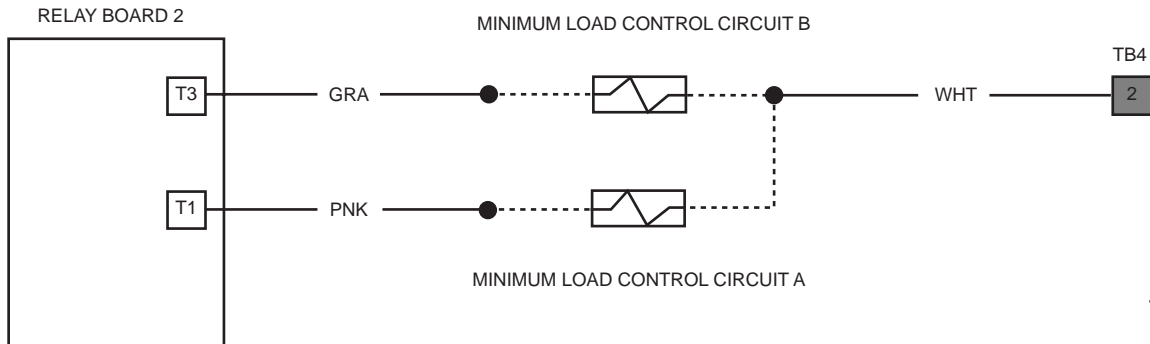
**230V CONTROL CIRCUIT WIRING**



**115V CONTROL CIRCUIT WIRING**

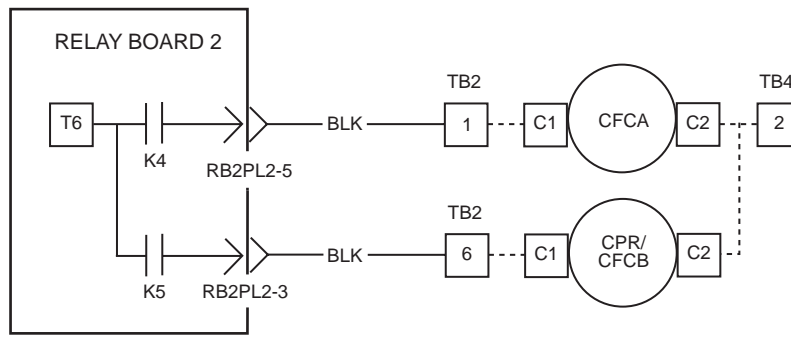


**Fig. 31 — Oil Pump Motor Junction Box Wiring**



NOTE: Gray, Pink, and White wires are included in the control box as part of the factory wire harness. Field supplied and installed wire is needed from control box to solenoid valves.

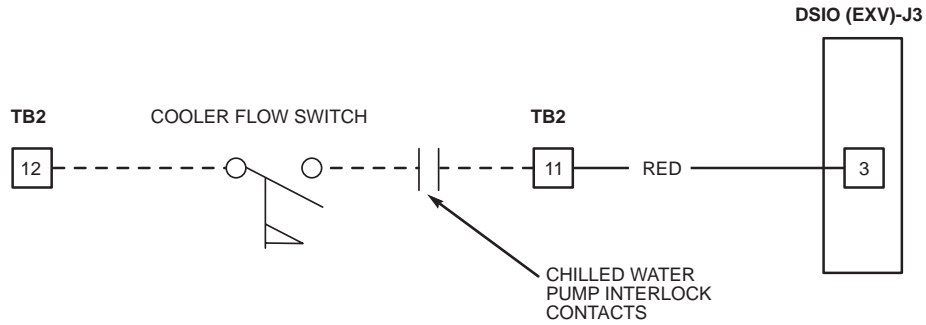
**Fig. 32 — Minimum Load Valve Accessory Wiring**



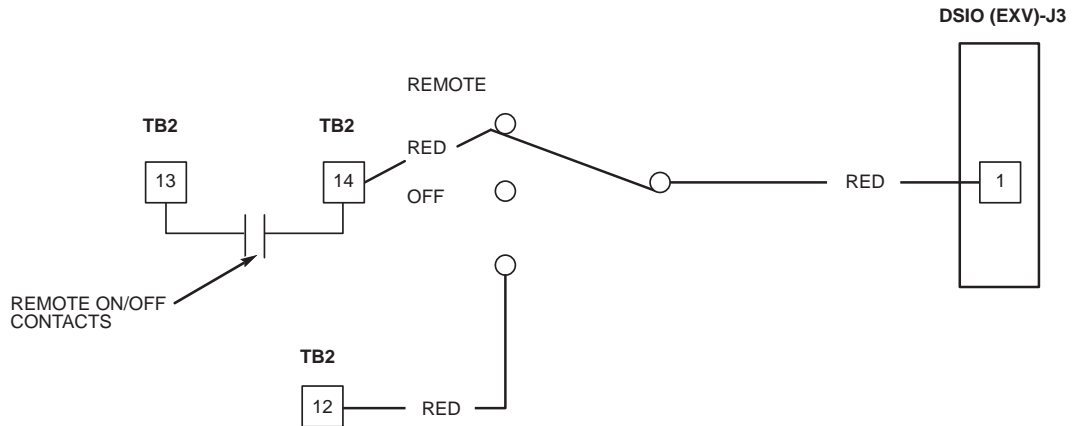
MAX. LOAD ALLOWED AT TB2-1 AND TB2-6 IS  
125 VA SEALED, 1250 VA INRUSH AT 115 OR 230 VOLTS.

**FIELD SUPPLIED**

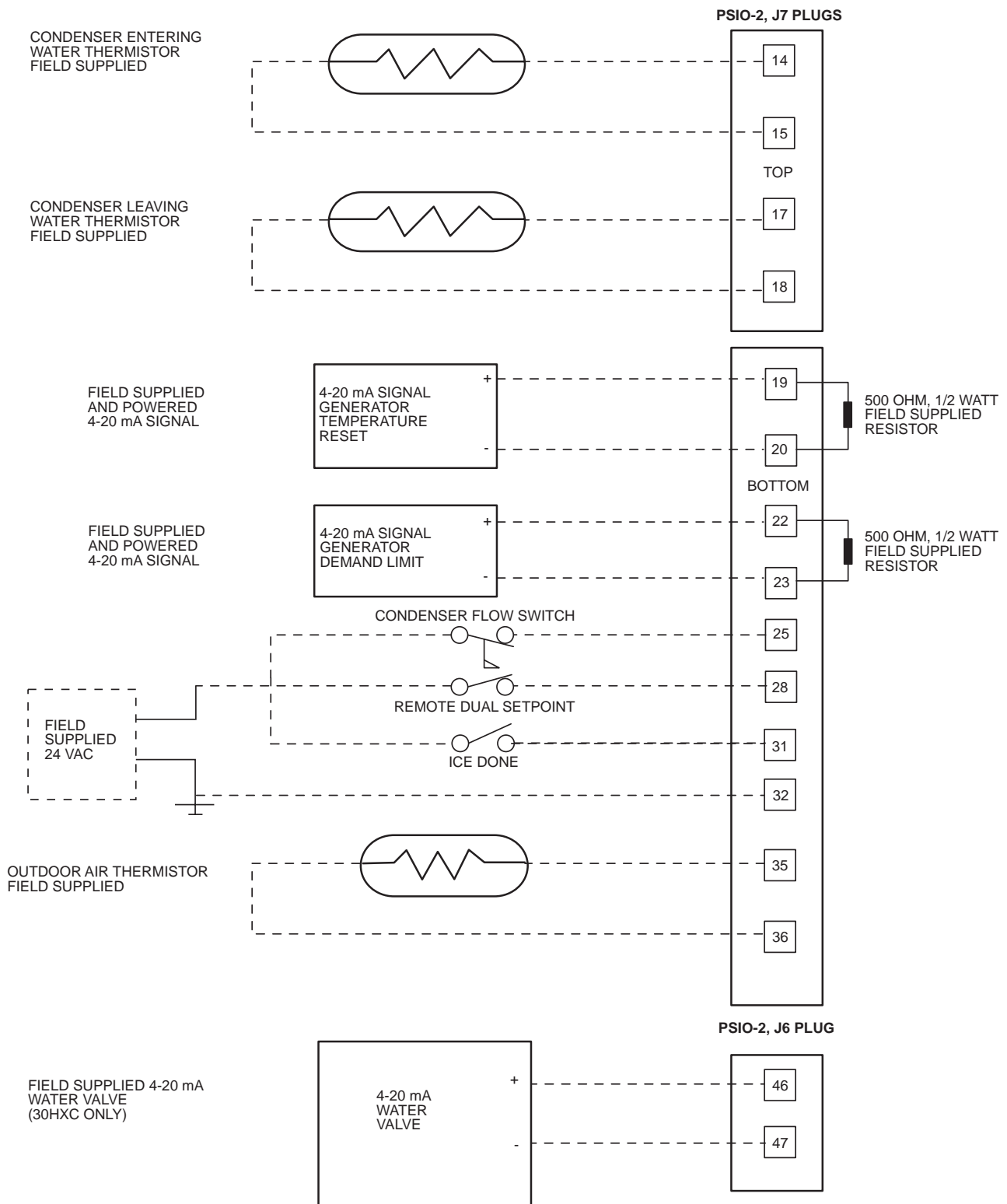
**Fig. 33 — Condenser Pump Relay Wiring, 30HXC and Remote Condenser Fan On/Off Wiring, 30HXA**



**Fig. 34 — Chilled Water Interlock and Flow Switch Input Wiring**

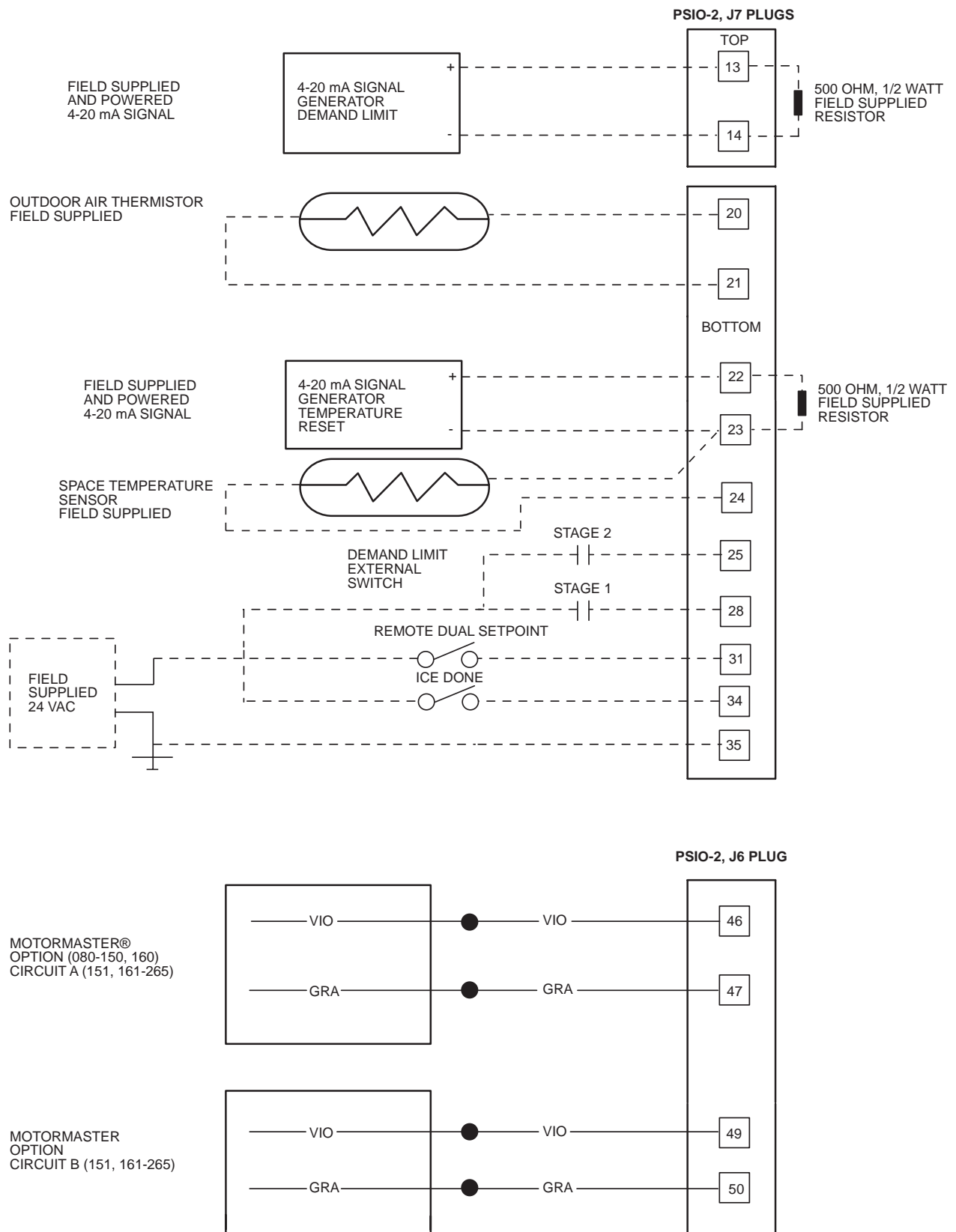


**Fig. 35 — Remote On/Off Switch Input Wiring**



**Fig. 36 — PSIO-2 Wiring for Accessories and Field-Installed Options, 30HX Units**





**Fig. 37 — PSIO-2 Wiring for Accessories and Field-Installed Options, 30GX Units**

**APPENDIX A**

**Compressor Must Trip Amps (Determined by CPM Modules)**

<b>COMPRESSOR MUST TRIP AMPS 2-COMPRESSOR UNITS</b>		
<b>Unit Size</b>	<b>Unit Voltage</b>	<b>Compressor A1, B1 Must Trip Amps</b>
<b>30GX080</b>	575-3-60	98, 82
	380-3-60	148,124
	208/230-3-60	270,226
	460-3-60	122,102
	230-3-50	256,212
<b>30GX090</b>	380/415-3-50	156,128
	575-3-60	120, 82
	380-3-60	180,124
	208/230-3-60	328,226
	460-3-60	148,102
<b>30GX105</b>	230-3-50	310,212
	380/415-3-50	188,128
	230-3-50	344,238
	380/415-3-50	208,144
	575-3-60	134, 92
<b>30GX106</b>	380-3-60	202,140
	208/230-3-60	368,254
	460-3-60	168,114
	230-3-50	344,238
	380/415-3-50	208,144
<b>30GX115</b>	575-3-60	162, 92
	380-3-60	246,140
	208/230-3-60	448,254
	460-3-60	204,114
	230-3-50	418,238
<b>30GX125</b>	380/415-3-50	254,144
	575-3-60	162,110
	380-3-60	246,168
	208/230-3-60	448,306
	460-3-60	204,138
<b>30GX136</b>	230-3-50	418,288
	380/415-3-50	254,174
	575-3-60	162,134
	380-3-60	246,202
	208/230-3-60	448,368
<b>30GX150</b>	460-3-60	204,168
	230-3-50	418,344
	380/415-3-50	254,208
	230-3-50	344,520
	380/415-3-50	208,314
<b>30GX151</b>	575-3-60	198,134
	380-3-60	300,202
	208/230-3-60	546,368
	460-3-60	240,168
<b>30GX160</b>	230-3-50	418,520
	380/415-3-50	254,314
	575-3-60	198,162
<b>30GX161</b>	380-3-60	300,246
	208/230-3-60	546,448
	460-3-60	248,204
	230-3-50	520,418
	380/415-3-50	314,254
<b>30GX175</b>	230-3-50	520,520
	380/415-3-50	314,314
<b>30GX176</b>	575-3-60	198,198
	380-3-60	300,300
	208/230-3-60	546,546
	460-3-60	248,248
<b>30HXA076</b>	575-3-60	82, 82
	380-3-60	124,124
	346-3-50	140,140
	208/230-3-60	226,226
	460-3-60	102,102
	230-3-50	212,212
<b>30HXA086</b>	380/415-3-50	128,128
	575-3-60	98, 82
	380-3-60	148,124
	346-3-50	170,140
	208/230-3-60	270,226
	460-3-60	122,102

<b>COMPRESSOR MUST TRIP AMPS 2-COMPRESSOR UNITS</b>		
<b>Unit Size</b>	<b>Unit Voltage</b>	<b>Compressor A1, B1 Must Trip Amps</b>
<b>30HXA096</b>	575-3-60	120, 82
	380-3-60	180,124
	346-3-50	206,140
	208/230-3-60	328,226
	460-3-60	148,102
	230-3-50	310,212
<b>30HXA106</b>	380/415-3-50	188,128
	575-3-60	144, 82
	380-3-60	218,124
	346-3-50	250,140
	208/230-3-60	400,226
	460-3-60	180,102
<b>30HXA116</b>	230-3-50	376,212
	380/415-3-50	228,128
	575-3-60	144, 98
	380-3-60	218,148
	346-3-50	250,170
	208/230-3-60	400,270
<b>30HXA126</b>	460-3-60	180,122
	230-3-50	376,256
	380/415-3-50	228,156
	575-3-60	144,120
	380-3-60	218,180
	346-3-50	250,206
<b>30HXA136</b>	208/230-3-60	400,328
	460-3-60	180,148
	230-3-50	376,310
	380/415-3-50	228,188
	575-3-60	176,120
	380-3-60	266,180
<b>30HXA146</b>	346-3-50	306,206
	208/230-3-60	486,328
	460-3-60	220,148
	230-3-50	462,310
	380/415-3-50	280,188
	575-3-60	176,144
<b>30HXA161</b>	380-3-60	266,218
	346-3-50	306,250
	208/230-3-60	486,400
	460-3-60	220,180
	230-3-50	462,376
	380/415-3-50	280,228
<b>30HXA171</b>	575-3-60	198,134
	380-3-60	300,202
	346-3-50	344,228
	208/230-3-60	546,368
	460-3-60	248,168
	230-3-50	520,344
<b>30HXA186</b>	380/415-3-50	314,208
	575-3-60	162,198
	380-3-60	246,300
	346-3-50	278,344
	208/230-3-60	448,546
	460-3-60	204,248
<b>30HXA096</b>	230-3-50	418,520
	380/415-3-50	254,314
	575-3-60	198,198
	380-3-60	300,300
	346-3-50	344,344
	208/230-3-60	546,546
<b>30HXA106</b>	460-3-60	248,248
	230-3-50	418,520
	380/415-3-50	254,314
	575-3-60	198,198
	380-3-60	300,300
	346-3-50	344,344
<b>30HXA116</b>	208/230-3-60	448,546
	460-3-60	204,248
	230-3-50	418,520
	380/415-3-50	254,314
	575-3-60	198,198
	380-3-60	300,300
<b>30HXA126</b>	346-3-50	344,344
	208/230-3-60	546,546
	460-3-60	248,248
	230-3-50	520,520
	380/415-3-50	314,314
	575-3-60	198,198

**APPENDIX A (cont)**  
**Compressor Must Trip Amps (Determined by CPM Modules) (cont)**

<b>COMPRESSOR MUST TRIP AMPS 2-COMPRESSOR UNITS</b>		
<b>Unit Size</b>	<b>Unit Voltage</b>	<b>Compressor A1, B1 Must Trip Amps</b>
<b>30HXC076</b>	575-3-60	56, 56
	380-3-60	84, 84
	346-3-50	96, 96
	208/230-3-60	154,154
	460-3-60	70, 70
	230-3-50	144,144
	380/415-3-50	88, 88
<b>30HXC086</b>	575-3-60	68, 56
	380-3-60	102, 84
	346-3-50	116, 96
	208/230-3-60	186,154
	460-3-60	84, 70
	230-3-50	176,144
	380/415-3-50	106, 88
<b>30HXC096</b>	575-3-60	82, 56
	380-3-60	124, 84
	346-3-50	140, 96
	208/230-3-60	226,154
	460-3-60	104, 70
	230-3-50	212,144
	380/415-3-50	128, 88
<b>30HXC106</b>	575-3-60	100, 56
	380-3-60	150, 84
	346-3-50	168, 96
	208/230-3-60	274,154
	460-3-60	124, 70
	230-3-50	254,144
	380/415-3-50	154, 88
<b>30HXC116</b>	575-3-60	100, 68
	380-3-60	150,102
	346-3-50	168,116
	208/230-3-60	274,186
	460-3-60	124, 84
	230-3-50	254,176
	380/415-3-50	154,106
<b>30HXC126</b>	575-3-60	100, 82
	380-3-60	150,124
	346-3-50	168,140
	208/230-3-60	274,226
	460-3-60	124,104
	230-3-50	254,212
	380/415-3-50	154,128

<b>COMPRESSOR MUST TRIP AMPS 2-COMPRESSOR UNITS</b>		
<b>Unit Size</b>	<b>Unit Voltage</b>	<b>Compressor A1, B1 Must Trip Amps</b>
<b>30HXC136</b>	575-3-60	120, 82
	380-3-60	180,124
	346-3-50	204,140
	208/230-3-60	328,226
	460-3-60	148,104
	230-3-50	308,212
	380/415-3-50	186,128
<b>30HXC146</b>	575-3-60	120,100
	380-3-60	180,150
	346-3-50	204,168
	208/230-3-60	328,274
	460-3-60	148,124
	230-3-50	308,254
	380/415-3-50	186,154
<b>30HXC161</b>	575-3-60	130, 90
	380-3-60	196,136
	346-3-50	220,152
	208/230-3-60	358,246
	460-3-60	162,112
	230-3-50	332,228
	380/415-3-50	202,138
<b>30HXC171</b>	575-3-60	108,130
	380-3-60	164,196
	346-3-50	182,220
	208/230-3-60	298,358
	460-3-60	136,162
	230-3-50	274,332
	380/415-3-50	166,202
<b>30HXC186</b>	575-3-60	130,130
	380-3-60	196,196
	346-3-50	220,220
	208/230-3-60	358,358
	460-3-60	162,162
	230-3-50	332,332
	380/415-3-50	202,202

**APPENDIX A (cont)**

**Compressor Must Trip Amps (Determined by CPM Modules) (cont)**

<b>COMPRESSOR MUST TRIP AMPS 3-COMPRESSOR UNITS</b>		
<b>Unit Size</b>	<b>Unit Voltage</b>	<b>Compressor A1, A2, B1 Must Trip Amps</b>
<b>30GX205</b>	230-3-50	418,238,520
	380/415-3-50	254,144,314
<b>30GX206</b>	575-3-60	198, 92,162
	380-3-60	300,140,246
	208/230-3-60	546,254,448
	460-3-60	248,114,204
<b>30GX225</b>	230-3-50	520,288,520
	380/415-3-50	314,174,314
<b>30GX226</b>	575-3-60	198,110,198
	380-3-60	300,168,300
	208/230-3-60	546,306,546
	460-3-60	248,138,248
	230-3-50	520,288,520
	380/415-3-50	314,174,314
<b>30GX250</b>	230-3-50	520,418,520
	380/415-3-50	314,254,314
<b>30GX251</b>	575-3-60	198,198,162
	380-3-60	300,300,246
	208/230-3-60	546,546,448
	460-3-60	248,248,204
<b>30GX265</b>	575-3-60	198,198,198
	380-3-60	300,300,300
	208/230-3-60	546,546,546
	460-3-60	248,248,248
	230-3-50	520,520,520
<b>30HXA206</b>	380/415-3-50	314,314,314
	575-3-60	162, 92,198
	380-3-60	246,138,300
	346-3-50	278,158,344
	208/230-3-60	448,254,546
	460-3-60	204,116,248
<b>30HXA246</b>	230-3-50	418,238,520
	380/415-3-50	254,144,314
	575-3-60	198,134,198
	380-3-60	300,202,300
	346-3-50	344,228,344
	208/230-3-60	546,368,546
<b>30HXA261</b>	460-3-60	248,168,248
	230-3-50	520,344,520
	380/415-3-50	314,208,314
	575-3-60	198,162,198
	380-3-60	300,246,300

<b>COMPRESSOR MUST TRIP AMPS 3-COMPRESSOR UNITS</b>		
<b>Unit Size</b>	<b>Unit Voltage</b>	<b>Compressor A1, A2, B1 Must Trip Amps</b>
<b>30HXA261</b>	575-3-60	198,162,198
	380-3-60	300,246,300
	346-3-50	344,278,344
	208/230-3-60	546,448,546
	460-3-60	248,204,248
	230-3-50	520,418,520
<b>30HXA271</b>	380/415-3-50	314,254,314
	575-3-60	198,198,198
	380-3-60	300,300,300
	346-3-50	344,344,344
	208/230-3-60	546,546,546
	460-3-60	248,248,248
<b>30HXC206</b>	230-3-50	520,520,520
	380/415-3-50	314,314,314
	575-3-60	108, 62,130
	380-3-60	164, 92,196
	346-3-50	182,104,220
	208/230-3-60	298,168,358
<b>30HXC246</b>	460-3-60	136, 76,162
	230-3-50	274,156,332
	380/415-3-50	166, 94,202
	575-3-60	130, 90,130
	380-3-60	196,136,196
	346-3-50	220,152,220
<b>30HXC261</b>	208/230-3-60	358,246,358
	460-3-60	162,112,162
	230-3-50	332,228,332
	380/415-3-50	202,138,202
	575-3-60	130,108,130
	380-3-60	196,164,196
<b>30HXC271</b>	346-3-50	220,182,220
	208/230-3-60	358,298,358
	460-3-60	162,136,162
	230-3-50	332,274,332
	380/415-3-50	202,166,202
	575-3-60	130,130,130
<b>30HXC206</b>	380-3-60	196,196,196
	346-3-50	220,220,220
	208/230-3-60	358,358,358
	460-3-60	162,162,162
	230-3-50	332,332,332
	380/415-3-50	202,202,202

## APPENDIX B

**Capacity Loading Sequence Example** — The following tables show the loading sequence for a 30HX186 (50/50 split) and a 30HX161 (59/41 split) chiller. Each

compressor has 2 loaders. There is no difference in operation between “Staged” and “Equal” circuit loading on 2 compressor chillers.

**STANDARD LOADING SEQUENCE (CIRCUIT A LEAD CIRCUIT, 2-COMPRESSOR UNIT)**

STAGE	COMP A1	LOADER A1	LOADER A2	COMP B1	LOADER B1	LOADER B2	% TOTAL CAPACITY (50/50 Split)	% TOTAL CAPACITY (59/41 Split)
0	0	0	0	0	0	0	0.0	0.0
1	1	0	0	0	0	0	20.0	23.5
2	1	1	0	0	0	0	35.0	41.1
3	1	1	1	0	0	0	50.0	58.8
4	1	1	0	1	1	0	70.0	70.0
5	1	1	0	1	1	1	85.0	82.4
6	1	1	1	1	1	1	100.0	100.0

**CLOSE CONTROL LOADING SEQUENCE (CIRCUIT A LEAD CIRCUIT, 2-COMPRESSOR UNIT)**

STAGE	COMP A1	LOADER A1	LOADER A2	COMP B1	LOADER B1	LOADER B2	% TOTAL CAPACITY (50/50 Split)	% TOTAL CAPACITY (59/41 Split)
0	0	0	0	0	0	0	0.0	0.0
1	1	0	0	0	0	0	20.0	23.5
2	1	1	0	0	0	0	35.0	41.1
3	1	1	1	0	0	0	50.0	58.8
3A	1	0	0	1	0	0	40.0	40.0
3B	1	0	0	1	1	0	55.0	52.4
4	1	0	0	1	1	1	70.0	64.7
5	1	1	0	1	1	1	85.0	82.4
6	1	1	1	1	1	1	100.0	100.0

**LEGEND**

- 0 — Off
- 1 — On

**NOTES:**

1. Stage 3A (and 3B for 59/41 split) is not used by the algorithm when increasing stages. Stage 3 (and 2 for 59/41 split) is not used when decreasing stages.
2. The % Total Capacities above are calculated based on compressor nominal tons. For the case of the 59/41 split above, the 30HX uses compressors with flow rates of 250 and 174 cfm (from compressor model numbers 06N\_1250 and 06N\_1174), which represent nominal tons of 80 and 56 (respectively) at 60 Hz. A factor of 40% is used when no loaders are energized and a factor of 70% is used when Loader 1 is energized. The capacity shown for Stage 3B above is calculated as follows:

$$\begin{aligned} \text{\% Total Capacity} &= [(0.40 \times 80 + 0.70 \times 56)/(80 + 56)] \times 100\% \\ &= 52.4\% \end{aligned}$$

**Nominal Tons**

COMPRESSOR PART NO.	60 Hz NOM. TONS	50 Hz NOM. TONS
06N_1123	39	—
06N_1146	46	39
06N_1174	56	46
06N_1209	66	56
06N_1250	80	66
06N_1300	—	80

**APPENDIX B (cont)**

The following tables show the loading sequence for 30HX206 (57/43 split) and 30HX271 (67/33 split) chillers. All

compressors have two loaders and the chillers are configured for *equal circuit loading*. See Note 2.

STANDARD LOADING SEQUENCE (CIRCUIT A LEAD CIRCUIT, 3-COMPRESSOR UNIT)									
STAGE	COMP A1	LOADER A1	LOADER A2	COMP A2	COMP B1	LOADER B1	LOADER B2	% TOTAL CAPACITY (57/43 Split)	% TOTAL CAPACITY (67/33 Split)
0	0	0	0	0	0	0	0	0.0	0.0
1	1	0	0	0	0	0	0	14.3	13.3
2	1	1	0	0	0	0	0	25.0	23.3
3	1	1	1	0	0	0	0	35.7	33.3
4	1	1	0	0	1	1	0	55.2	46.7
5	1	1	0	0	1	1	1	68.2	56.7
6	1	1	1	0	1	1	1	78.9	66.7
7	1	1	0	1	1	1	1	83.0	80.0
8	1	1	1	1	1	1	1	100.0	100.0

CLOSE CONTROL LOADING SEQUENCE (CIRCUIT A LEAD CIRCUIT, 3-COMPRESSOR UNIT)									
STAGE	COMP A1	LOADER A1	LOADER A2	COMP A2	COMP B1	LOADER B1	LOADER B2	% TOTAL CAPACITY (57/43 Split)	% TOTAL CAPACITY (67/33 Split)
0	0	0	0	0	0	0	0	0.0	0.0
1	1	0	0	0	0	0	0	14.3	13.3
2	1	1	0	0	0	0	0	25.0	23.3
3	1	1	1	0	0	0	0	35.7	33.3
3A	1	0	0	0	1	0	0	31.6	26.7
4	1	0	0	0	1	1	0	44.5	36.7
5	1	0	0	0	1	1	1	57.5	46.7
6	1	1	0	0	1	1	1	68.2	56.7
7	1	1	1	0	1	1	1	78.9	66.7
7A	1	0	0	1	1	1	1	65.9	60.0
8	1	1	0	1	1	1	1	83.0	80.0
9	1	1	1	1	1	1	1	100.0	100.0

LEGEND

0 — Off  
1 — On

NOTES:

1. Stages 3A and 7A are not used by the algorithm when increasing stages. Stages 3 and 7 are not used by the algorithm when decreasing stages.
2. The loading sequence for 30GX205-265 units is the same as those shown for the 30HZ206,271 above.

## APPENDIX B (cont)

The following tables show the loading sequence for 30HX206 (57/43 split) and 30HX271 (67/33 split) chillers. All compressors have two loaders and the chiller is configured for

*staged circuit loading*. Loaders A1 on compressors A1 and A2 are energized in parallel. The same is true for Loaders A2 on both compressors A1 and A2. See Note 3.

STANDARD LOADING SEQUENCE (CIRCUIT A LEAD CIRCUIT, 3-COMPRESSOR UNIT)									
STAGE	COMP A1	LOADER A1	LOADER A2	COMP A2	COMP B1	LOADER B1	LOADER B2	% TOTAL CAPACITY (57/43 Split)	% TOTAL CAPACITY (67/33 Split)
0	0	0	0	0	0	0	0	0.0	0.0
1	1	0	0	0	0	0	0	14.3	13.3
2	1	1	0	0	0	0	0	25.0	23.3
3	1	1	1	0	0	0	0	35.7	33.3
4	1	1	0	1	0	0	0	39.7	46.7
5	1	1	1	1	0	0	0	56.8	66.7
6	1	1	1	1	1	1	0	87.0	90.0
7	1	1	1	1	1	1	1	100.0	100.0

CLOSE CONTROL LOADING SEQUENCE (CIRCUIT A LEAD CIRCUIT, 3-COMPRESSOR UNIT)									
STAGE	COMP A1	LOADER A1	LOADER A2	COMP A2	COMP B1	LOADER B1	LOADER B2	% TOTAL CAPACITY (57/43 Split)	% TOTAL CAPACITY (67/33 Split)
0	0	0	0	0	0	0	0	0.0	0.0
1	1	0	0	0	0	0	0	14.3	13.3
2	1	1	0	0	0	0	0	25.0	23.3
3	1	1	1	0	0	0	0	35.7	33.3
3A	1	0	0	1	0	0	0	22.7	26.7
4	1	1	0	1	0	0	0	39.7	46.7
5	1	1	1	1	0	0	0	56.8	66.7
6	1	1	1	1	1	0	0	74.1	80.0
7	1	1	1	1	1	1	0	87.0	90.0
8	1	1	1	1	1	1	1	100.0	100.0

**LEGEND**

- 0 — Off
- 1 — On

**NOTES:**

1. Stage 3A is not used by the algorithm when increasing stages. Stage 3 is not used by the algorithm when decreasing stages.
2. The % Total Capacities above are calculated based on compressor nominal tons. For the case of the 57/43 split above, the 30HX uses compressors with flow rates of 209, 123 and 250 cfm (from compressor model numbers 06N\_1209, 06N\_123 and 06N\_1250),

which represent nominal tons of 66, 39 and 80 (respectively) at 60 Hz. A factor of 40% is used when no loaders are energized and a factor of 70% is used when Loader 1 is energized. The capacity shown for Stage 4 above is calculated as follows:

$$\% \text{ Total Capacity} = [0.70 \times 66 + 0.70 \times 39 + 0.0 \times 80] / (66 + 39 + 80) \times 100\% = 39.7\%$$

3. The loading sequence for 30GX205-265 units is the same as those shown for the 30HX206,271 above.

## APPENDIX C

The following are the available accessories for 30GX/HXA/HXC units.

ACCESSORY PART NUMBER	USED ON	DESCRIPTION OF ACCESSORY	COMMENTS
30GX-900-001	30GX080-105	Condenser Grille Package	
30GX-900-002	30GX106-125	Condenser Grille Package	
30GX-900-003	30GX136, 150, 160	Condenser Grille Package	
30GX-900-013	30GX151, 161, 175, 205, 225	Condenser Grille Package	
30GX-900-024	30GX176	Condenser Grille Package	
30GX-900-009	30GX206, 226, 250	Condenser Grille Package	
30GX-900-010	30GX251, 265	Condenser Grille Package	
30GX-900-004	30GX (115 V Control)	Minimum Load Valve	both circuits
30GX-900-005	30GX (230 V Control)	Minimum Load Valve	both circuits
30GX-900-006	30GX (460 V)	Control Transformer	
30GX-900-007	30GX (575 V)	Control Transformer	
30GX-900-008	30GX (208 V)	Control Transformer	
30GX-900-012	30GX080-150, 160	3-Phase Motormaster® Control	single controller
30GX-900-014	30GX151, 161-265	3-Phase Motormaster Control	two controllers
30GX-900-015	30GX080-265	Sound Enclosure/Hail Guard/Wind Baffle	header end only
30GX-900-016	30GX080-105	Sound Enclosure/Hail Guard/Wind Baffle	one side per package
30GX-900-017	30GX106-125	Sound Enclosure/Hail Guard/Wind Baffle	one side per package
30GX-900-018	30GX136, 150, 160	Sound Enclosure/Hail Guard/Wind Baffle	one side per package
30GX-900-019	30GX151, 161, 175, 205, 225	Sound Enclosure/Hail Guard/Wind Baffle	one side per package (151, 161, 175) cooler side only (205, 225)
30GX-900-020	30GX176, 206, 226, 250	Sound Enclosure/Hail Guard/Wind Baffle	one side per package (176) cooler side only (206, 226, 250)
30GX-900-028	30GX205, 225	Sound Enclosure/Hail Guard/Wind Baffle	control box side only
30GX-900-029	30GX206, 226, 250	Sound Enclosure/Hail Guard/Wind Baffle	control box side only
30GX-900-030	30GX251, 265	Sound Enclosure/Hail Guard/Wind Baffle	cooler side only
30GX-900-031	30GX251, 265	Sound Enclosure/Hail Guard/Wind Baffle	control box side only
30GX-900-021	30GX (230 V Control)	Cooler Heater	
30GX-900-022	30GX (115 V Control)	Cooler Heater	
30GX-900-023	30GX080-265	Vibration Isolation Pads	
30GX-900-025	30GX105-136, 160-176	Insulation Kit (16", 3 Pass Cooler with Economizer)	tubesheets/heads/economizer
30GX-900-026	30GX150, 151	Insulation Kit (14", 2 Pass Cooler with Economizer)	tubesheets/heads/economizer
30GX-900-027	30GX150, 151	Insulation Kit (14", 1 Pass Cooler with Economizer)	tubesheets/heads/economizer
30HX-900-001	30HX116-271	Sound Enclosure Panels	
30HX-900-011	30HX076-106	Sound Enclosure Panels	
30HX-900-002	30GX080-090, 150, 151 30HX076-096, 116-146	Victaulic Cooler Connections (14 in.)	
30HX-900-003	30GX105-136, 160-176 30HX106, 161-186	Victaulic Cooler Connections (16 in.)	
30HX-900-014	30GX205-265 30HX206-271	Victaulic Cooler Connections (18 in.)	
30HX-900-015	30HX206-271	Victaulic Condenser Connection (22 in.)	
30HX-900-004	30HX076-146	Victaulic Condenser (18 in.)	
30HX-900-005	30HX161-186	Victaulic Condenser (20 in.)	
30HX-900-006	30HX (230, 460 V)	Control Transformer	
30HX-900-013	30HX (575 V)	Control Transformer	
30HX-900-007	30GX,HX all	LID 2B Enhanced Remote Controller	
30HX-900-008	30HX (115 V Control)	Minimum Load Valve	single circuit
30HX-900-009	30HX (230 V Control)	Minimum Load Valve	single circuit
30HX-900-010	30HX076-271	Vibration Isolation Pad	
30HX-900-016	30GX080,090 30HX076-096	Insulation Kit (14", 3 Pass Cooler no Economizer)	tubesheets/heads
30HX-900-017	30GX080,090 30HX076-096	Insulation Kit (14", 2 Pass Cooler no Economizer)	tubesheets/heads
30HX-900-020	30GX105-136,160-176 30HX161-186	Insulation Kit (16", 2 Pass Cooler with Economizer)	tubesheets/heads/economizer
30HX-900-021	30GX160-176 30HX161-186	Insulation Kit (16", 1 Pass Cooler with Economizer)	tubesheets/heads/economizer
30HX-900-022	30GX205-265 30GX206-271	Insulation Kit (18", 2 Pass Cooler with Economizer)	tubesheets/heads/economizer
30HX-900-023	30GX205-265 30HX206-271	Insulation Kit (18", 1 Pass Cooler with Economizer)	tubesheets/heads/economizer



**APPENDIX D**

**Compressor Protection Module Configuration Header Punch-Outs and Overload Settings**

**2-Compressor Units**

<b>UNIT MODEL NUMBER</b>	<b>PUNCH OUTS FOR CPM-A</b>	<b>PUNCH OUTS FOR CPM-B</b>	<b>COMP A1 OVERLOAD SETTING</b>	<b>COMP B1 OVERLOAD SETTING</b>
30GX-080---1	1,2,3,6,7,8	1,2,3,5,6,7,8	85	71
30GX-080---2	1,2,5,6,7	1,2,4,5,7	128	107
30GX-080---5	1,4,8	1,3,6,7,8	234	195
30GX-080---6	1,2,4,5,7,8	1,2,3,6,8	106	88
30GX-080---8	1,4,5	1,3,5,6,7	223	183
30GX-080---9	1,2,5,7	1,2,4,5	135	111
30GX-090---1	1,2,4,5,6	1,2,3,5,6,7,8	103	71
30GX-090---2	1,3,4,5,6,7	1,2,4,5,7	156	107
30GX-090---5	2,3,4,6	1,3,5,7,8	285	195
30GX-090---6	1,2,5,6,7	1,2,3,6,8	129	88
30GX-090---8	2,3,4,5,6,8	1,3,5,6,7	269	183
30GX-090---9	1,3,4,5,7	1,2,4,5	163	111
30GX-105---8	2,3,5,6	1,3,8	299	207
30GX-105---9	1,3,4	1,2,4	181	125
30GX-106---1	1,2,4,6,8	1,2,3,5,7	116	80
30GX-106---2	1,3,4,7,8	1,2,4,7	175	120
30GX-106---5	2,3	1,4,5,8	320	220
30GX-106---6	1,2,6	1,2,4,5,6,7,8	145	100
30GX-106---8	2,3,5,6	1,3,8	299	207
30GX-106---9	1,3,4	1,2,4	181	125
30GX-115---1	1,2,6,7,8	1,2,3,5,7	141	80
30GX-115---2	1,4,5,6,8	1,2,4,7	213	120
30GX-115---5	3,4,5	1,4,5,8	390	220
30GX-115---6	1,3,4,7	1,2,4,5,6,7,8	176	100
30GX-115---8	2,6,7,8	1,3,8	363	207
30GX-115---9	1,4,5,8	1,2,4	220	125
30GX-125---1	1,2,6,7,8	1,2,3,8	141	96
30GX-125---2	1,4,5,6,8	1,2,6	213	145
30GX-125---5	3,4,5	2,3,4,5,6,7,8	390	265
30GX-125---6	1,3,4,7	1,2,4,7,8	176	120
30GX-125---8	2,6,7,8	1,5	363	250
30GX-125---9	1,4,5,8	1,2,8	220	151
30GX-136---1	1,2,6,7,8	1,2,4,6,8	141	116
30GX-136---2	1,4,5,6,8	1,3,4,7,8	213	175
30GX-136---5	3,4,5	2,3	390	320
30GX-136---6	1,3,4,7	1,2,6	176	145
30GX-136---8	2,6,7,8	2,3,5,6	363	299
30GX-136---9	1,4,5,8	1,3,4	220	181
30GX-150---8	2,3,5,6	4,6	299	451
30GX-150---9	1,3,4	2,3,4,5,7,8	181	273
30GX-151---1	1,3,4,6,8	1,2,4,6,8	172	116
30GX-151---2	1,7	1,3,4,7,8	260	175
30GX-151---5	6,7,8	2,3	475	320
30GX-151---6	1,4,5,6	1,2,6	215	145
30GX-160---8	2,6,7,8	4,6	363	451
30GX-160---9	1,4,5,8	2,3,4,5,7,8	220	273
30GX-161---1	1,3,4,6,8	1,2,6,7,8	172	141
30GX-161---2	1,7	1,4,5,6,8	260	213
30GX-161---5	6,7,8	3,4,5	475	390
30GX-161---6	1,4,5,6	1,3,4,7	215	176
30GX-161---8	4,6	2,6,7,8	451	363
30GX-161---9	2,3,4,5,7,8	1,4,5,8	273	220
30GX-175---8	4,6	4,6	451	451
30GX-175---9	2,3,4,5,7,8	2,3,4,5,7,8	273	273
30GX-176---1	1,3,4,6,8	1,3,4,6,8	172	172
30GX-176---2	1,7	1,7	260	260
30GX-176---5	6,7,8	6,7,8	475	475
30GX-176---6	1,4,5,6	1,4,5,6	215	215
30HXA076---1	1,2,3,5,6,7,8	1,2,3,5,6,7,8	71	71
30HXA076---2	1,2,4,5,7	1,2,4,5,7	107	107
30HXA076---3	1,2,4,7	1,2,4,7	122	122
30HXA076---5	1,3,6,7,8	1,3,6,7,8	195	195
30HXA076---6	1,2,3,6,8	1,2,3,6,8	88	88
30HXA076---8	1,3,5,6,7	1,3,5,6,7	183	183
30HXA076---9	1,2,4,5	1,2,4,5	111	111
30HXA086---1	1,2,3,6,7,8	1,2,3,5,6,7,8	85	71
30HXA086---2	1,2,5,6,7	1,2,4,5,7	128	107
30HXA086---3	1,2,7,8	1,2,4,7	148	122
30HXA086---5	1,4,8	1,3,6,7,8	234	195
30HXA086---6	1,2,4,5,7,8	1,2,3,6,8	106	88
30HXA086---8	1,4,5	1,3,5,6,7	223	183
30HXA086---9	1,2,5,7	1,2,4,5	135	111

**APPENDIX D (cont)**

**Compressor Protection Module Configuration Header Punch-Outs and Overload Settings (cont)**

**2-Compressor Units**

<b>UNIT MODEL NUMBER</b>	<b>PUNCH OUTS FOR CPM-A</b>	<b>PUNCH OUTS FOR CPM-B</b>	<b>COMP A1 OVERLOAD SETTING</b>	<b>COMP B1 OVERLOAD SETTING</b>
30HXA096---1	1,2,4,5,6	1,2,3,5,6,7,8	103	71
30HXA096---2	1,3,4,5,6,7	1,2,4,5,7	156	107
30HXA096---3	1,3,4,8	1,2,4,7	179	122
30HXA096---5	2,3,4,6	1,3,6,7,8	285	195
30HXA096---6	1,2,5,6,7	1,2,3,6,8	129	88
30HXA096---8	2,3,4,5,6,8	1,3,5,6,7	269	183
30HXA096---9	1,3,4,5,7	1,2,4,5	163	111
30HXA106---1	1,2,4	1,2,3,5,6,7,8	125	71
30HXA106---2	1,3,5,7,8	1,2,4,5,7	190	107
30HXA106---3	1,4,5,7,8	1,2,4,7	217	122
30HXA106---5	2,4	1,3,6,7,8	347	195
30HXA106---6	1,3,4,5,6,7	1,2,3,6,8	157	88
30HXA106---8	2,4,5,6	1,3,5,6,7	326	183
30HXA106---9	1,3,6,7	1,2,4,5	198	111
30HXA116---1	1,2,4	1,2,3,6,7,8	125	85
30HXA116---2	1,3,5,7,8	1,2,5,6,7	190	128
30HXA116---3	1,4,5,6,8	1,2,7,8	217	148
30HXA116---5	2,4	1,4,8	347	234
30HXA116---6	1,3,4,5,6,7	1,2,4,5,7,8	157	106
30HXA116---8	2,4,5,6	1,4,5	326	223
30HXA116---9	1,3,6,7	1,2,5,7	198	135
30HXA126---1	1,2,4	1,2,4,5,6	125	103
30HXA126---2	1,3,5,7,8	1,3,4,5,6,7	190	156
30HXA126---3	1,4,5,7,8	1,3,4,8	217	179
30HXA126---5	2,4	2,3,4,6	347	285
30HXA126---6	1,3,4,5,6,7	1,2,5,6,7	157	129
30HXA126---8	2,4,5,6	2,3,4,5,6,8	326	269
30HXA126---9	1,3,6,7	1,3,4,5,7	198	163
30HXA136---1	1,2	1,2,4,5,6	153	103
30HXA136---2	1,4,7,8	1,3,4,5,6,7	231	156
30HXA136---3	2,3,4,5,6,7,8	1,3,4,8	266	179
30HXA136---5	3,6,8	2,3,4,6	423	285
30HXA136---6	1,3,5,7	1,2,5,6,7	191	129
30HXA136---8	3,4,8	2,3,4,5,6,8	401	269
30HXA136---9	1,5,6	1,3,4,5,7	243	163
30HXA146---1	1,2	1,2,4	153	125
30HXA146---2	1,4,7,8	1,3,5,7,8	231	190
30HXA146---3	2,3,4,5,6,7,8	1,4,5,7,8	266	217
30HXA146---5	3,6,8	2,4	423	347
30HXA146---6	1,3,5,7	1,3,4,5,6,7	191	157
30HXA146---8	3,4,8	2,4,5,6	401	326
30HXA146---9	1,5,6	1,3,6,7	243	198
30HXA161---1	1,3,4,6,8	1,2,4,6,8	172	116
30HXA161---2	1,7	1,3,4,7,8	260	175
30HXA161---3	2,3,4,5	1,3,6,7	299	199
30HXA161---5	6,7,8	2,3	475	320
30HXA161---6	1,4,5,6	1,2,6	215	145
30HXA161---8	4,6	2,3,5,6	451	299
30HXA161---9	2,3,4,5,7,8	1,3,4	273	181
30HXA171---1	1,2,6,7,8	1,3,4,6,8	141	172
30HXA171---2	1,4,5,6,8	1,7	213	260
30HXA171---3	1,5,6,8	2,3,5,6	241	299
30HXA171---5	3,4,5	6,7,8	390	475
30HXA171---6	1,3,4,7	1,4,5,6	176	215
30HXA171---8	2,6,7,8	4,6	363	451
30HXA171---9	1,4,5,8	2,3,4,5,7,8	220	273
30HXA186---1	1,3,4,6,8	1,3,4,6,8	172	172
30HXA186---2	1,7	1,7	260	260
30HXA186---3	2,3,5,6	2,3,5,6	299	299
30HXA186---5	6,7,8	6,7,8	475	475
30HXA186---6	1,4,5,6	1,4,5,6	215	215
30HXA186---8	4,6	4,6	451	451
30HXA186---9	2,3,4,5,7,8	2,3,4,5,7,8	273	273
30HXC076---1	1,2,3,4,5,6	1,2,3,4,5,6	50	50
30HXC076---2	1,2,3,5,6,7	1,2,3,5,6,7	73	73
30HXC076---3	1,2,3,5	1,2,3,5	83	83
30HXC076---5	1,2,5,7,8	1,2,5,7,8	133	133
30HXC076---6	1,2,3,4,6,8	1,2,3,4,6,8	60	60
30HXC076---8	1,2,4	1,2,4	125	125
30HXC076---9	1,2,3,5,6	1,2,3,5,6	76	76
30HXC086---1	1,2,3,4,6,7	1,2,3,4,5,6	58	50
30HXC086---2	1,2,3,6,8	1,2,3,5,6,7	88	73
30HXC086---3	1,2,4,5,6,7	1,2,3,5	101	83
30HXC086---5	1,3,4,5,7,8	1,2,5,7,8	161	133
30HXC086---6	1,2,3,5,6,7	1,2,3,4,6,8	73	60
30HXC086---8	1,2	1,2,4	152	125
30HXC086---9	1,2,3,7,8	1,2,3,5,6	92	76

**APPENDIX D (cont)**

**Compressor Protection Module Configuration Header Punch-Outs and Overload Settings (cont)**

**2-Compressor Units**

<b>UNIT MODEL NUMBER</b>	<b>PUNCH OUTS FOR CPM-A</b>	<b>PUNCH OUTS FOR CPM-B</b>	<b>COMP A1 OVERLOAD SETTING</b>	<b>COMP B1 OVERLOAD SETTING</b>
30HXC096--1	1,2,3,5,6,7,8	1,2,3,4,5,6	71	50
30HXC096--2	1,2,4,5,7	1,2,3,5,6,7	108	73
30HXC096--3	1,2,4,7	1,2,3,5	122	83
30HXC096--5	1,3,6,7,8	1,2,5,7,8	197	133
30HXC096--6	1,2,3,6	1,2,3,4,6,8	89	60
30HXC096--8	1,3,5,6,7	1,2,4	183	125
30HXC096--9	1,2,4,5	1,2,3,5,6	111	76
30HXC106--1	1,2,3,6,7	1,2,3,4,5,6	86	50
30HXC106--2	1,2,5,6,8	1,2,3,5,6,7	130	73
30HXC106--3	1,2,6	1,2,3,5	146	83
30HXC106--5	1,5,6,7,8	1,2,5,7,8	238	133
30HXC106--6	1,2,4,5,7	1,2,3,4,6,8	108	60
30HXC106--8	1,4,5,8	1,2,4	220	125
30HXC106--9	1,2,5,7,8	1,2,3,5,6	133	76
30HXC116--1	1,2,3,6,7	1,2,3,4,6,7	86	58
30HXC116--2	1,2,5,6,8	1,2,3,6,8	130	88
30HXC116--3	1,2,6	1,2,4,5,6,7	146	101
30HXC116--5	1,5,6,7,8	1,3,4,5,7,8	238	161
30HXC116--6	1,2,4,5,7	1,2,3,5,6,7	108	73
30HXC116--8	1,4,5,8	1,2	220	152
30HXC116--9	1,2,5,7,8	1,2,3,7,8	133	92
30HXC126--1	1,2,3,6,7	1,2,3,5,6,7,8	86	71
30HXC126--2	1,2,5,6,8	1,2,4,5,7	130	108
30HXC126--3	1,2,6	1,2,4,7	146	122
30HXC126--5	1,5,6,7,8	1,3,6,7,8	238	197
30HXC126--6	1,2,4,5,7	1,2,3,6	108	89
30HXC126--8	1,4,5,8	1,3,5,6,7	220	183
30HXC126--9	1,2,5,7,8	1,2,4,5	133	111
30HXC136--1	1,2,4,5,6	1,2,3,5,6,7,8	103	71
30HXC136--2	1,3,4,5,6,7	1,2,4,5,7	156	108
30HXC136--3	1,3,4,7	1,2,4,7	177	122
30HXC136--5	2,3,4,6	1,3,6,7,8	285	197
30HXC136--6	1,2,5,6,7	1,2,3,6	129	89
30HXC136--8	2,3,4,5,6,7	1,3,5,6,7	267	183
30HXC136--9	1,3,4,5,7,8	1,2,4,5	162	111
30HXC146--1	1,2,4,5,6	1,2,3,6,7	103	86
30HXC146--2	1,3,4,5,6,7	1,2,5,6,8	156	130
30HXC146--3	1,3,4,7	1,2,6	177	146
30HXC146--5	2,3,4,6	1,5,6,7,8	285	238
30HXC146--6	1,2,5,6,7	1,2,4,5,7	129	108
30HXC146--8	2,3,4,5,6,7	1,4,5,8	267	220
30HXC146--9	1,3,4,5,7,8	1,2,5,7,8	162	133
30HXC161--1	1,2,4,6,7,8	1,2,3,5,7,8	112	78
30HXC161--2	1,3,4,6,7	1,2,4,6	170	117
30HXC161--3	1,3,5,7	1,2,5,6	192	132
30HXC161--5	2,3,6,8	1,4,5,6,8	310	214
30HXC161--6	1,2,6,7,8	1,2,3	140	97
30HXC161--8	2,4,5,7	1,3,6,7	289	198
30HXC161--9	1,3,4,7,8	1,2,4,7,8	175	120
30HXC171--1	1,2,3,7	1,2,4,6,7,8	94	112
30HXC171--2	1,2,6,7	1,3,4,6,7	142	170
30HXC171--3	1,3,4,5,6,8	1,3,5,7	158	192
30HXC171--5	1,7,8	2,3,6,8	259	310
30HXC171--6	1,2,4,6	1,2,6,7,8	117	140
30HXC171--8	1,5,6,7,8	2,3,4,7	237	289
30HXC171--9	1,2,6,8	1,3,4,7,8	144	175
30HXC186--1	1,2,4,6,7,8	1,2,4,6,7,8	112	112
30HXC186--2	1,3,4,6,7	1,3,4,6,7	170	170
30HXC186--3	1,3,5,7	1,3,5,7	192	192
30HXC186--5	2,3,6,8	2,3,6,8	310	310
30HXC186--6	1,2,6,7,8	1,2,6,7,8	140	140
30HXC186--8	2,3,4,7	2,3,4,7	289	289
30HXC186--9	1,3,4,7,8	1,3,4,7,8	175	175

**APPENDIX D (cont)**

**Compressor Protection Module Configuration Header Punch-Outs and Overload Settings (cont)**

**3-Compressor Units**

<b>UNIT MODEL NUMBER</b>	<b>PUNCH OUTS FOR CPM-A1</b>	<b>PUNCH OUTS FOR CPM-A2</b>	<b>PUNCH OUTS FOR CPM-B1</b>	<b>COMP A1 OVERLOAD SETTING</b>	<b>COMP A2 OVERLOAD SETTING</b>	<b>COMP B1 OVERLOAD SETTING</b>
30GX205---8	2,6,7,8	1,3,8	4,6	363	207	451
30GX205---9	1,4,5,8	1,2,4	2,3,4,5,7,8	220	125	273
30GX206---1	1,3,4,6,8	1,2,3,5,7	1,2,6,7,8	172	80	141
30GX206---2	1,7	1,2,4,7	1,4,5,6,8	260	120	213
30GX206---5	6,7,8	1,4,5,8	3,4,5	475	220	390
30GX206---6	1,4,5,6	1,2,4,5,6,7,8	1,3,4,7	215	100	176
30GX225---8	4,6	1,5	4,6	451	250	451
30GX225---9	2,3,4,5,7,8	1,2,8	2,3,4,5,7,8	273	151	273
30GX226---1	1,3,4,6,8	1,2,3,8	1,3,4,6,8	172	96	172
30GX226---2	1,7	1,2,6	1,7	260	145	260
30GX226---5	6,7,8	2,3,4,5,6,7,8	6,7,8	475	265	475
30GX226---6	1,4,5,6	1,2,4,7,8	1,4,5,6	215	120	215
30GX226---8	4,6	1,5	4,6	451	250	451
30GX226---9	2,3,4,5,7,8	1,2,8	2,3,4,5,7,8	273	151	273
30GX250---8	4,6	2,6,7,8	4,6	451	363	451
30GX250---9	2,3,4,5,7,8	1,4,5,6	2,3,4,5,7,8	273	220	273
30GX251---1	1,3,4,6,8	1,3,4,6,8	1,2,6,7,8	172	172	141
30GX251---2	1,7	1,7	1,4,5,6,8	260	260	213
30GX251---5	6,7,8	6,7,8	3,4,5	475	475	390
30GX251---6	1,4,5,6	1,4,5,6	1,3,4,7	215	215	176
30GX265---1	1,3,4,6,8	1,3,4,6,8	1,3,4,6,8	172	172	172
30GX265---2	1,7	1,7	1,7	260	260	260
30GX265---5	6,7,8	6,7,8	6,7,8	475	475	475
30GX265---6	1,4,5,6	1,4,5,6	1,4,5,6	215	215	215
30GX265---8	4,6	4,6	4,6	451	451	451
30GX265---9	2,3,4,5,7,8	2,3,4,5,7,8	2,3,4,5,7,8	273	273	273
30HXA206---1	1,2,6,7,8	1,2,3,5,7	1,3,4,6,8	141	80	172
30HXA206---2	1,4,5,6,8	1,2,4,7	1,7	213	120	260
30HXA206---3	1,5,6,8	1,2,5,8	2,3,5,6	241	137	299
30HXA206---5	3,4,5	1,4,5,8	6,7,8	390	220	475
30HXA206---6	1,3,4,7	1,2,4,5,6,7,8	1,4,5,6	176	100	215
30HXA206---8	2,6,7,8	1,3,8	4,6	363	207	451
30HXA206---9	1,4,5,8	1,2,4	2,3,4,5,7,8	220	125	273
30HXA246---1	1,3,4,6,8	1,2,4,6,8	1,3,4,6,8	172	116	172
30HXA246---2	1,7	1,3,4,7,8	1,7	260	175	260
30HXA246---3	2,3,5,6	1,3,6,7	2,3,5,6	299	199	299
30HXA246---5	6,7,8	2,3	6,7,8	475	320	475
30HXA246---6	1,4,5,6	1,2,6	1,4,5,6	215	145	215
30HXA246---8	4,6	2,3,5,6	4,6	451	299	451
30HXA246---9	2,3,4,5,7,8	1,3,4	2,3,4,5,7,8	273	181	273

**APPENDIX D (cont)**

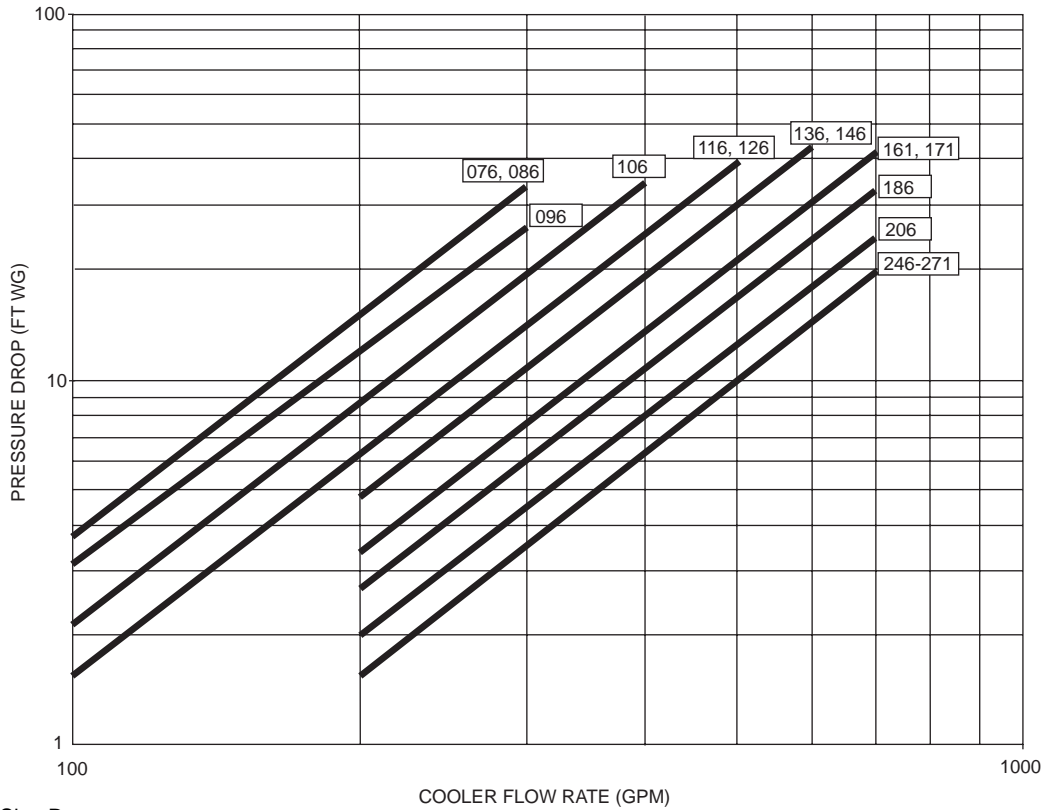
**Compressor Protection Module Configuration Header Punch-Outs and Overload Settings (cont)**

**3-Compressor Units**

<b>UNIT MODEL NUMBER</b>	<b>PUNCH OUTS FOR CPM-A1</b>	<b>PUNCH OUTS FOR CPM-A2</b>	<b>PUNCH OUTS FOR CPM-B1</b>	<b>COMP A1 OVERLOAD SETTING</b>	<b>COMP A2 OVERLOAD SETTING</b>	<b>COMP B1 OVERLOAD SETTING</b>
30HXA261---1	1,3,4,6,8	1,2,6,7,8	1,3,4,6,8	172	141	172
30HXA261---2	1,7	1,4,5,6,8	1,7	260	213	260
30HXA261---3	2,3,5,6	1,5,6,8	2,3,5,6	299	241	299
30HXA261---5	6,7,8	3,4,5	6,7,8	475	390	475
30HXA261---6	1,4,5,6	1,3,4,7	1,4,5,6	215	176	215
30HXA261---8	4,6	2,6,7,8	4,6	451	363	451
30HXA261---9	2,3,4,5,7,8	1,4,5,8	2,3,4,5,7,8	273	220	273
30HXA271---1	1,3,4,6,8	1,3,4,6,8	1,3,4,6,8	172	172	172
30HXA271---2	1,7	1,7	1,7	260	260	260
30HXA271---3	2,3,5,6	2,3,5,6	2,3,5,6	299	299	299
30HXA271---5	6,7,8	6,7,8	6,7,8	475	475	475
30HXA271---6	1,4,5,6	1,4,5,6	1,4,5,6	215	215	215
30HXA271---8	4,6	4,6	4,6	451	451	451
30HXA271---9	2,3,4,5,7,8	2,3,4,5,7,8	2,3,4,5,7,8	273	273	273
30HXC206---1	1,2,3,7	1,2,3,4,5,8	1,2,4,6,7,8	94	53	112
30HXC206---2	1,2,6,7	1,2,3,5,7	1,3,4,6,7	142	80	170
30HXC206---3	1,3,4,5,6,8	1,2,3,6	1,3,5,7	158	90	192
30HXC206---5	1,7,8	1,2,6	2,3,6,8	259	145	310
30HXC206---6	1,2,4,6	1,2,3,4,7	1,2,6,7,8	117	66	140
30HXC206---8	1,5,6,7,8	1,2,5,7	2,3,4,7	237	135	289
30HXC206---9	1,2,6,8	1,2,3,5,8	1,3,4,7,8	144	82	175
30HXC246---1	1,2,4,6,7,8	1,2,3,5,7,8	1,2,4,6,7,8	112	78	112
30HXC246---2	1,3,4,6,7	1,2,4,6	1,3,4,6,7	170	117	170
30HXC246---3	1,3,5,7	1,2,5,6	1,3,5,7	192	132	192
30HXC246---5	2,3,6,8	1,4,5,6,8	2,3,6,8	310	214	310
30HXC246---6	1,2,6,7,8	1,2,3	1,2,6,7,8	140	97	140
30HXC246---8	2,3,4,7	1,3,6,7	2,3,4,7	289	198	289
30HXC246---9	1,3,4,7,8	1,2,4,7,8	1,3,4,7,8	175	120	175
30HXC261---1	1,2,4,6,7,8	1,2,3,7	1,2,4,6,7,8	112	94	112
30HXC261---2	1,3,4,6,7	1,2,6,7	1,3,4,6,7	170	142	170
30HXC261---3	1,3,5,7	1,3,4,5,6,8	1,3,5,7	192	158	192
30HXC261---5	2,3,6,8	1,7,8	2,3,6,8	310	259	310
30HXC261---6	1,2,6,7,8	1,2,4,6	1,2,6,7,8	140	117	140
30HXC261---8	2,3,4,7	1,5,6,7,8	2,3,4,7	289	237	289
30HXC261---9	1,3,4,7,8	1,2,6,8	1,3,4,7,8	175	144	175
30HXC271---1	1,2,4,6,7,8	1,2,4,6,7,8	1,2,4,6,7,8	112	112	112
30HXC271---2	1,3,4,6,7	1,3,4,6,7	1,3,4,6,7	170	170	170
30HXC271---3	1,3,5,7	1,3,5,7	1,3,5,7	192	192	192
30HXC271---5	2,3,6,8	2,3,6,8	2,3,6,8	310	310	310
30HXC271---6	1,2,6,7,8	1,2,6,7,8	1,2,6,7,8	140	140	140
30HXC271---8	2,3,4,7	2,3,4,7	2,3,4,7	289	289	289
30HXC271---9	1,3,4,7,8	1,3,4,7,8	1,3,4,7,8	175	175	175

## APPENDIX E

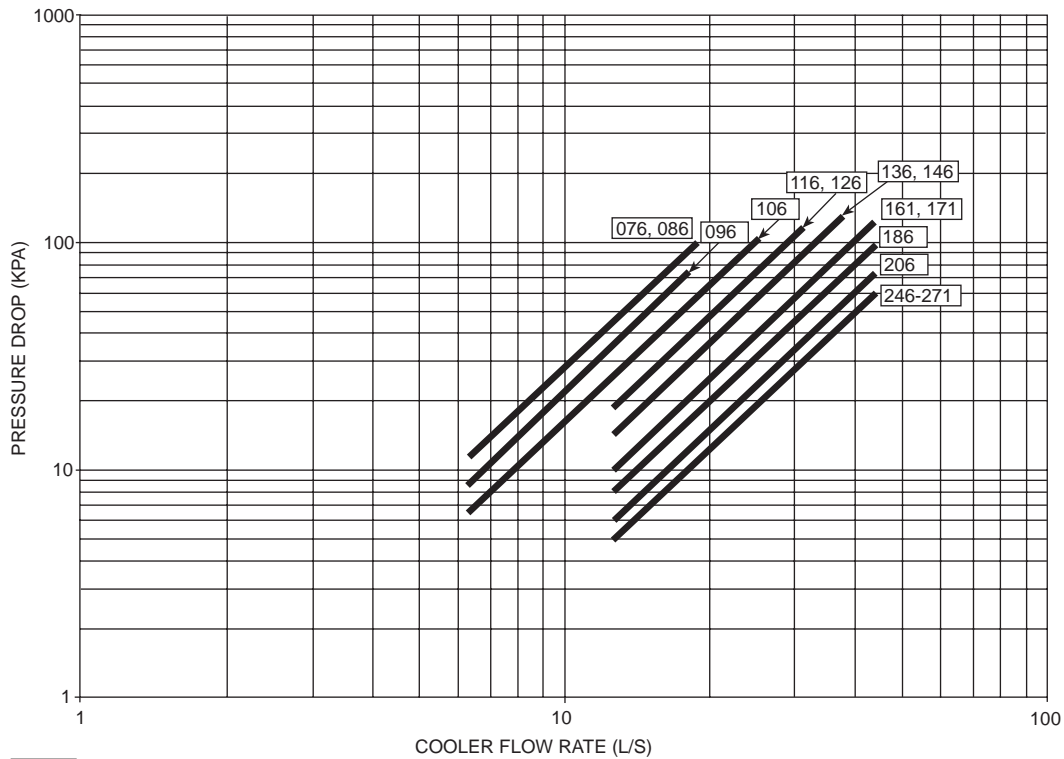
The following charts list pressure drops for coolers and condensers.



Unit Size Range

NOTE: Ft of water = 2.31 x change in psig.

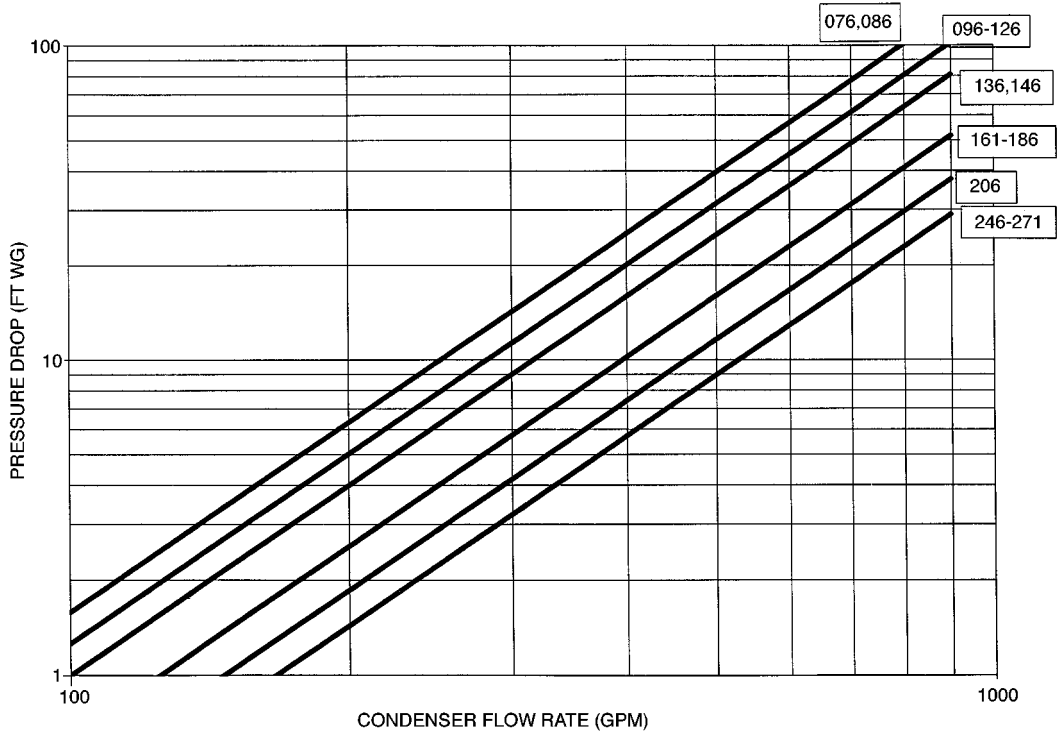
### 30HX COOLER PRESSURE DROP — ENGLISH



Unit Size Range

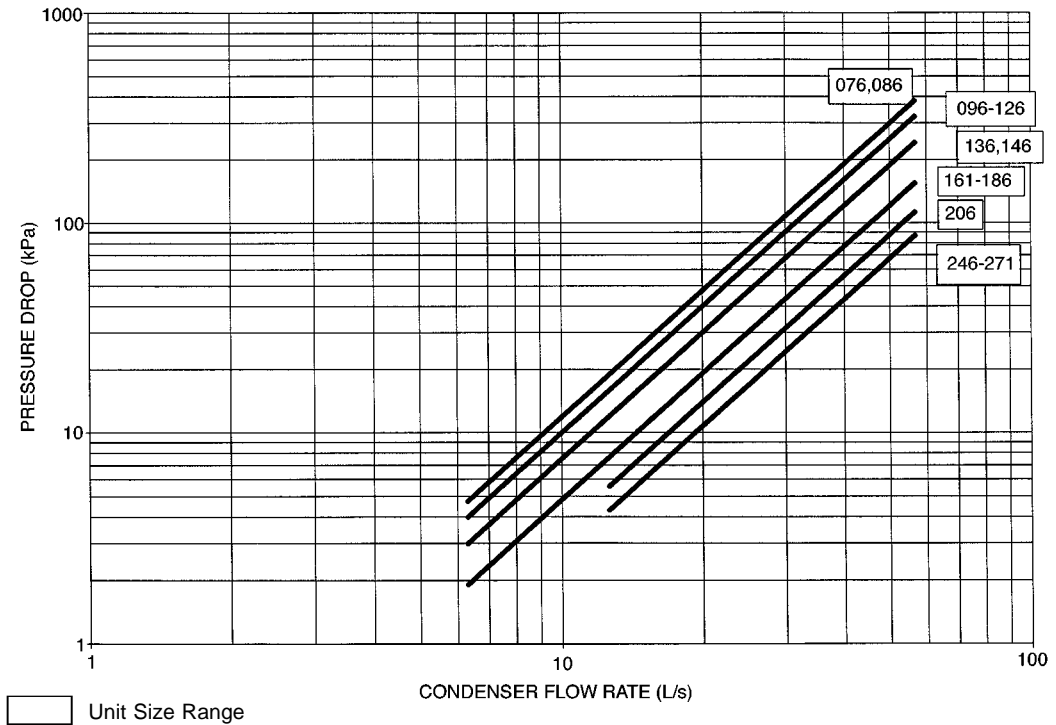
### 30HX COOLER PRESSURE DROP — SI

## APPENDIX E (cont)



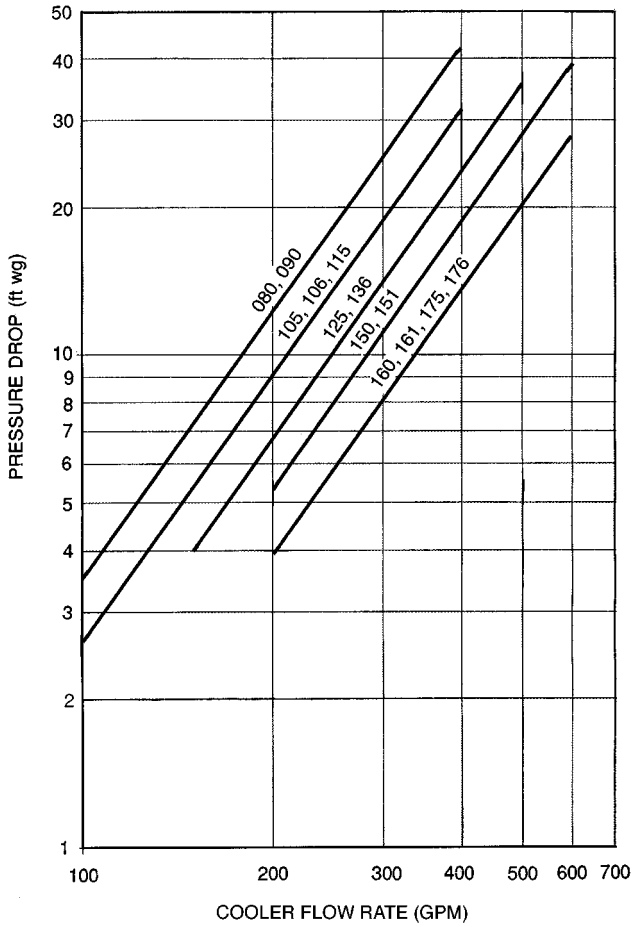
NOTE: Ft of water = 2.31 x change in psig.

### 30HX CONDENSER PRESSURE DROP — ENGLISH



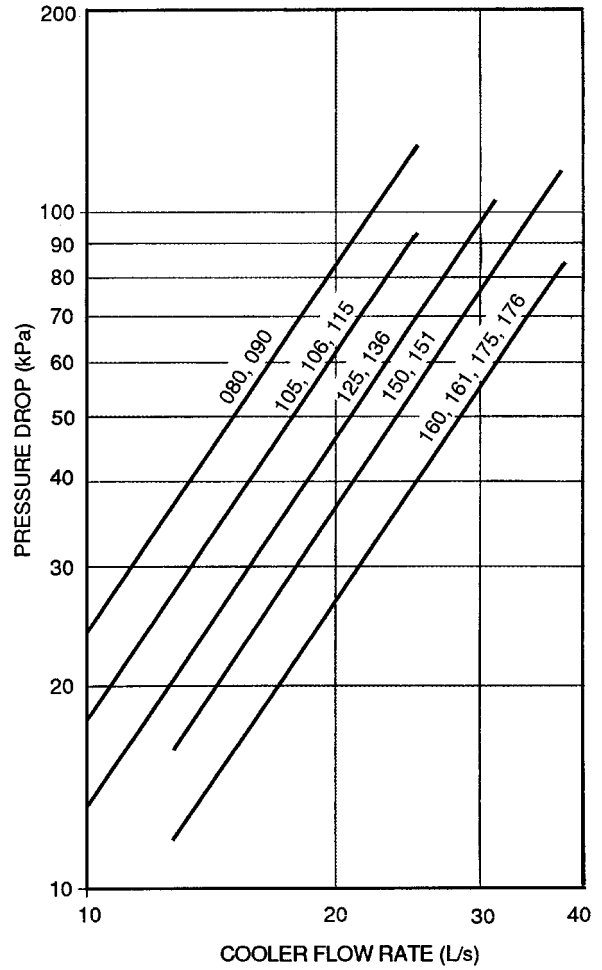
### 30HX CONDENSER PRESSURE DROP — SI

APPENDIX E (cont)

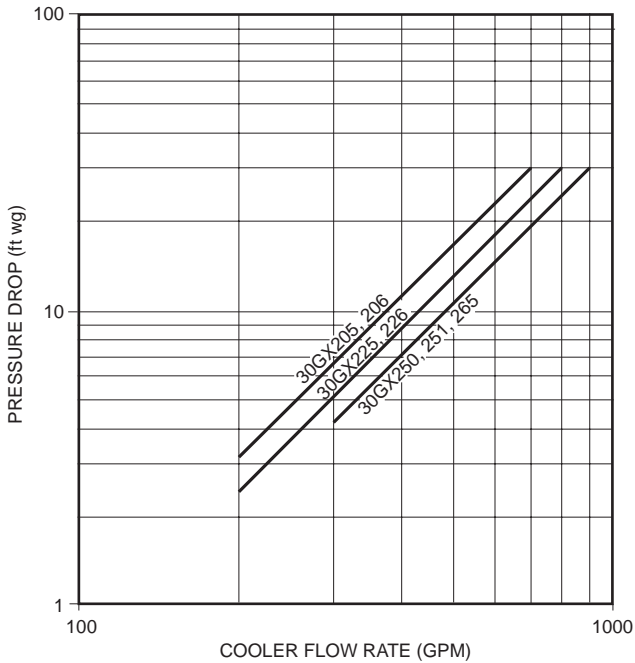


NOTE: Ft of water = 2.31 x change in psig.

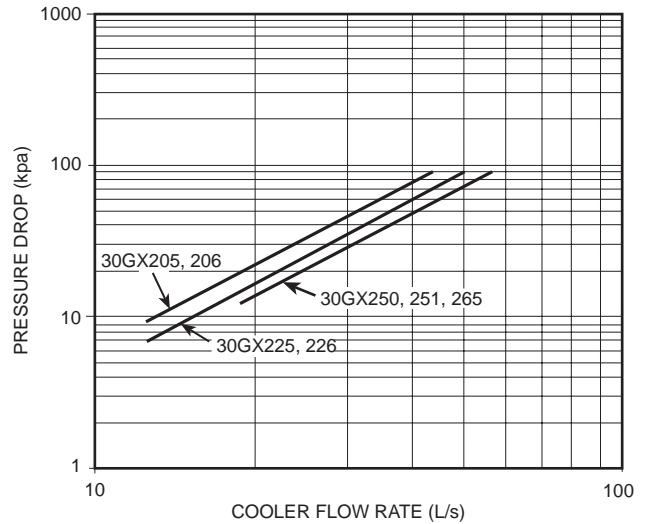
**30GX080-176 COOLER PRESSURE DROP — ENGLISH**



**30GX080-176 COOLER PRESSURE DROP — SI**



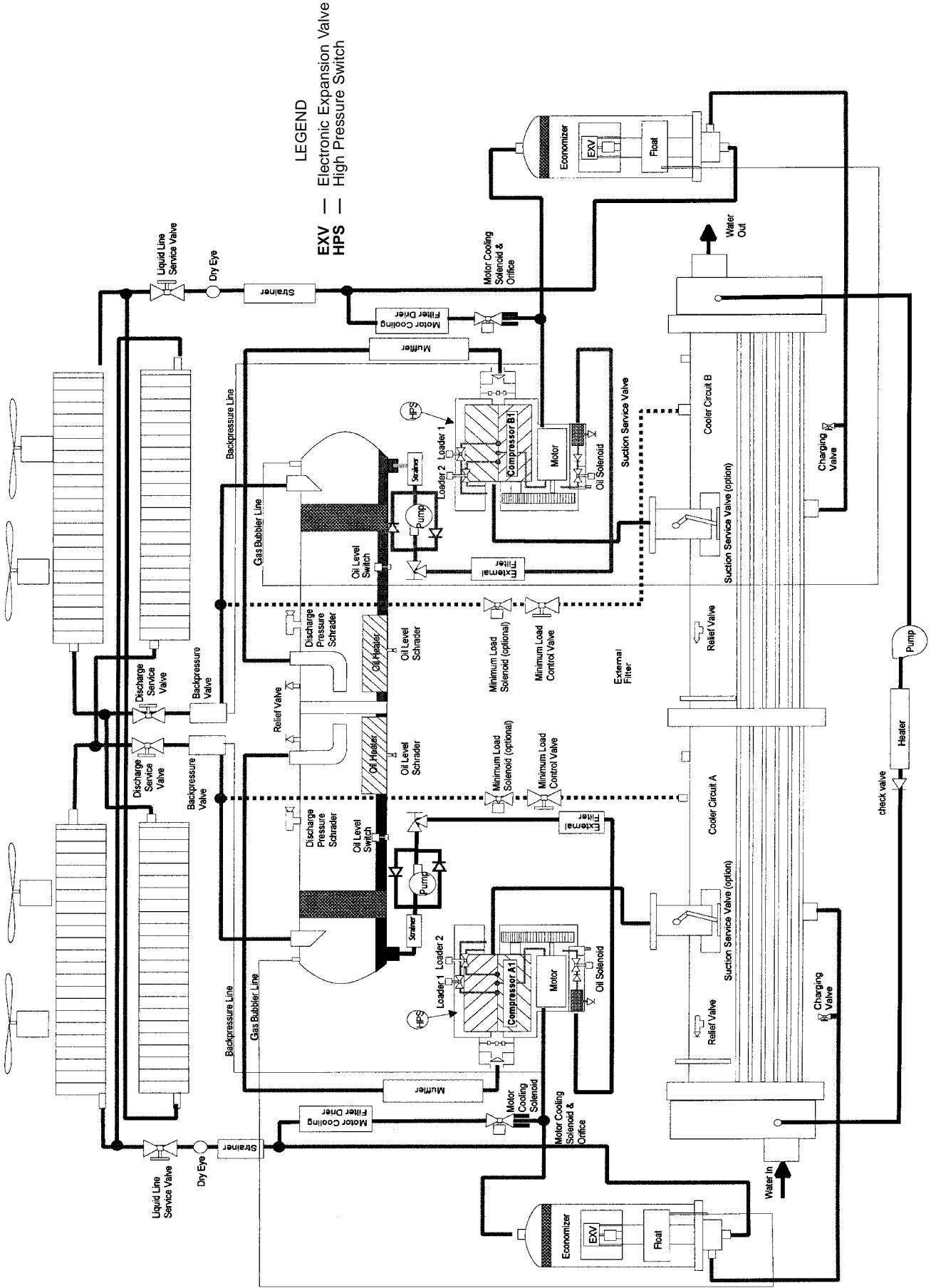
**30GX205-265 COOLER PRESSURE DROP — ENGLISH**



**30GX205-265 COOLER PRESSURE DROP — SI**



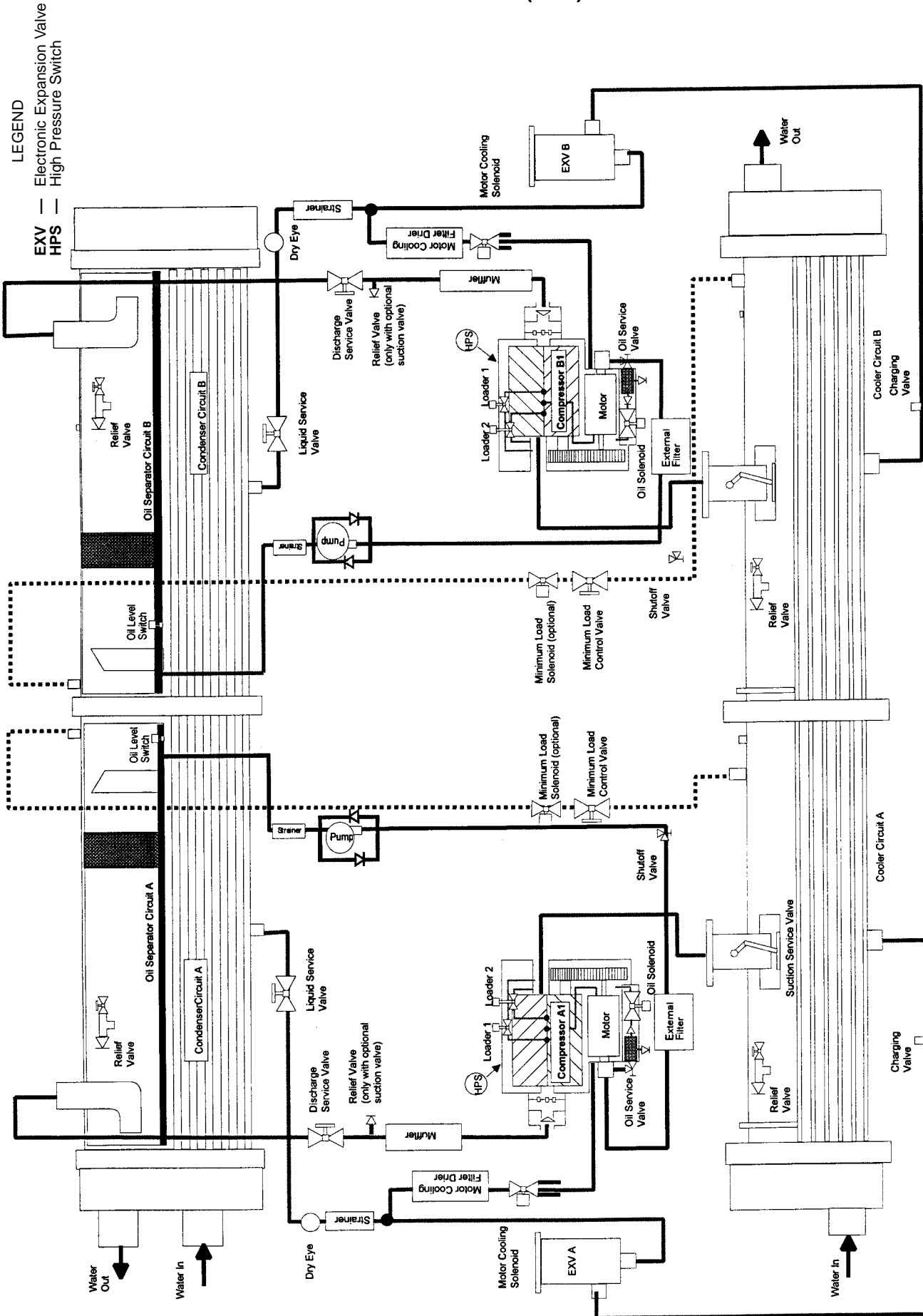
# APPENDIX F



**LEGEND**  
 EXV — Electronic Expansion Valve  
 HPS — High Pressure Switch

Typical System Components, 30GX, With Economizer

APPENDIX F (cont)



LEGEND  
 EXV — Electronic Expansion Valve  
 HPS — High Pressure Switch

Typical System Components, 30HX, Without Economizer

## INDEX

- Accessing Functions and Subfunctions, 13
- Actual Start-Up, 67
- Adjusting PID Routines, 10
- Alarms and Alerts, 43
- Automatic Default Display, 13
- Back Pressure Valve, 4
- Burnout Clean-Up Procedure, 58
- Capacity Control Overrides, 7
- Capacity Control, 6
- Capacity Sequence Determination, 7
- Carrier Comfort Network (CCN) Interface, 64
- Checking Display Codes, 43
- Close Control, 7
- Coil Cleaning, 53
- Complete Unit Stoppage, 43
- Compressor Alarm/Alert Circuit, 43
- Compressor Changeout Sequence, 56
- Compressor Protection Module (CPM), 3, 4
- Compressor Protection, 62
- Condenser Coils (30GX Only), 53
- Condenser Fans (30GX Only), 54
- Condenser Pump Control, 12
- Control (LOR) Switch, 3
- Control Modules, 64
- Cooler and Condenser (30HXC) Pump Control, 10
- Cooler Heater Control, 13
- Cooler Protection, 62
- Cooler Pump Control, 10
- Demand Limit, 39
- Demand Limit, (CCN Loadshed Controlled), 42
- DSIO-HV Relay Module, 3, 64
- Economizer Operation, 4
- Electronic Expansion Device (EXD), 3
- Electronic Expansion Device Module, 3
- EXD Troubleshooting Procedure, 50
- External Temperature Reset, 39
- Externally Powered Demand Limit, 42
- Externally Powered Reset, 39
- EXV Driver Module (DSIO-EXV), 64
- EXV Operation, 3
- Field Wiring, 68
- Filter Drier, 58
- Head Pressure Control, 8
- High Voltage Relay Module (DSIO-HV), 64, 66
- History Function, 25
- Inspecting/Cleaning Heat Exchangers, 53
- Inspecting/Opening Economizers, 51
- Inspecting/Opening Electronic Expansion Valves, 51
- Keypad and Display Module (HSIO-II), 3, 13
- Lead/Lag Determination, 7
- Liquid Line Service Valve, 58
- Loading Sequence, 6
- Major System Components, 3
- Minimum Load Valve, 7
- Minutes Left for Start, 6
- Minutes Off Time, 6
- Moisture-Liquid Indicator, 58
- Motor Cooling, 4
- Oil Charging/Low Oil Recharging, 55
- Oil Filter Maintenance, 56
- Oil Pumps, 4
- Oil Separator Heaters (30GX), 62
- Operating Sequence, 67
- Operation Data, 3
- Power Failure External to the Unit, 43
- Pre-Start-Up Procedure, 67
- Pressure Relief Valves, 62
- Pressure Transducer Calibration, 59
- Pressure Transducers, 59
- Processor Module (PSIO-1), 3, 64, 66
- PSIO-2 (8052) Module, 3, 64
- Refrigerant Charging/Adding Charge, 54
- Relief Devices, 62
- Replacing Defective Processor Module, 66
- Replacing the External Oil Filter, 56
- Replacing the Internal Oil Filter, 56
- Restart Procedure, 43
- Retubing, 52
- Return Fluid Temperature Reset, 39
- Safety Considerations, 1
- Safety Devices, 62
- Schedule Function, 37
- Sensors, 4
- Service Function, 30
- Service, 52
- Servicing Coolers and Condensers, 52
- Set Point Function, 25
- Single Circuit Stoppage, 43
- Start-Up and Operation, 67
- Start-Up Checklist, CL-1
- Status Function, 16
- System Check, 67
- Temperature Reset, 39
- Test Function, 25
- Thermistor Replacement, 58
- Thermistors, 58
- Tightening Cooler/Condenser Head Bolts, 52
- Troubleshooting, 43
- Tube Plugging, 52
- Unit Shutoff, 43
- Water Treatment, 53
- Winter Shutdown Preparation, 66
- Wye-Delta vs. Across-the-Line (XL) Starting Option, 5

## SERVICE TRAINING

**Packaged Service Training** programs are an excellent way to increase your knowledge of the equipment discussed in this manual, including:

- Unit Familiarization
- Installation Overview
- Maintenance
- Operating Sequence

A large selection of product, theory, and skills programs are available, using popular video-based formats and materials. All include video and/or slides, plus companion book.

**Classroom Service Training** which includes “hands-on” experience with the products in our labs that can mean increased confidence that really pays dividends in faster troubleshooting and fewer callbacks. Course descriptions and schedules are in our catalog.

**CALL FOR FREE CATALOG 1-800-962-9212**

Packaged Service Training       Classroom Service Training

**START-UP CHECKLIST FOR 30GX,HX LIQUID CHILLERS**  
(Remove and use for job file.)

**A. Preliminary Information**

JOB NAME \_\_\_\_\_

LOCATION \_\_\_\_\_

INSTALLING CONTRACTOR \_\_\_\_\_

DISTRIBUTOR \_\_\_\_\_

START-UP PERFORMED BY \_\_\_\_\_

**EQUIPMENT:**

MODEL \_\_\_\_\_

S/N \_\_\_\_\_

**COMPRESSORS:**

CIRCUIT A

CIRCUIT B

1) MODEL # \_\_\_\_\_

1) MODEL # \_\_\_\_\_

S/N \_\_\_\_\_

S/N \_\_\_\_\_

2) MODEL # \_\_\_\_\_

2) MODEL # \_\_\_\_\_

S/N \_\_\_\_\_

S/N \_\_\_\_\_

**COOLER:**

MODEL # \_\_\_\_\_

S/N \_\_\_\_\_

**CONDENSER: (30HX ONLY)**

MODEL # \_\_\_\_\_

S/N \_\_\_\_\_

**AIR-HANDLING EQUIPMENT:**

MANUFACTURER \_\_\_\_\_

MODEL # \_\_\_\_\_

S/N \_\_\_\_\_

ADDITIONAL AIR-HANDLING UNITS AND ACCESSORIES \_\_\_\_\_

\_\_\_\_\_  
\_\_\_\_\_  
\_\_\_\_\_  
\_\_\_\_\_

## B. Preliminary Equipment Check

IS THERE ANY SHIPPING DAMAGE? \_\_\_\_\_ IF SO, WHERE \_\_\_\_\_

---

WILL THIS DAMAGE PREVENT UNIT START-UP? \_\_\_\_\_

- UNIT IS LEVEL IN ITS INSTALLATION
- UNIT IS SUPPLIED WITH THE PROPER CONTROL VOLTAGE \_\_\_\_\_ VAC
- ELECTRICAL CIRCUIT WIRING HAS BEEN SIZED AND INSTALLED PROPERLY
- UNIT GROUND WIRE HAS BEEN CONNECTED
- ELECTRICAL CIRCUIT PROTECTION HAS BEEN SIZED AND INSTALLED PROPERLY
- ALL TERMINALS ARE TIGHT
- ALL CABLES AND THERMISTORS HAVE BEEN INSPECTED FOR CROSSED WIRES
- ALL PLUG ASSEMBLIES ARE TIGHT

### CHECK AIR-HANDLING SYSTEM

- ALL AIR HANDLERS ARE OPERATING
- ALL CHILLED WATER VALVES ARE OPEN
- ALL FLUID PIPING IS CONNECTED PROPERLY
- ALL AIR HAS BEEN VENTED FROM THE SYSTEM
- CHILLED WATER PUMP (CWP) IS OPERATING WITH THE CORRECT ROTATION

CWP AMPERAGE:            RATED: \_\_\_\_\_            ACTUAL: \_\_\_\_\_

PUMP PRESSURES:            INLET: \_\_\_\_\_            OUTLET: \_\_\_\_\_

### CHECK CONDENSER SYSTEM (30HX ONLY):

- ALL CONDENSER WATER VALVES ARE OPEN
- ALL CONDENSER PIPING IS CONNECTED PROPERLY

ALL AIR HAS BEEN VENTED FROM THE SYSTEM

- CONDENSER WATER PUMP IS OPERATING WITH THE CORRECT ROTATION

CONDENSER WATER PUMP AMP:    RATED: \_\_\_\_\_    ACTUAL: \_\_\_\_\_

PUMP PRESSURES:            INLET: \_\_\_\_\_            OUTLET: \_\_\_\_\_

### CHECK REMOTE CONDENSER SYSTEM (30HXA ONLY):

- ALL CONDENSER PIPING IS CONNECTED PROPERLY
- CONDENSER LINES/CONDENSER HAS BEEN EVACUATED, AS REQUIRED

**C. Unit Start-Up**

- CWP STARTER HAS BEEN PROPERLY INTERLOCKED WITH THE CHILLER
- ALL LIQUID VALVES ARE BACKSEATED
- ALL DISCHARGE VALVES ARE OPEN
- ALL SUCTION VALVES ARE OPEN, IF EQUIPPED
- ALL OIL LINE VALVES ARE OPEN
- UNIT HAS BEEN LEAK CHECKED

LOCATE, REPAIR, AND REPORT ANY REFRIGERANT LEAKS \_\_\_\_\_  
 \_\_\_\_\_  
 \_\_\_\_\_  
 \_\_\_\_\_

- CHECK VOLTAGE IMBALANCE: AB \_\_\_\_\_ AC \_\_\_\_\_ BC \_\_\_\_\_  
 AVERAGE VOLTAGE = \_\_\_\_\_ (SEE INSTALLATION INSTRUCTIONS)  
 MAXIMUM DEVIATION = \_\_\_\_\_ (SEE INSTALLATION INSTRUCTIONS)  
 VOLTAGE IMBALANCE = \_\_\_\_\_ (SEE INSTALLATION INSTRUCTIONS)
- VOLTAGE IMBALANCE IS LESS THAN 2%

DO NOT START CHILLER IF VOLTAGE IMBALANCE IS GREATER THAN 2%. CONTACT LOCAL POWER COMPANY FOR ASSISTANCE.

- ALL INCOMING POWER VOLTAGE IS WITHIN RATED VOLTAGE RANGE

**CHECK COMPRESSOR RUNNING CURRENT:**

COMPRESSOR	NO LOADERS	ONE LOADER	FULL LOAD
COMP A1,L1	_____ AMPS	_____ AMPS	_____ AMPS
COMP A1,L2	_____ AMPS	_____ AMPS	_____ AMPS
COMP A1,L3	_____ AMPS	_____ AMPS	_____ AMPS
COMP B1,L1	_____ AMPS	_____ AMPS	_____ AMPS
COMP B1,L2	_____ AMPS	_____ AMPS	_____ AMPS
COMP B1,L3	_____ AMPS	_____ AMPS	_____ AMPS
COMP A2,L1	_____ AMPS	_____ AMPS	_____ AMPS
COMP A2,L2	_____ AMPS	_____ AMPS	_____ AMPS
COMP A2,L3	_____ AMPS	_____ AMPS	_____ AMPS

**CHECK COOLER WATER LOOP:**

WATER LOOP DESIGN VOLUME: \_\_\_\_\_ GALLONS (LITERS)

CALCULATED VOLUME \_\_\_\_\_ GALLONS (LITERS)

3 GALLONS/NOMINAL TON (3.32 LITERS/kW) FOR AIR CONDITIONING

6 GALLONS/NOMINAL TON (6.65 LITERS/kW) FOR PROCESS COOLING

- PROPER LOOP VOLUME ESTABLISHED
- PROPER LOOP CORROSION INHIBITOR INCLUDED \_\_\_\_\_ GALLONS (LITERS) OF \_\_\_\_\_
- PROPER LOOP FREEZE PROTECTION INCLUDED, IF REQUIRED  
 \_\_\_\_\_GALLONS (LITERS) OF \_\_\_\_\_
- PIPING INCLUDES ELECTRIC HEATER TAPE, IF EXPOSED TO THE OUTSIDE
- INLET PIPING TO COOLER INCLUDES A 40 MESH STRAINER

**CHECK PRESSURE DROP ACROSS THE COOLER:**

ENTERING COOLER: \_\_\_\_\_ PSIG (kPa)

LEAVING COOLER: \_\_\_\_\_ PSIG (kPa)

(LEAVING – ENTERING) × 2.31 FT OF H<sub>2</sub>O/PSIG = \_\_\_\_\_ FT OF H<sub>2</sub>O

(LEAVING – ENTERING) × 0.334 M OF H<sub>2</sub>O/kPa = \_\_\_\_\_ M OF H<sub>2</sub>O

PLOT COOLER PRESSURE DROP ON PERFORMANCE DATA CHART (IN PRODUCT DATA LITERATURE) TO DETERMINE TOTAL GALLONS/MINUTE (GPM) OR LITERS PER SECOND (L/S) AND FIND UNIT'S MINIMUM FLOW RATE.

TOTAL GPM (L/S): \_\_\_\_\_

GPM/NOMINAL TON (L/S PER TON) = \_\_\_\_\_

- TOTAL GPM (L/S) IS GREATER THAN UNIT'S MINIMUM FLOW RATE
- TOTAL GPM (L/S) MEETS JOB SPECIFIED REQUIREMENT OF \_\_\_\_\_ GPM (L/S)
- COOLER HEATER FUSE INSTALLED, AND HEATERS ARE ACTIVE (IF USED)

**CHECK CONDENSER WATER LOOP:**

PROPER LOOP CORROSION INHIBITOR INCLUDED  
\_\_\_\_\_ GALLONS (LITERS) OF \_\_\_\_\_

INLET PIPING TO CONDENSER INCLUDES A 40 MESH STRAINER

**CHECK PRESSURE DROP ACROSS THE CONDENSER (30HXC ONLY):**

ENTERING CONDENSER: \_\_\_\_\_ PSIG (kPa)

LEAVING CONDENSER: \_\_\_\_\_ PSIG (kPa)

(LEAVING – ENTERING) × 2.31 FT OF H<sub>2</sub>O = \_\_\_\_\_ FT OF H<sub>2</sub>O

(LEAVING – ENTERING) × 0.334 M OF H<sub>2</sub>O/kPa = \_\_\_\_\_ M OF H<sub>2</sub>O

PLOT CONDENSER PRESSURE DROP ON PERFORMANCE DATA CHART (IN PRODUCT DATA LITERATURE) TO DETERMINE TOTAL GALLONS/MINUTE (GPM) OR LITERS PER SECOND (L/S) AND FIND UNIT'S MINIMUM FLOW RATE.

TOTAL GPM (L/S): \_\_\_\_\_

GPM/NOMINAL TON (L/S PER TON) = \_\_\_\_\_

- TOTAL CONDENSER GPM (L/S) IS GREATER THAN UNIT'S MINIMUM FLOW RATE
- TOTAL GPM MEETS JOB SPECIFIED REQUIREMENT OF \_\_\_\_\_ GPM (L/S)



**PERFORM TEST FUNCTION (INDICATE POSITIVE RESULT):**

ONCE POWER IS SUPPLIED TO THE UNIT, CHECK THE DISPLAY FOR ANY ALARMS, SUCH AS PHASE REVERSAL. FOLLOW THE TEST FUNCTION INSTRUCTIONS IN THE CONTROLS AND TROUBLESHOOTING LITERATURE. BE SURE TO CHECK FOR PROPER FAN ROTATION WITH THE FAN TEST SECTIONS. BE SURE ALL SERVICE VALVES ARE OPEN BEFORE BEGINNING THE COMPRESSOR TEST SECTION. ITEMS MARKED WITH “†” CAN BE TESTED ONLY IF THE UNIT IS CONFIGURED FOR THIS OPTION. DO NOT RUN OIL PUMPS FOR MORE THAN 20 SECONDS.

**1** **TEST ALARM**

- LOADER A1
- LOADER A2
- MINIMUM LOAD VALVE A†
- CIRCUIT A OIL HEATER
- A1 MOTOR COOLING SOLENOID
- A2 MOTOR COOLING SOLENOID†
- CIRCUIT A OIL PUMP
- OIL SOLENOID A1
- OIL SOLENOID A2†

**2** **TEST ALARM**

- LOADER B1
- LOADER B2
- MINIMUM LOAD VALVE B†
- CIRCUIT B OIL HEATER
- B1 MOTOR COOLING SOLENOID
- B2 MOTOR COOLING SOLENOID†
- CIRCUIT B OIL PUMP
- OIL SOLENOID B1
- OIL SOLENOID B2†

**4** **TEST ALARM**

- CIRCUIT A EXV
- CIRCUIT B EXV
- CIRCUIT A WATER VALVE†
- CIRCUIT A% FAN SPEED (GX)†
- CIRCUIT B% FAN SPEED (GX)†

**3** **TEST ALARM**

- FAN 1 (30GX)†
- FAN 2 (30GX)†
- FAN 3 (30GX)†
- FAN 4 (30GX)†
- FAN 5 (30GX)†
- FAN 6 (30GX)†

**8** **SRVC**

- COMPRESSOR A1
- COMPRESSOR A2†
- COMPRESSOR B1
- COMPRESSOR B2†

- COOLER PUMP†
- CONDENSER PUMP†
- COOLER HEATER†
- ALARM RELAY†

CHECK FOR COMMUNICATING MODULES (BLINKING RED AND GREEN LEDs)

CORRECT FLUID SET POINTS ARE ENTERED

**1** **SET**

COOL SET POINT 1 \_\_\_\_\_

COOL SET POINT 2 \_\_\_\_\_

CORRECT DATE, TIME, AND OPERATING SCHEDULE(S) ARE SET

REVIEW AND RECORD FACTORY CONFIGURATION CODES,  5  SRVC

CONFIGURATION CODE 1: \_\_\_\_\_

CONFIGURATION CODE 2: \_\_\_\_\_

CONFIGURATION CODE 3: \_\_\_\_\_

CONFIGURATION CODE 4: \_\_\_\_\_

CONFIGURATION CODE 5: \_\_\_\_\_

REVIEW AND RECORD SOFTWARE VERSION,  1  SRVC

SOFTWARE CESR500100 VERSION \_\_\_\_\_

REVIEW AND RECORD FIELD CONFIGURATION,  2  SRVC

COOLER FLUID SELECT \_\_\_\_\_

COOLER PUMP CONTROL \_\_\_\_\_

MIN LOAD VALVE SELECT \_\_\_\_\_

CONDENSER PUMP CONTROL \_\_\_\_\_

LOADING SEQ. SELECT \_\_\_\_\_

CONDENSER FLOW SWITCH \_\_\_\_\_

LEAD/LAG SEQ. SELECT \_\_\_\_\_

CONDENSER WATER SENSORS \_\_\_\_\_

HEAD PRESSURE CONTROL \_\_\_\_\_

MOTORMASTER SELECT \_\_\_\_\_

WATER VALVE TYPE \_\_\_\_\_

EXTERNAL RESET SENSOR \_\_\_\_\_

COOLER PUMP INTERLOCK \_\_\_\_\_

#### TO START THE CHILLER:

BE SURE THAT ALL SERVICE VALVES ARE OPEN, AND ALL PUMPS ARE ON BEFORE ATTEMPTING TO START THIS MACHINE. ONCE ALL CHECKS HAVE BEEN MADE, MOVE THE SWITCH TO "LOCAL" OR "REMOTE" FROM "STOP."

UNIT STARTS AND OPERATES PROPERLY.

#### TEMPERATURES AND PRESSURES:

ONCE THE MACHINE HAS BEEN OPERATING FOR A WHILE AND THE TEMPERATURES AND PRESSURES HAVE STABILIZED, RECORD THE FOLLOWING:

COOLER EWT \_\_\_\_\_

COOLER LWT \_\_\_\_\_

AMBIENT TEMPERATURE \_\_\_\_\_

CONDENSER EWT  
(ENTERING WATER TEMP) \_\_\_\_\_

CONDENSER LWT  
(LEAVING WATER TEMP) \_\_\_\_\_

CIR. A OIL PRESS \_\_\_\_\_

CIR. A SUCTION PRESS \_\_\_\_\_

CIR. A DISCHARGE PRESS \_\_\_\_\_

CIR. A DISCHARGE TEMP \_\_\_\_\_

CIR. A LIQUID LINE TEMP \_\_\_\_\_

CIR. B OIL PRESS \_\_\_\_\_

CIR. B SUCTION PRESS \_\_\_\_\_

CIR. B DISCHARGE PRESS \_\_\_\_\_

CIR. B DISCHARGE TEMP \_\_\_\_\_

CIR. B LIQUID LINE TEMP \_\_\_\_\_

NOTE: OIL FILTER PRESSURE DROPS MUST BE CHECKED AFTER INITIAL 200-300 HOURS OF COMPRESSOR OPERATION. SEE OIL FILTER MAINTENANCE SECTION, PAGE 56.

NOTES:

---

---

---

---

---

---

**Manufacturer reserves the right to discontinue, or change at any time, specifications or designs without notice and without incurring obligations.**