

# **MULTISTACK**<sup>®</sup>

Originators. Innovators. Never the Imitators.<sup>SM</sup>

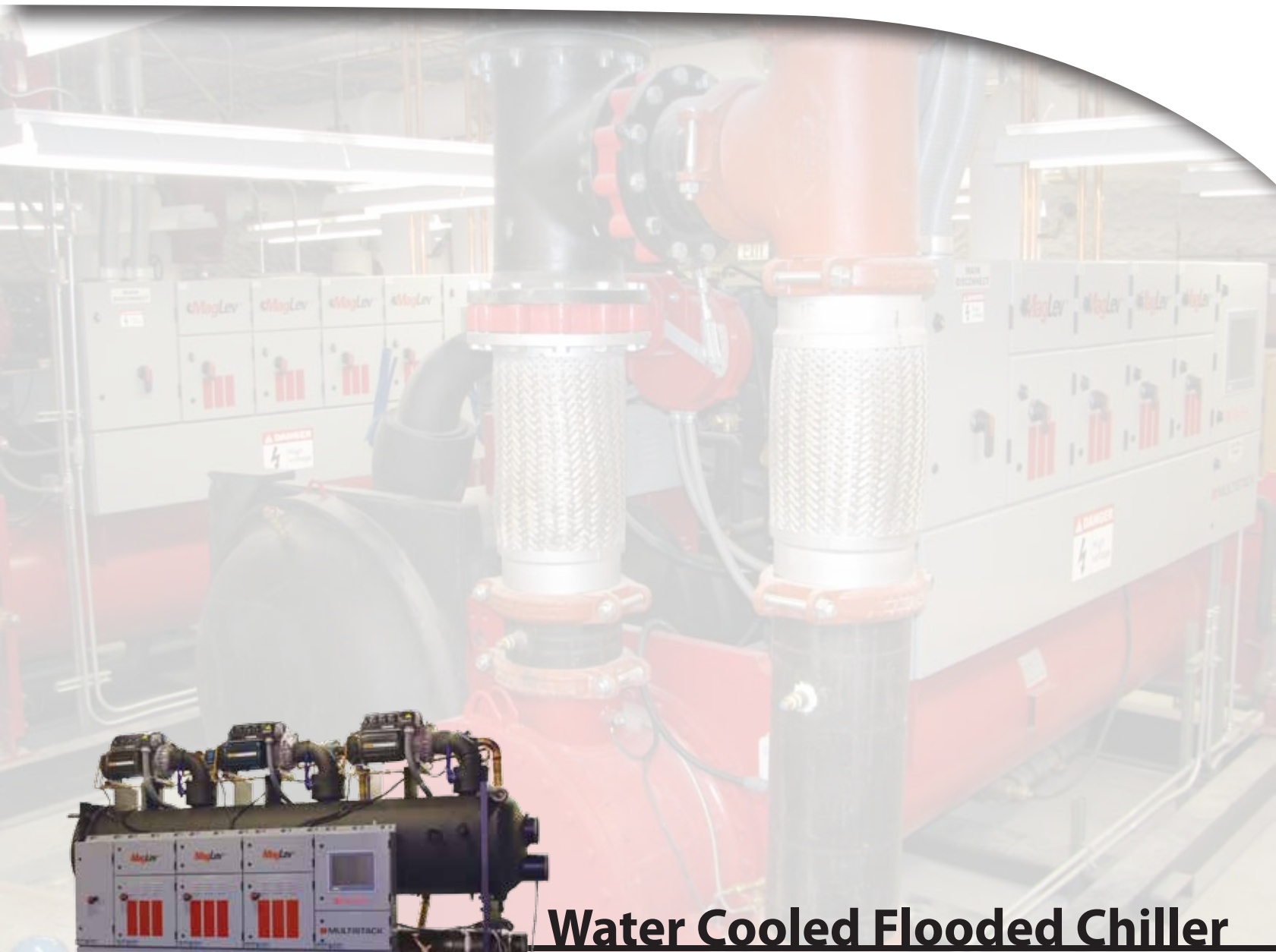

## **Water Cooled Flooded Chiller Product Data Catalog**

**For Modules sized from 60 Tons to 600 Tons**

## Table of Contents

Introduction .....	3
MagLev™ Chiller Overview .....	6
Controls.....	10
Available Sizes .....	15
Performance Data .....	16
Evaporator Data .....	17
Condenser Data .....	18
Model Overview .....	19
Electrical Data.....	21
MagLev™ Centrifugal Product Specification .....	22
About Multistack® .....	29

## Model Number Nomenclature

### Existing

MS300 F 1 L 2 W 2 H 1 R134a

### New

MS	0300	F	C/N	1	L	2	W	2	H	1	A	A	1	1	-134a
															Refrigerant
															Condenser (entering) <sup>4</sup>
															Evaporator (entering) <sup>3</sup>
															Condenser Tube Type <sup>2</sup>
															Evaporator tube type <sup>1</sup>
															Version number of AHRI Certification
															Voltage (H - 460/3/60, C for 575/3/60, E for 400/3/50)
															Number of condenser water passes
															Condenser Type (W for water cooled, R - remote air cooled, E - remote evap cooled)
															Number of evaporator water passes
															Shell Length (S - 6 foot, L - 12 foot)
															Frame Style (1,2,3 or 4)
															AHRI Certified (C - certified, N - Not certified)
															Evaporator Type (F for Flooded)
															Module Nominal Capacity (up to 4 digits)
															Series

<sup>1</sup> A - B4 copper, B- B4 Cu-Ni, C - B5 copper, D - C5 Cu-Ni, V - other

<sup>2</sup> A - C4 copper, B- C4 Cu-Ni, C - C5 copper, D - C5 Cu-Ni, V - other

<sup>3</sup> 1- Standard water box left, 2 - Standard water box right, 3 - Marine water box left, 4 - Marine water box right

<sup>4</sup> 1- Standard water box left, 2 - Standard water box right, 3 - Marine water box left, 4 - Marine water box right



In a world that confuses real technology with trendy gadgets, product quality can only be viewed—and verified—with measured performance. Multistack® MagLev® flooded chillers have been built from the ground up to be the industry standard in performance, reliability, redundancy and serviceability for oil free chiller technology. Simply put...MagLev flooded chillers bring high-definition clarity to a confused world.

With over 20 years of successfully designing, patenting and producing industry leading modular chillers, the development team at Multistack set out on an extensive 2 ½ year project. The result was the creation of a revolutionary new family of energy efficient, technologically superior chillers known as the MagLev Flooded Chiller line and the new industry standard in controls, FlexSys.

A shift in the air conditioning industry focus from inefficient, constant-volume air distribution to energy saving variable-volume air flow revealed a need to seek three specifics that the MagLev chiller diversity is based upon.

### 1. Energy Diversity

MagLev compressors attain optimum efficiency while operating at part load. This creates an operational strategy to run multiple compressors at part-load—for as long as possible-- to achieve the lowest Kw/Ton. As cooling loads decline, the Multistack FlexSys controller adapts to the lowest Kw/Ton strategy including shutting down compressors to meet cooling requirements. This proprietary adaptive control logic allows a 450 ton chiller to provide as little as 40 to 50 tons of off-hour cooling at .33 kW/Ton. Energy Diversity is the ability to utilize multiple compressors to function at part-load on oversized shells. This ability matches and optimizes part-load performance to meet building demands all day—not just during peak use.

### 2. Functional Diversity

Redundancy in a chiller system is important—but often overlooked due to cost restraints. For the first time in the world of flooded chillers, multiple MagLev compressors mounted on a common shell now offers a new form of functional diversity previously beyond the budget considerations of most cooling projects--redundancy. If a single compressor fails on a MagLev flooded chiller, the other compressors still run and provide cooling. Additionally, traditional large tonnage centrifugals become increasingly inefficient below 50% capacity. The standard fix is the installation of a costly, fairly inefficient after hours chiller. MagLev flooded chillers are designed with multiple, VFD Driven MagLev compressors that cost effectively and efficiently provide the functional diversity of a after hours chiller--without cost of a separate system.

### 3. Operational Diversity

Here are several operational advantages that are created by a chiller that incorporates multiple MagLev compressors:

- In the unlikely event of a compressor failure the other compressors will continue to operate until the downed unit is returned to service.
- Temporary cooling rentals necessitated when a large tonnage machine fails can almost be eliminated by the built-in redundant design of MagLev flooded chillers.
- If a compressor does fail and needs to be replaced, it can be accomplished by two (2) technicians without the necessity of large cranes or other specialized rigging equipment.
- Maintenance routines are simplified and easily completed without system shutdowns. Individual compressors can be shut down for maintenance without requiring the entire system to go off line.



# MagLev Water-Cooled Flooded

## INTRODUCTION

The emerging green economy demands that we focus on energy efficiency and protect the environment while dramatically reducing our carbon footprint. Multistack is leading the way to a better tomorrow through technical advances available today.

### Long Shell

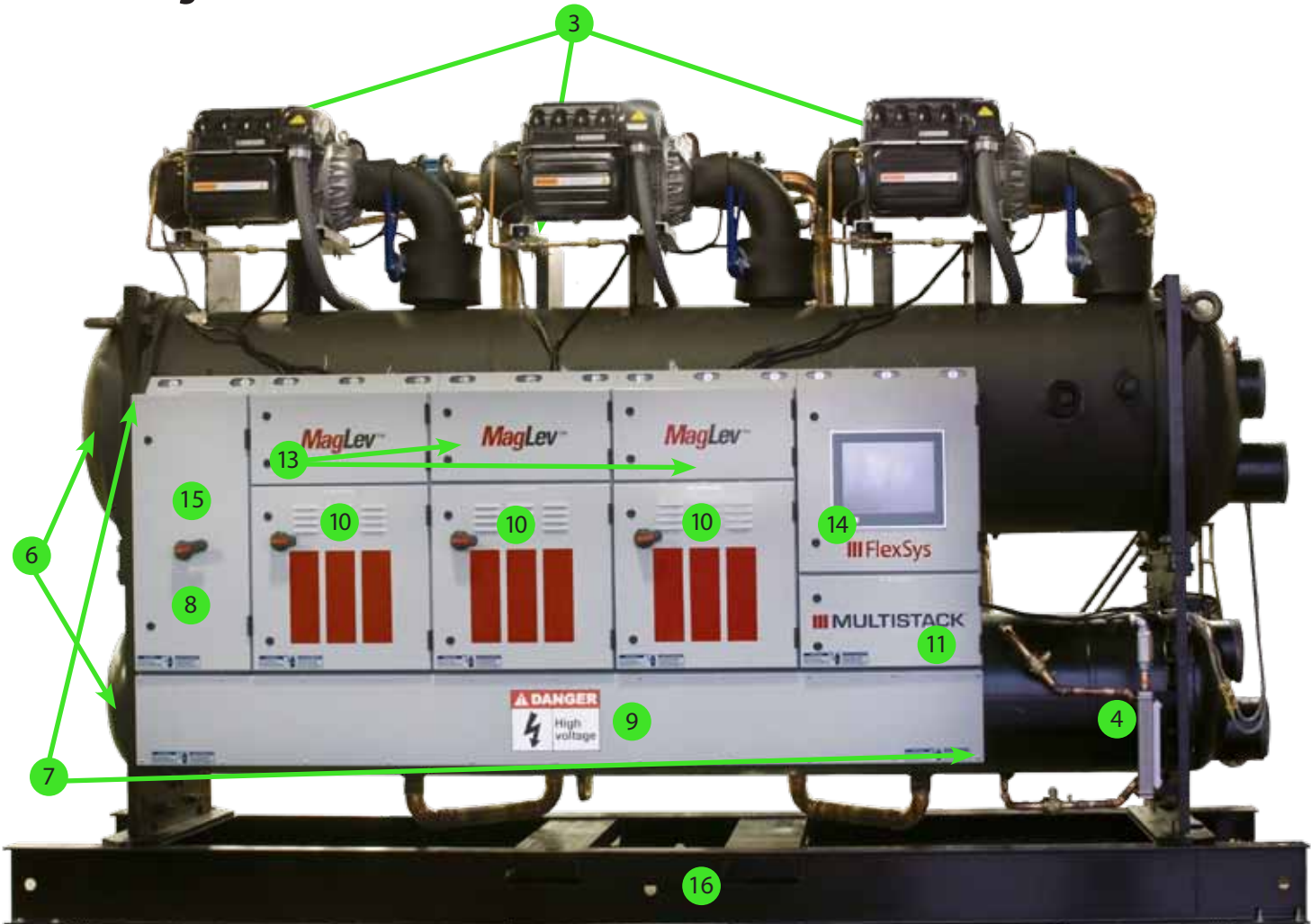

- |  |   |
|--|---|
| 3- Load Balancing Valve on Each Compressor           | 10- Individual Breakers for Each Compressor           |
| 4- Liquid Level Sensor with Sight Glass              | 11- Isolated Control Power Feeds for Increased Safety |
| 6- Advanced Heat Exchangers                          | 13- Compressor Hub System                             |
| 7- First-In-Class Electrical Enclosures              | 14- FlexSys Control System with 15" Touch Screen      |
| 8- Single Point of Electrical Connection for Chiller | 15- Unit Mounted Disconnect                           |
| 9- Buss Bar Power Distribution                       | 16- Lifting Frame (optional)                          |

## Short Shell

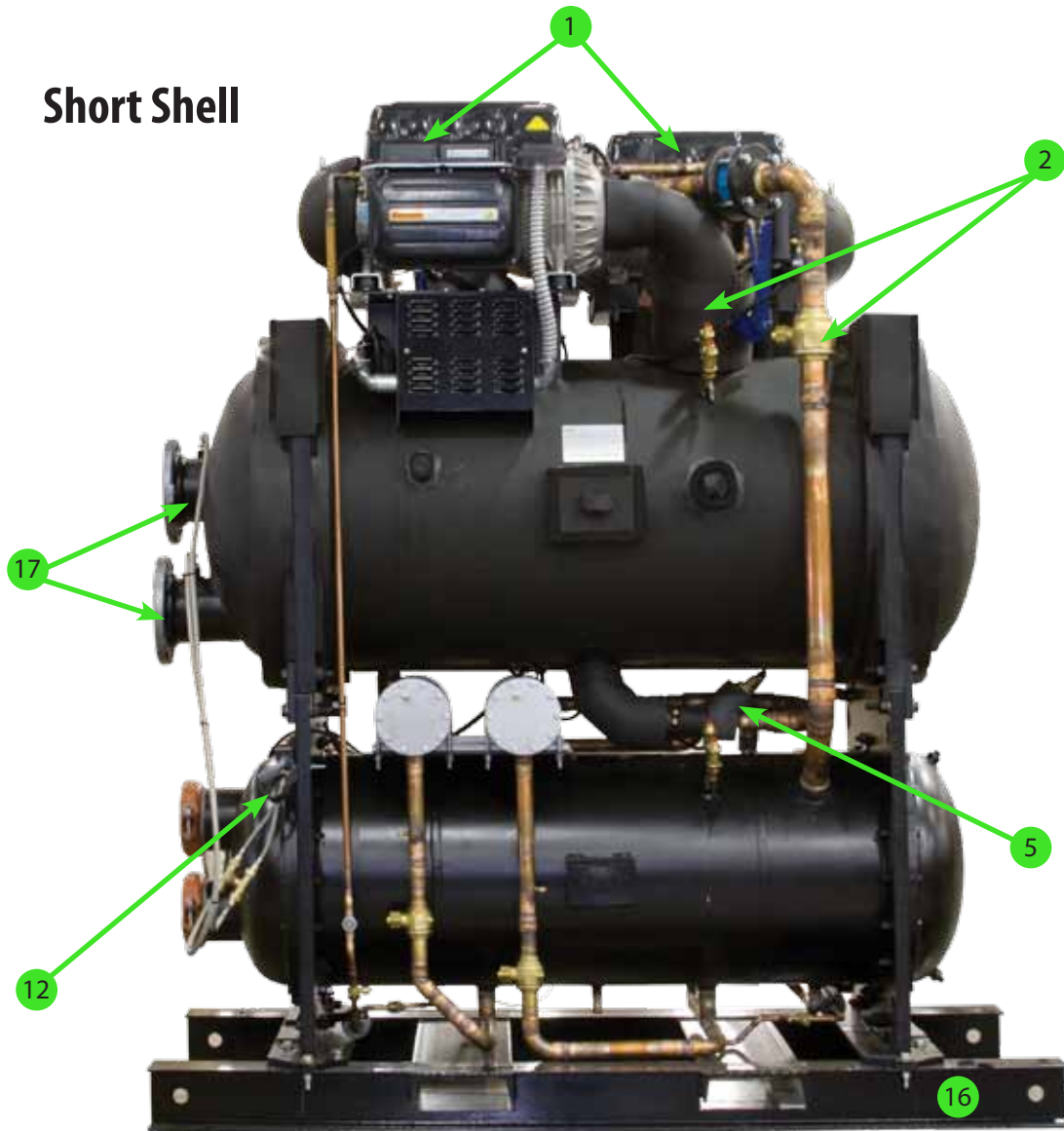

- |  |  |
|--|--|
| 1- Oil-Free MagLev Centrifugal Compressors   | 12- Factory Mounted Differential Pressure Transmitters |
| 2- Isolation Valves on Each Compressor       | 16- Lifting Frame (optional)                           |
| 5- Dual Electronic Expansion Valves Standard | 17- Flange Connections (optional)                      |

# MagLev Water-Cooled Flooded

## 60 - 450 TON CHILLER DRAWING

The drawings on this page are for point of reference only. Job specific drawings will be created as orders are placed.

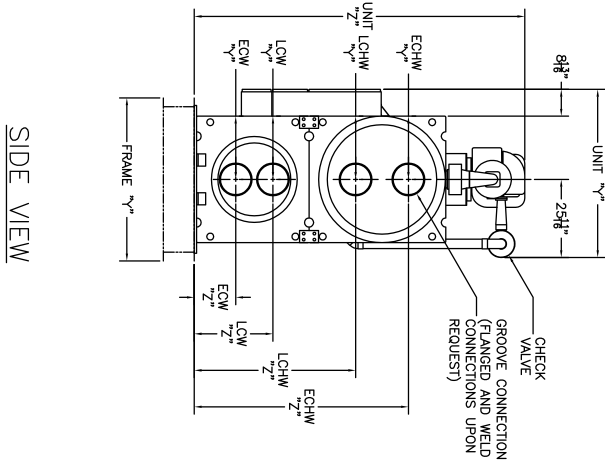
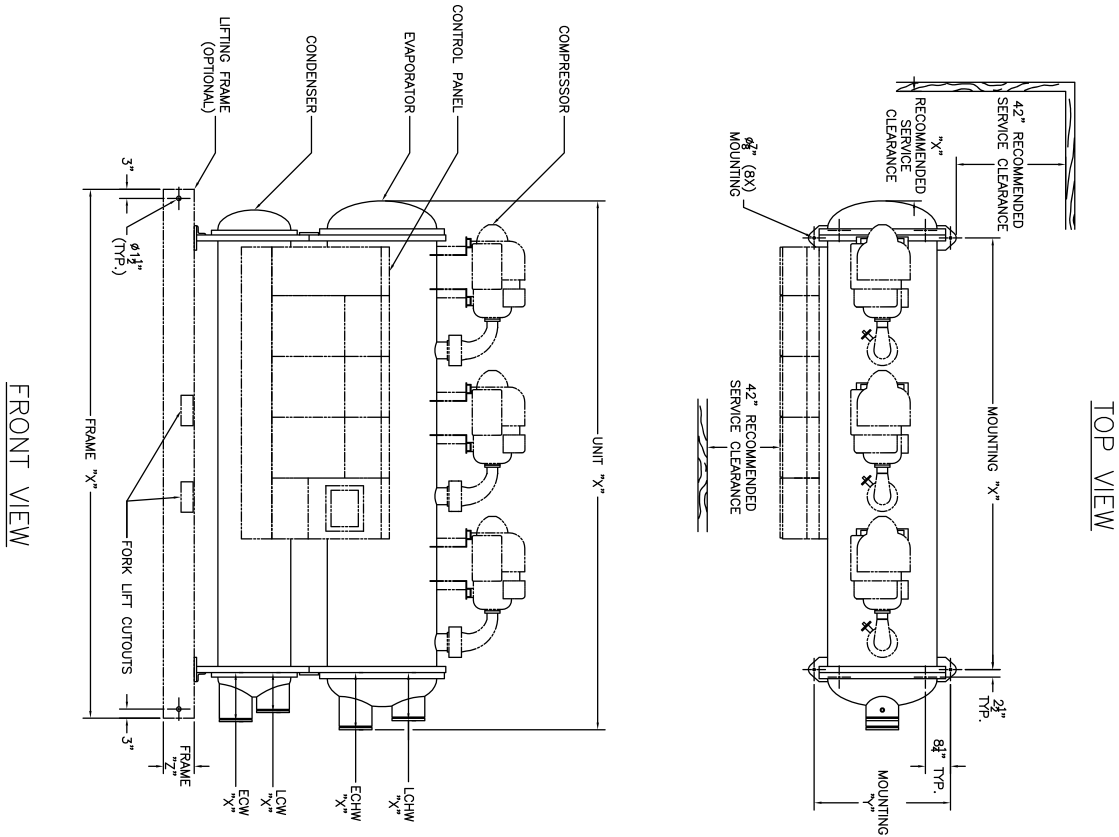

UNIT SIZE	CONNECTION TYPE	WATER CONNECTION SIZE	LOCATION 'X'	LOCATION 'Y'	LOCATION 'Z'	WEIGHT (LBS)	# OF COMP.	SERVICE CLEAR. 'X'
MS0090FS	ECHW	1 1/4	168	49 1/2	11	144	1	144
	LCHW	1 1/4	168	40 1/2	11	144	1	144
	ECW	1 1/4	10 1/2	11 1/2	10	11 1/2	10	19
MS0180FL	ECHW	1 1/2	118	57 1/2	14	144	2	144
	LCHW	1 1/2	118	44 1/2	14	144	2	144
	ECW	1 1/2	12 1/2	12 1/2	12	12 1/2	12	22 1/2
MS0090FL	ECHW	1 1/4	10 1/2	44 1/2	10	10 1/2	10	10 1/2
	LCHW	1 1/4	10 1/2	36 1/2	10	10 1/2	10	10 1/2
	ECW	1 1/4	8	10 1/2	8	10 1/2	8	10 1/2
MS0180FL	ECHW	1 1/2	11 1/2	48 1/2	11 1/2	11 1/2	11 1/2	11 1/2
	LCHW	1 1/2	11 1/2	35 1/2	11 1/2	11 1/2	11 1/2	11 1/2
	ECW	1 1/2	12	12	12	12	12	18 1/2
MS0240FL	ECHW	1 1/2	14 1/2	54 1/2	11	14 1/2	11	14 1/2
	LCHW	1 1/2	14 1/2	45 1/2	13	14 1/2	11 1/2	14 1/2
	ECW	1 1/2	10	14 1/2	10	14 1/2	10	21 1/2
MS0300FL	ECHW	1 3/4	15 1/2	60 1/2	12 1/2	15 1/2	12 1/2	15 1/2
	LCHW	1 3/4	15 1/2	48 1/2	13 1/2	15 1/2	12 1/2	15 1/2
	ECW	1 3/4	15 1/2	24 1/2	9 1/2	15 1/2	15 1/2	24 1/2
MS0390FL	ECHW	1 3/4	17 1/2	61 1/2	13 1/2	17 1/2	13 1/2	17 1/2
	LCHW	1 3/4	17 1/2	49 1/2	13 1/2	17 1/2	13 1/2	17 1/2
	ECW	1 3/4	13 1/2	17 1/2	13 1/2	17 1/2	13 1/2	14 1/2
MS0450FL	ECHW	1 3/4	20 1/2	70 1/2	15 1/2	20 1/2	15 1/2	20 1/2
	LCHW	1 3/4	20 1/2	55 1/2	16 1/2	20 1/2	15 1/2	20 1/2
	ECW	1 3/4	20 1/2	25 1/2	13 1/2	20 1/2	13 1/2	25 1/2
MS0600FL	ECHW	1 3/4	23 1/2	78 1/2	16 1/2	23 1/2	16 1/2	23 1/2
	LCHW	1 3/4	23 1/2	58 1/2	17 1/2	23 1/2	16 1/2	23 1/2
	ECW	1 3/4	23 1/2	14 1/2	14 1/2	23 1/2	14 1/2	28 1/2

UNIT SIZE	OVERALL UNIT DIMENSIONS (IN) (WITHOUT LIFTING FRAME)			WEIGHTS (LBS)		MOUNT SPACING (IN)		LIFTING FRAME ONLY DIMENSIONS (IN)		# OF CLEAR.				
	'X'	'Y'	'Z'	DRY	RETIRG WATER	'X'	'Y'	'X'	'Y'					
MS0090FS	93 3/8	47 1/2	100	5000	5350	5400	70 1/2	32 1/2	90	36 1/2	6	500	1	72
MS0180FS	163 3/8	45	90	4500	4850	4900	142 1/2	29 1/2	174	33 1/2	6	650	1	144
MS0180FL	165 1/8	46 1/2	90	7000	7630	7750	142 1/2	32 1/2	174	36 1/2	6	675	2	144
MS0240FL	166 1/8	48 1/2	97	8500	9340	9500	142 1/2	32 1/2	174	42 1/2	10 1/2	1000	2	144
MS0300FL	168 1/8	50	114	10250	11300	11500	142 1/2	36 1/2	174	45 1/2	10 1/2	1025	2	144
MS0390FL	170 1/8	52 1/2	114	13000	14365	14550	142 1/2	40 1/2	174	49 1/2	10 1/2	1050	3	144
MS0450FL	174	55 1/8	121	16250	17825	18050	142 1/2	44 1/2	174	53 1/2	10 1/2	1100	3	144
MS0600FL	178 1/2	68	144	23500	25600	25955	142 1/2	50 1/2	174	59 1/2	15 1/2	1300*	4	144

\* ESTIMATED VALUE

# MagLev Water-Cooled Flooded

## 500 - 600 TON CHILLER DRAWING

The drawings on this page are for point of reference only. Job specific drawings will be created as orders are placed.

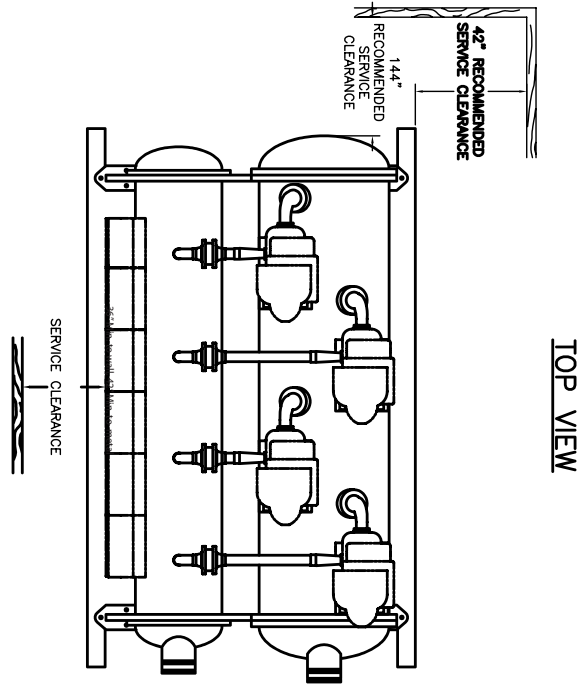

TOP VIEW

Typical even pass diagram.

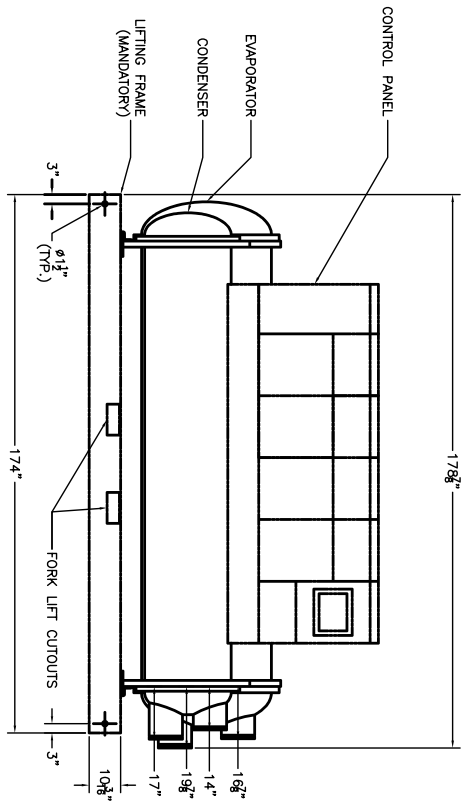

FRONT VIEW

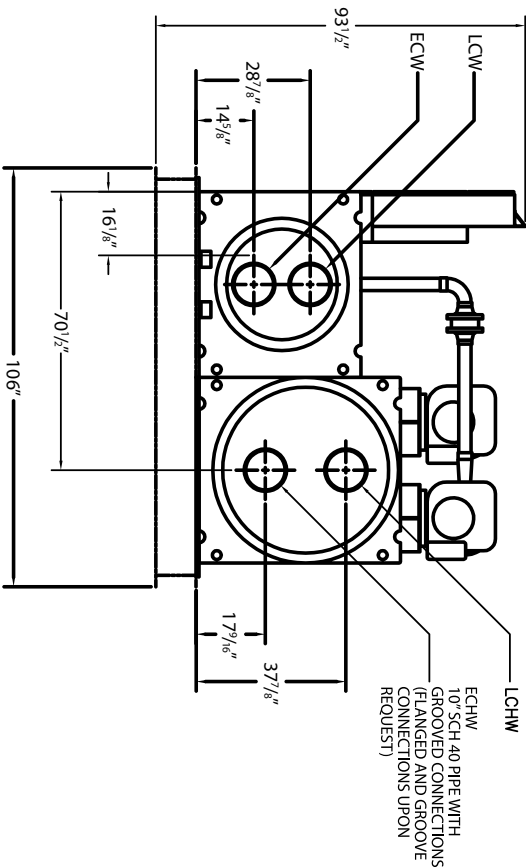

SIDE VIEW

OVERALL WEIGHT (LBS) (WITH LIFTING FRAME)		
DRY	REFRIG	WATER
25000	27100	27455

# MagLev Water-Cooled Flooded

## CHILLER OVERVIEW

### Oil-Free MagLev Centrifugal Compressors-

The direct result of aerospace and industrial technologies converging with advanced digital controls to provide a light weight, mechanically robust two-stage centrifugal compressor. This technology allows for industry leading energy efficiency, reliability, and redundancy through the use of multiple smaller compressors on a common refrigerant circuit. Compressors feature a patented magnetic bearing system that eliminates vibration with only one major moving part. This design leads to ultra quiet operation with sound levels as low as 70 DBA.



### Isolation Valves on Each Compressor-

With multiple compressors on a single refrigerant circuit, it doesn't make sense to recover the entire refrigerant charge for service. Each compressor is equipped with an individual discharge, suction and motor cooling service valve. This allows compressor isolation for service or maintenance, if required.

*Discharge Service Valve*



*Suction Service Valve*



*Motor Cooling Isolation Valve*

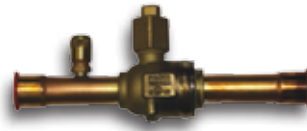

### Load Balancing Valves on Each Compressor-

By adding a Load Balance Valve to each compressor, there is no need for a dedicated lead/lag sequence on the compressors. Starting sequence for compressors takes seconds as opposed to minutes through the use of the load balance valves and proprietary FlexSys Adaptive Start Logic. Three benefits of this design are:

1. Eliminates faults caused by shaft instability due to starting against elevated head pressures or lack of refrigerant flow.
2. Eliminates any thermal lag caused from the chiller unloading to start additional compressors.
3. Decreases energy consumption because lag compressor starting will not cause a power spike.

Unloading is improved as the Load Balance Valve works in conjunction with the compressor to extend the compressors operating envelope. This allows for lower minimum capacities which help in low load or critical applications such as process cooling.



### Condenser Liquid Level Sensor-

All Multistack MagLev flooded chillers are equipped with a condenser liquid level sensor. In addition, there is a second sight glass located on the side of the level sensor, mounted off the condenser. The canister has a full length sightglass providing a window for the technician to see what is happening with liquids and ensure proper system operation.





### Dual Electronic Expansion Valves Standard-

All Multistack MagLev chillers with multiple compressors feature two electronic expansion valves for maximum redundancy and reliability. This feature allows the chiller to run on one or two valves to always meter the proper amount of refrigerant. By using electronic valves in conjunction with level control, MagLev chillers are able to unload further than chillers with one large EXV, TXVs, or orifices.



### Advanced Heat Exchangers-

Aimed at providing the absolute best balance of chiller turn down versus pump power consumption, MagLev heat exchangers were designed to provide customers with exceptional 4:1 water side turn down. All MagLev heat exchangers are selected in each size range to optimize the chillers water side performance. This allows for great versatility with all pumping configurations. MagLev heat exchangers are offered in a variety of pass configurations and shell lengths to meet your specific application needs.

### 100% Oil Free Design-

Through extensive laboratory testing and a study done by ASHRAE, Research Project 601, it was concluded that oil has very costly consequences which lead to energy inefficiency because of oil logging in the heat exchangers. Large centrifugal chillers that use oil have higher operating and maintenance costs due to required annual service (oil changes, oil samples, oil filters, leaks) and the use of sump heaters. In addition, oil logging dramatically affects chiller performance over its lifetime.

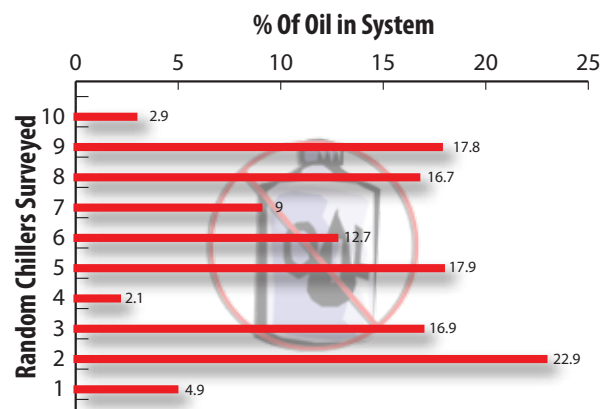

### Environmentally Friendly R-134A-

With the proclamation of the Montreal Protocol, refrigerants such as R-11 and R-22 were assigned scheduled phase-out dates due to their high ozone depletion factors — new equipment can no longer be produced with these refrigerants. Currently, R-134A has no phase out date, is considered a green refrigerant and is used in MagLev Chillers.

# MagLev Water-Cooled Flooded CHILLER OVERVIEW

## First-In-Class Electrical Enclosures-

All enclosures on Multistack MagLev Flooded Chillers are UL listed. Features include: fully vented, louvered panels with FlexSys controlled cooling fans for maximum energy efficiency. A modular panel design provides simplistic trouble shooting, voltage separated cabinets for maximum resistance to transient voltages, EMI noise and increased safety.



## Single Point Of Electrical Connection-

Field installation time is decreased by MagLev single point electrical connection design. Chiller mounted breaker is optional and can be specified.

## Buss Bar Power Distribution-

All MagLev flooded chillers utilize a copper buss bar system for ease of connection. This allows the high voltage for each power panel to be in line with the buss and isolated. Also, it eliminates using multiple electrical enclosures as pull boxes. Buss bars have also been found to be more resistant to EMI noise.

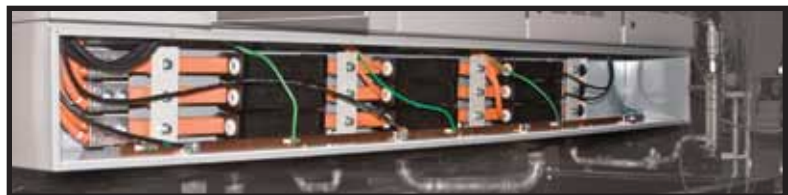

## Individual Breakers-

The need to isolate each compressor with individual breakers, while allowing other compressors to operate, only makes sense. This provides for better serviceability and redundancy. Ninety-five percent of all MagLev Flooded chillers in the world today are built using multiple compressors.



### Isolated Control Power Feeds-

High voltage components are isolated from all control components for increased safety during service. This feature prevents electrical interference from the high voltage electrical to the system and compressor controls, which increases reliability.

### Factory Mounted Differential Pressure Transmitters-

All Multistack MagLev chillers come with factory installed differential pressure transmitters on the evaporator and condenser. The transmitters are plumbed and wired into the control system to decrease field installation requirements. Flow transmitters are used for protection in place of flow switches, which can flutter when used in variable flow applications and causing nuisance trips. The transmitters are also used to help determine real time chiller performance.



### Compressor Hub System-

The FlexSys Hub System isolates all compressor communication, interlocks, and safeties locally within each compressor. This feature allows for precise control, maximum redundancy, and efficient real time communication to each compressor through an Ethernet connection. Available in the first quarter of 2010, each hub will feature a small micro processor that will act as a bypass to each compressor for redundancy usually reserved for mission critical applications.

### FlexSys Control System with 15" Touch Screen-

At the heart of every MagLev chiller is the FlexSys control system with a 15" touch screen. With the most advanced technology found in the HVAC industry, FlexSys opens a whole new world of compressor control, chiller control, and system control. Please see the controls overview on Page 10 for additional information.



### Features—Software

The MagLev™ FlexSys Controller includes these unique software features:

- Control of up to eight (8) MagLev compressors of varying capacities using either single or multiple circuits.
- On-site individual compressor and system fine tuning using the MagLev™ FlexSys touch-screen display panel.
- Proprietary MagLev™ FlexSys optimization logic maintains energy balances for all systems maximizing energy and operational performance.
- Two (2) year data log, trend graphing in five-second intervals, and exportable .jpg or .csv images.
- Fault logging features a calendar mode with the ability to sort by alarm type, time stamp or by individual compressor.
- MagLev™ FlexSys can be reconfigured via the touch-screen for custom system integration between the chiller and the building.
- MagLev™ FlexSys features on-board manuals, wiring diagrams and support data that are all accessible through the touch-screen panel.
- Built-in web interface provides full remote control including fault notification via e-mail.
- On-board DTC software eliminates the need for a service technician to carry a portable computing device.
- Full BAS connectivity including Modbus®, BacNet® and Lon®.
- MagLev™ FlexSys controller can manage up to 24 electronic expansion valves. EXV control is integrated into system I/O to eliminate additional hardware
- FlexSys System can save and recall all of the chiller settings that have been programmed.
- Windows Operating System can fail and the chiller will continue to run on built-in redundant software.

### Features—Hardware

Multistack® selected high-end, fail-safe hardware features:

- Windows based, on-board high resolution PC for maximum reliability and performance
- Dual drive design insures redundancy, reliability and eliminates the need for partitioning.
- Drives have no moving parts, eliminating the possibility of mechanical failure.
- 15-inch touch-screen display has 1024 x 768 resolution and an interface that eliminates the need for on-site laptop connectivity.
- DC Power ensures maximum resistance to on-site EMI and RFI noise.
- On-board industrial grade battery back-up for power outage protection.
- Modular I/O design simplifies troubleshooting by utilizing LED indicators for all inputs and outputs
- Wiring uses spring capture technology to assure positive connections and eliminate traditional terminal blocks.
- MagLev™ Hub System provides dedicated Ethernet communication to all system compressors ensuring fast, reliable communication.

The software in the FlexSys control system works in conjunction with the compressor hubs creating the next generation of chiller control. Most control systems look at leaving water temperature with a single PID loop and convert this into a single demand signal that is applied to all compressors. This affects loading characteristics of the chiller, that can either be too slow or too fast. Too slow can create thermal lag, which eventually forces a chiller to load harder to catch the set point of the chilled water loop. Too fast causes a rubber band effect where the chiller loads very aggressively, becomes unstable, and ultimately forces the chiller to unload rapidly once you have made set point. This type of control logic can create amperage alarms and faults, suction alarms or faults, high pressure alarms or faults, and energy spikes. This can affect the chiller's reliability, energy efficiency, and overall performance in the chilled water system.

With FlexSys controls, each compressor is individually controlled in conjunction with the chiller. This allows for precise, individual control of each compressor, creating a unique system balance where it can run each compressor in the sweet spot to optimize energy efficiency. Sophisticated control like this compensates for any differences in manufacturing tolerances between compressors; allowing for the chiller to adapt to the load efficiently, and preventing thermal lag or drastic overshoot.

Typical control logic architecture on a FlexSys control system:

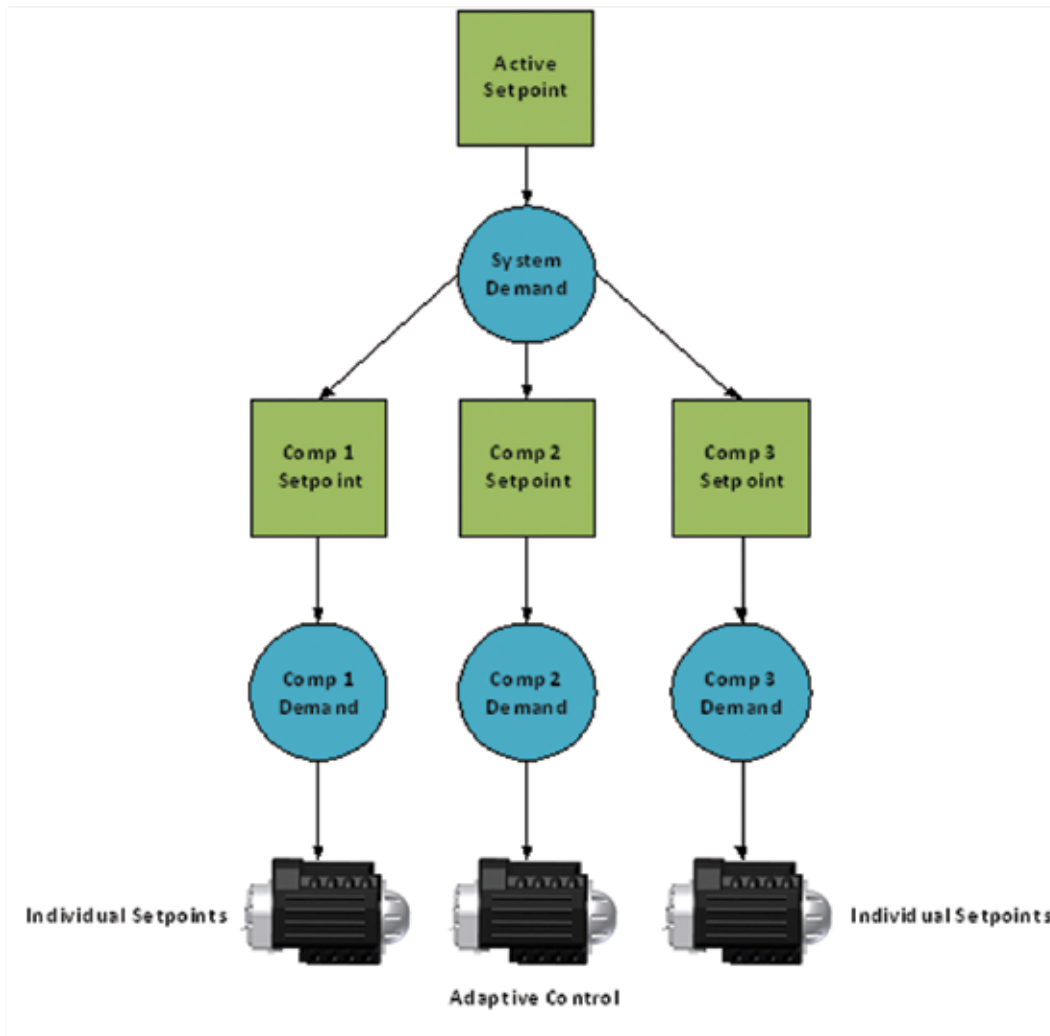

# MagLev Water-Cooled Flooded CONTROLS

For purposes of comparison, we have outlined the capabilities of the two most common control systems in use today against our FlexSys Controller.

Control System Comparison			
Hardware Comparison			
Features	MagLev™ FlexSys Controller	Kiltech Controller	McQuay Microtech II
Modular I/O For Ease of Expansion	√	X	X
LED Indicators For Status Of All Inputs and Outputs	√	X	X
Computer Based Controller (As Opposed To PLC)	√	√	X
Intel Processor On Board	√	X	X
All Hardware DC Power (Less Susceptibility To EMI Noise)	√	X	X
Split Industrial Grade Hard Drives (2 GB Minimum)	√	X	X
Trend Data, Fault Logs, Alarms Can Be Downloaded Via USB	√	√	√
All Hardware CE And UL Approved	√	X	√
15 Inch Touch Screen	√	X	√
Built In EXV Drivers	√	√	X
Dedicated Ethernet Connection To Each Compressor	√	X	X
Dedicated RS-232 and RS-485 To Each Compressor	√	X	X
If Touch Screen Is Disconnected Or Fails, System Will Continue To Run	√	X	√
Compressor Hub Feature To Simplify Compressor Interfacing	√	X	X
Each Hub Has Independent HP/LP Mechanical Safeties (External of Comp Software)	√	X	X
Each Hub Has Its Own Interlock Circuit With Proof From Compressor	√	X	X
All Controller Hardware Features Spring Captured Terminals (No Loose Connections)	√	X	X

Software Comparison			
Features	MagLev™ FlexSys Controller	Kiltech Controller	McQuay Microtech II
FlexSys I/O Layout For Simplistic Customization (I/O Functionality)	√	X	X
System Runs Turbocor Software On-Board To Each Compressor	√	X	X
Capable of Controlling Mis-Matched Compressor Sizes	√	X	X
Capable of Controlling Different Refrigerant Types Simultaneously	√	X	X
Adaptive Compressor Logic Allows For Maximum System Reliability and Energy Savings	√	X	X
Able to Control up to 8 Compressors	√	X	X
Web control Standard On All Control Systems (Requires DSL or Mobile Broadband) No Authorization Required	√	X	X
User Selectable Interface For Main Screen, I/O, and Trend Graphing	√	X	X
All Trends, Faults And Alarms Can Be Remotely Downloaded	√	X	X
User Selectable I/O Function For Control	√	X	X
Tower Control Standard (Without Authorization Code)	√	X	√
Operating Manuals and Technical Documentation Stored In Controller	√	X	√
2 Year Of Trend Data Stored At 5 Second Intervals With Calender Recall Feature	√	X	X
Modbus TCP/IP Or RTU Server Standard For Bas Integration (No Authorization Required)	√	X	X
Compatible With Lon and BAC Net	√	√	√
Controller Logs Every Time A Setting Is Changed and Stores Data To Event Log	√	X	X
Controller Logs Over 200 Data Points (20 Points Per Compressor)	√	X	X
Controls Up To 24 EXV's From Touch Screen (Requires Maglev EXV Controller)	√	X	X
Color Coded Interface (Green = Good; Yellow = Alarm; Red = Fault) For Ease Of Troubleshooting	√	X	X
Control Settings and Can Be Saved, Recalled and Transferred	√	X	X
Ability To Give Specific Names To Controller, Compressor, Valves, I/O Points	√	X	X

√= Included  
X = Not Available

## Master Control Panel

The Master Control Panel is where you will find the processor, touch screen, and all system input and outputs for the chiller. The FlexSys compressor controller contains the following system points:

- Two EXV Outputs
- Eight Digital Inputs
- Eight Digital Outputs
- Ten Analog Inputs
- Eight Analog Outputs (0-10 VDC)
- Eight Temperature Sensor Inputs



*Example of Master Control Panel hardware with defined inputs and outputs for a two compressor system.*

## Compressor Hubs

Located next to each MagLev compressor interface board, the compressor hub is where all the compressor I/O and communications are contained. Each hub communicates directly to the Master Control Panel through an addressable Ethernet connection.

Each compressor hub contains the following points:

- Addressable Ethernet Bus Coupler
- RS-485 Module for compressor communications
- RS-232 Module for compressor monitoring via Turbocor Compressor Software
- Four Digital Inputs
- Two Digital Outputs



*Example of a typical Compressor Hub hardware layout with defined inputs and outputs.*

# MagLev Water-Cooled Flooded CONTROLS

## Home Screen

Referred to as the dash board, this is where a general system summary is found.

Features of this screen include:

- 24 user defined text boxes
- System On/Off switch
- Compressor override controls
- Compressor hub status information
- Navigation buttons-
  - User Menu (requires no pass word) includes: trend Graphs, I/O over-view, fault logs, list of alarms, manuals, log book, and exit button
  - Service Menu (requires password) includes: edit system, edit I/O, edit I/O controls, edit alarms, Modbus set-up for BAS interface, edit main screen, and Turbocor software
- Summary of most recent events
- Power Bar and Capacity read out
- System Messages, System Faults, Alarms, and Status
- Compressor Messages, Faults, Alarms, and Status

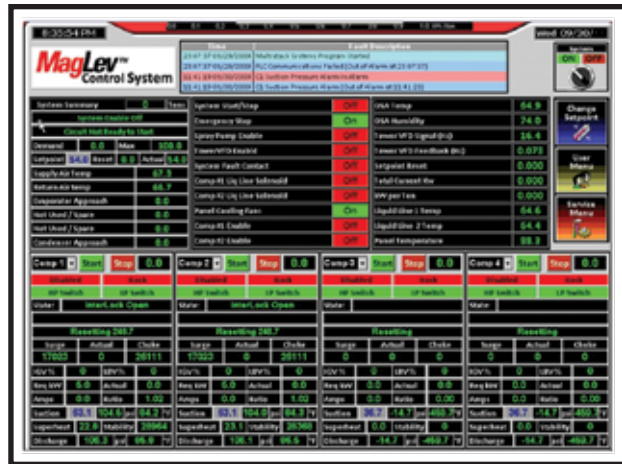

## Trend Graphs

- Over 160,000 points of data stored daily
- All data logged in five-second intervals
- 32 GB of storage data
- Over two years of data can be stored
- Zoom-In / Zoom-Out feature
- Jpg export feature
- Different groupings for system points, compressors, I/O, energy analysis
- User defined viewpoints
- User can change color of trend lines
- Monitors system, hubs and compressors
- Allows accurate system analyzation to identify problems
- Exportable via a .csv file to excel

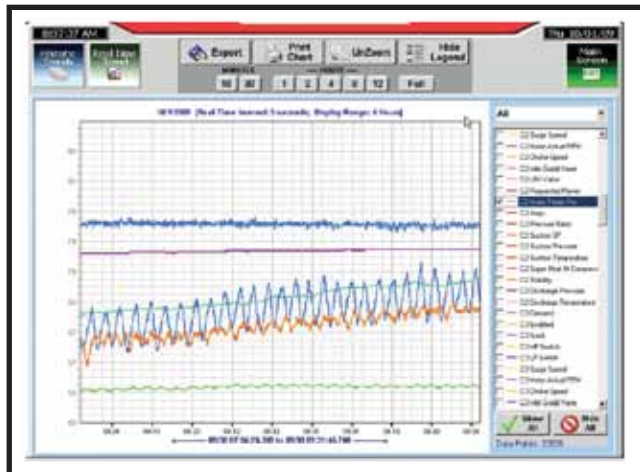



## MagLev Water-Cooled Flooded

### AVAILABLE SIZES

Frame number references in this catalog describe compressor combinations. Since the MagLev centrifugal chiller line allows you to add, subtract or mix compressor configurations to create the best balance of performance, turn down, redundancy, or a combination of all of the above, frame number references are used.

400/460 Volt Flooded Chiller Model Data (Long Shells)						
Model #	Nominal Capacity	Frame 1	Frame 2	Frame 3	Frame 4	
MS0060FL	60 TONS	Not Available				
MS0075FL	75 TONS					
MS0090FL	90 TONS					
MS0120FL	120 TONS	2 Comps: TT-300	1 Comp: TT-400	Not Available		
MS0150FL	150 TONS	2 Comps: TT-300	1 Comp: TT-400			
MS0180FL	180 TONS	2 Comps: TT-300	2 Comps: TT-400			3 Comps: TT-300
MS0210FL	210 TONS	2 Comps: TT-400	Not Available	3 Comps: TT-300	2 Comps: TT-300/TT-400	
MS0240FL	240 TONS	2 Comps: TT-400		3 Comps: TT-300	2 Comps: TT-300/TT-400	
MS0270FL	270 TONS	2 Comps: TT-400	3 Comps: TT-400	3 Comps: TT-300	3 Comps: 1 TT-300/ 2 TT-400	
MS0300FL	300 TONS	2 Comps: TT-400	3 Comps: TT-400	Not Available	3 Comps: 1 TT-300/ 2 TT-400	
MS0330FL	330 TONS	3 Comps: TT-400	Not Available	4 Comps: TT-300	3 Comps: 1 TT-300/ 2 TT-400	
MS0360FL	360 TONS	3 Comps: TT-400	4 Comps: TT-400	4 Comps: TT-300	3 Comps: 1 TT-300/ 2 TT-400	
MS0390FL	390 TONS	3 Comps: TT-400	4 Comps: TT-400	Not Available		
MS0420FL	420 TONS	3 Comps: TT-400	4 Comps: TT-400			
MS0450FL	450 TONS	3 Comps: TT-400	4 Comps: TT-400			
MS0500FL	500 TONS	4 Comps: TT-400	5 Comps: TT-400			
MS0550FL	550 TONS	4 Comps: TT-400	5 Comps: TT-400			
MS0600FL	600 TONS	4 Comps: TT-400	5 Comps: TT-400			
400/460/575 Volt Flooded Chiller Model Data (Short Shells)						
Model #	Nominal Capacity	Frame 1	Frame 2	Frame 3	Frame 4	
MS0060FS	60 TONS	1 Comp: TT-300	Not Available			
MS0075FS	75 TONS	1 Comp: TT-300				
MS0090FS	90 TONS	1 Comp: TT-300				
MS0120FS	120 TONS	2 Comps: TT-300				
MS0150FS	150 TONS	2 Comps: TT-300				
MS0180FS	180 TONS	2 Comps: TT-300				
575 Volt Flooded Chiller Model Data (Long Shells)						
Model #	Nominal Capacity	Frame 1	Frame 2	Frame 3	Frame 4	
MS0060FL	60 TONS	Not Available				
MS0075FL	75 TONS					
MS0090FL	90 TONS					
MS0120FL	120 TONS					2 Comps: TT-300
MS0150FL	150 TONS					2 Comps: TT-300
MS0180FL	180 TONS					2 Comps: TT-300
MS0210FL	210 TONS					3 Comps: TT-300
MS0240FL	240 TONS					3 Comps: TT-300
MS0270FL	270 TONS					3 Comps: TT-300
MS0300FL	300 TONS					4 Comps: TT-300
MS0330FL	330 TONS	4 Comps: TT-300				
MS0360FL	360 TONS	4 Comps: TT-300				

# MagLev Water-Cooled Flooded

## PERFORMANCE DATA

For heat recovery, contact Multistack.

AHRI 550/590 Conditions (54/44 chilled water 85/95 condenser water)						
kW/ton						
Model #	Nominal Capacity	100%	75%	50%	25%	IPLV
MS0090FL	90 TONS	0.671	0.470	0.310	0.288	0.378
MS0180FL	180 TONS	0.601	0.442	0.296	0.263	0.356
MS0240FL	240 TONS	0.595	0.431	0.289	0.255	0.348
MS0300FL	300 TONS	0.587	0.430	0.288	0.256	0.347
MS0390FL	390 TONS	0.587	0.431	0.288	0.260	0.348
MS0450FL	450 TONS	0.590	0.429	0.288	0.256	0.346
MS0600FL	600 TONS	0.595	0.431	0.288	0.256	0.347

\*Note- Selections based off the following frame sizes:  
(MS090 & MS240 Frame 1) (MS180 Frame 4) (MS300, MS390, MS450, MS600 Frame 2)

Non-Standard Selection (54/44 chilled water 80/90 condenser water)						
kW/ton						
Model #	Nominal Capacity	100%	75%	50%	25%	NPLV
MS0090FL	90 TONS	0.610	0.445	0.310	0.287	0.367
MS0180FL	180 TONS	0.544	0.415	0.298	0.262	0.345
MS0240FL	240 TONS	0.538	0.404	0.289	0.255	0.336
MS0300FL	300 TONS	0.526	0.401	0.288	0.256	0.334
MS0390FL	390 TONS	0.526	0.402	0.288	0.260	0.335
MS0450FL	450 TONS	0.532	0.402	0.288	0.256	0.334
MS0600FL	600 TONS	0.538	0.404	0.288	0.256	0.335

\*Note- Selections based off the following frame sizes:  
(MS090 & MS240 Frame 1) (MS180 Frame 4) (MS300, MS390, MS450, MS600 Frame 2)

One big performance advantage of a centrifugal compressor is the ability to utilize condenser relief to lower the kW/ton of the chiller. Typically for every one degree reduction in entering condenser water temperature, the compressor is able to decrease its energy consumption by 2%.

This chart shows how reducing entering condenser water by five degrees on a MagLev centrifugal chiller, lowers overall energy consumption by 10% on average across the various chiller capacities.

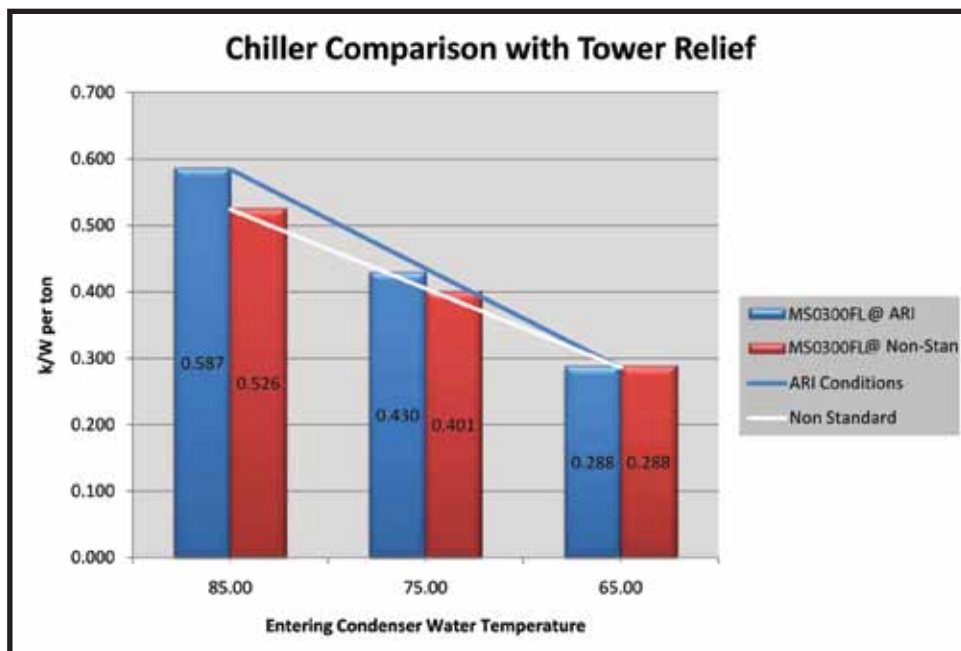

# MagLev Water-Cooled Flooded

## EVAPORATOR DATA

Evaporator Data							
Model #	Nominal Capacity	Min Flow	Min ΔP (PSI)	Design GPM	Design ΔP (PSI)	Max GPM	Max ΔP (PSI)
MSO090FL	90 TONS	90	1.13	216	5.50	360	13.80
MSO180FL	180 TONS	180	1.07	432	5.20	720	13.00
MSO240FL	240 TONS	260	1.14	576	4.80	1040	13.90
MSO300FL	300 TONS	325	1.12	720	4.70	1300	13.60
MSO390FL	390 TONS	435	1.13	936	4.50	1740	13.70
MSO450FL	450 TONS	540	1.12	1080	3.90	2160	13.60
MSO600FL	600 TONS	775	1.18	1440	3.60	3100	14.30

*Notes: Based on 2 Pass Evaporator and 2 Pass Condenser with 10ΔT.*

*Evaporators available in Pass Configurations of: 1,2,3,4,5,6*

*Condensers available in Pass Configurations of: 1,2,3,4*

*Performance data based on ARI 550/590 Standard. Please contact Multistack for application specific performance data.*

Illustration does not represent five and six pass evaporators because they are only available in S (short) models with a large ΔT.

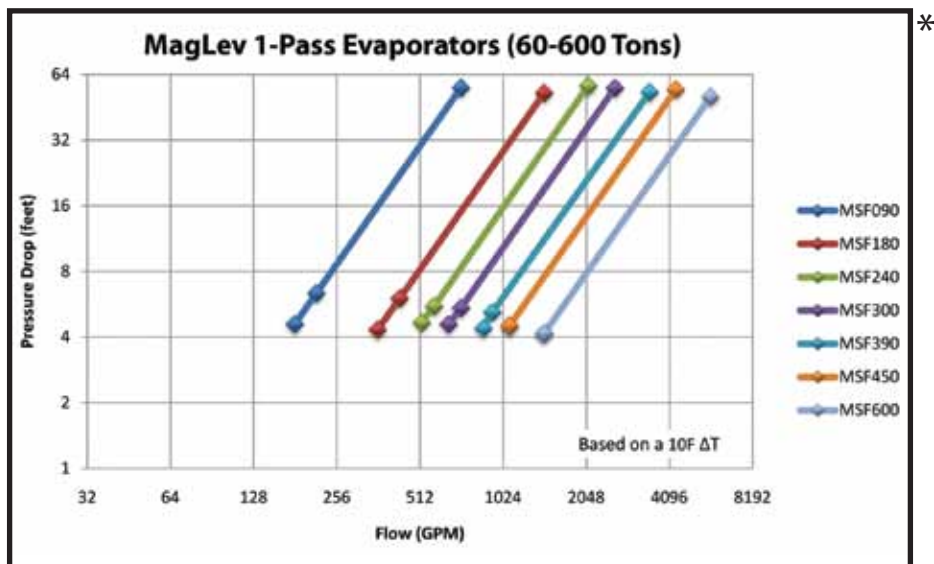
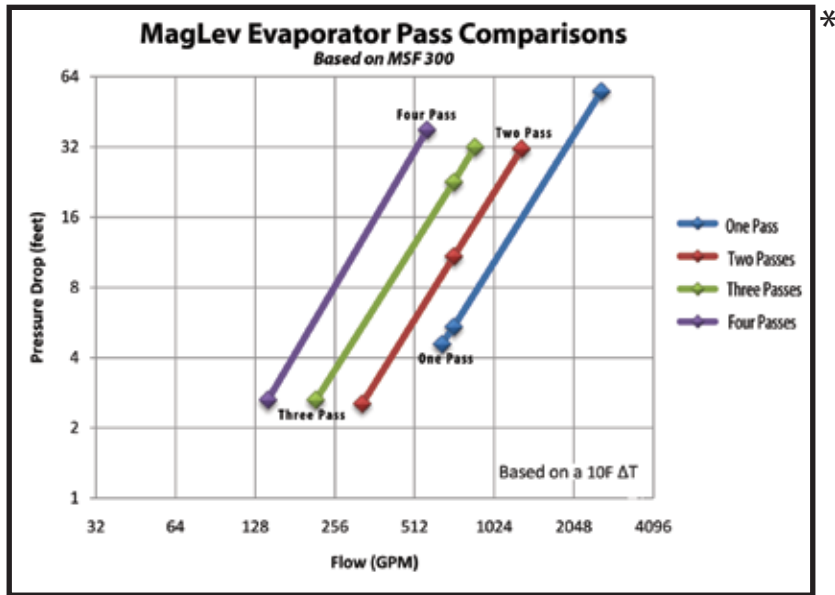

\*Charts on this page are created with logarithmic data to facilitate easy comparison illustrations.

# MagLev Water-Cooled Flooded EVAPORATOR DATA

MagLev Centrifugal Chillers with shell and tube flooded evaporators use GEWA-B finned tubes for optimum heat transfer. These tubes allow for compact design, high-performance and extremely low approaches.

The outside surface of GEWA-B tubes is designed to enhance the evaporation process via small channels heated by a high heat flux inside the tube. This engineering design generates a sizeable amount of bubbles that amplify the performance of the tube.

Standard tube diameter on MagLev Centrifugal Chillers is 3/4" I.D. The nominal tube thickness under the enhancements is .025".

Marine boxes available, for additional tube options please contact Multistack .

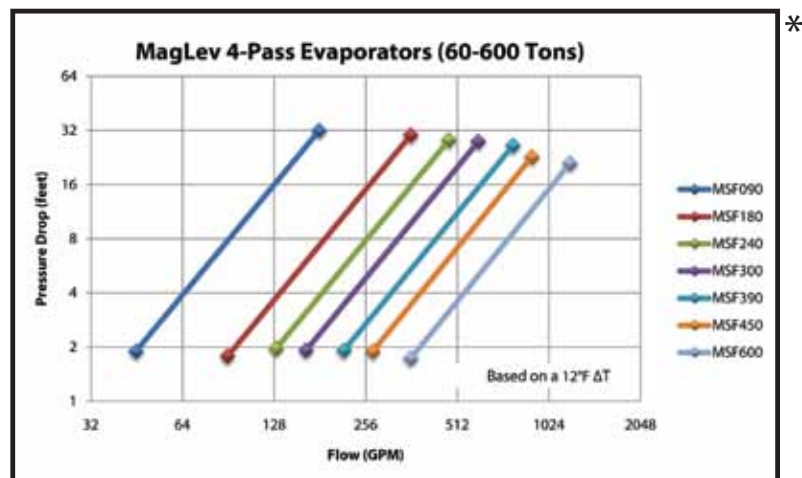
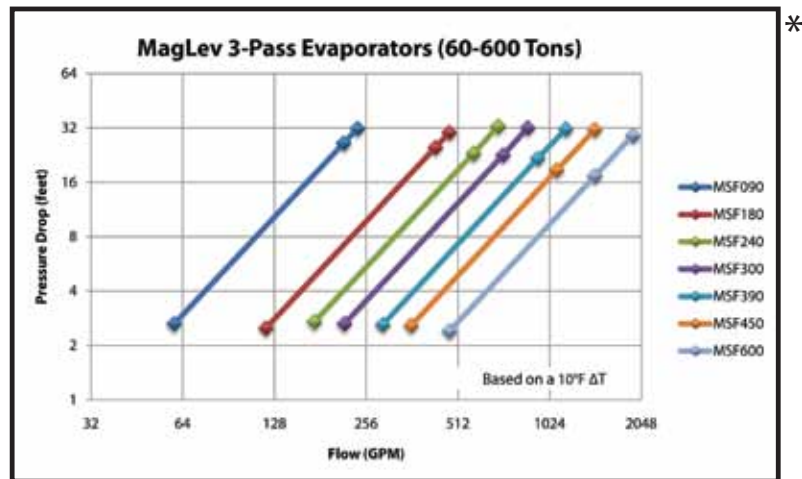
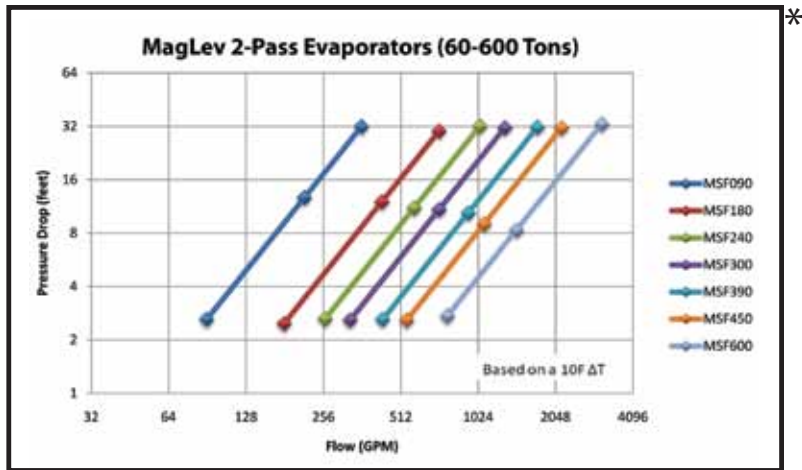

\*Charts on this page are created with logarithmic data to facilitate easy comparison illustrations.

# MagLev Water-Cooled Flooded

## CONDENSER DATA

MagLev Centrifugal Chillers with shell and tube flooded evaporators use GEWA-C finned tubes for optimum heat transfer. These tubes allow for compact design, high-performance and extremely low approaches.

The GEWA-C outside structure has been specially designed to enhance condensation and ensure a quick run-off of the condensed refrigerant.

Standard tube diameter on MagLev Centrifugal Chillers is 3/4" I.D. The nominal tube thickness under the enhancements is .025".

Marine boxes available, for additional tube options please contact Multistack .

Condenser Data							
Model #	Nominal Capacity	Min Flow	Min ΔP (PSI)	Design GPM	Design ΔP (PSI)	Max GPM	Max ΔP (PSI)
MSO090FL	90 TONS	100	1.07	270	6.40	400	13.00
MSO180FL	180 TONS	170	1.05	540	8.40	680	12.70
MSO240FL	240 TONS	240	1.11	720	8.00	960	13.40
MSO300FL	300 TONS	285	1.07	900	8.50	1140	13.00
MSO390FL	390 TONS	350	1.05	1170	9.20	1400	12.70
MSO450FL	450 TONS	410	1.04	1350	8.90	1640	12.60
MSO600FL	600 TONS	560	1.08	1800	8.80	2240	13.10

*Note: Based on 2 Pass Condenser with 10ΔT.*

*Condensers available in Pass Configurations of: 1,2,3,4*

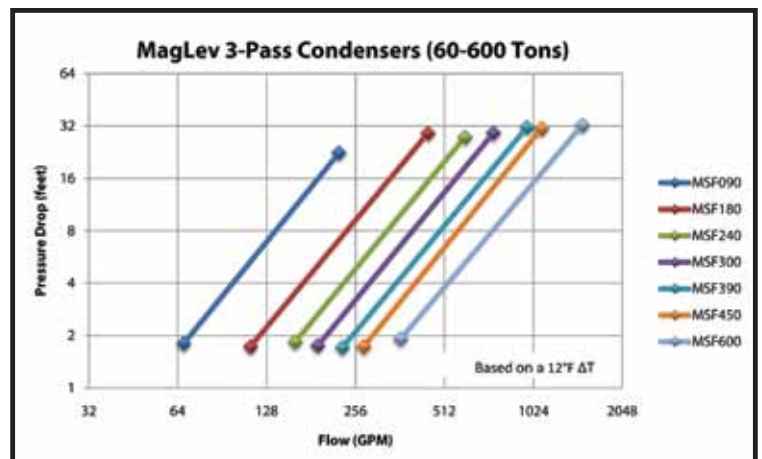
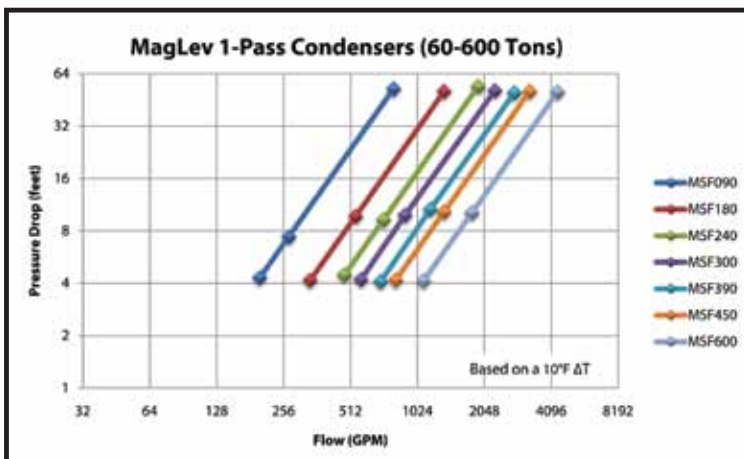
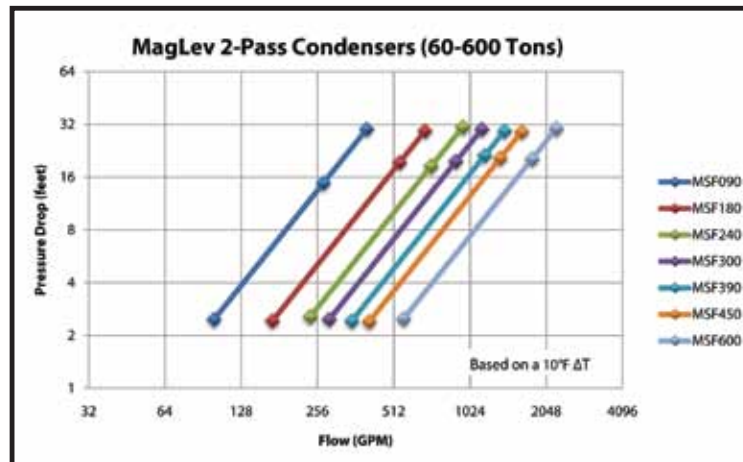

For Heat Recovery Options, contact Multistack.

## MagLev Water-Cooled Flooded ELECTRICAL DATA

MCA, RLA, Wire Size, Power connections option.

460 Volt Flooded Chiller Model Data (Long Shells)													
Model #	Nominal Capacity	Frame 1			Frame 2			Frame 3			Frame 4		
		RLA	MCA	MOP	RLA	MCA	MOP	RLA	MCA	MOP	RLA 1	MCA	MOP
MS0060FL	60 TONS	Not Available											
MS0075FL	75 TONS												
MS0090FL	90 TONS												
MS0120FL	120 TONS	51.1	115	150	106.4	133	175	Not Available					
MS0150FL	150 TONS	67.3	152	200	144.0	180	250						
MS0180FL	180 TONS	86.5	195	250	86.0	194	250						
MS0210FL	210 TONS	100.9	228	300	Not Available			61.5	200	250	81.7 / 101.3	300	250
MS0240FL	240 TONS	106.4	240	300				73.7	240	300	86.8 / 139.7	350	450
MS0270FL	270 TONS	124.2	280	400	79.4	259	300	86.5	282	350	64.5 / 87.9	300	350
MS0300FL	300 TONS	144.0	324	450	87.7	286	350	Not Available			75.4 / 96.6	350	400
MS0330FL	330 TONS	96.6	314	400	Not Available						76.9	327	400
MS0360FL	360 TONS	106.4	346	450				79.4	338	400	86.5	368	450
MS0390FL	390 TONS	117.7	383	500	85.8	365	450	Not Available			86.8 / 139.7	500	600
MS0420FL	420 TONS	131.4	428	500	92.1	392	450						
MS0450FL	450 TONS	144.0	468	600	98.9	421	500						
MS0500FL	500 TONS	111.8	476	500	87.7	461	500						
MS0550FL	550 TONS	127.7	543	600	96.6	508	600						
MS0600FL	600 TONS	144.0	612	700	106.4	559	600						

*NOTE: RLA's listed are per compressor. For compressor combinations, see chart on page 15.*

460 Volt Flooded Chiller Model Data (Short Shells)													
Model #	Nominal Capacity	Frame 1			Frame 2			Frame 3			Frame 4		
		RLA	MCA	MOP	RLA	MCA	MOP	RLA	MCA	MOP	RLA	MCA	MOP
MS0060FS	60 TONS	51.1	64	80	Not Available								
MS0075FS	75 TONS	67.3	85	110									
MS0090FS	90 TONS	86.5	109	150									
MS0120FS	120 TONS	51.1	115	150									
MS0150FS	150 TONS	67.3	152	200									
MS0180FS	180 TONS	86.5	195	250									

*NOTE: RLA's listed are per compressor. For compressor combinations, see chart on page 15.*

**575 Volt Flooded Chiller Model Data (Long Shells)**

		Frame 1			Frame 2			Frame 3			Frame 4				
Model #	Nominal Capacity	RLA	MCA	MOP	RLA	MCA	MOP	RLA	MCA	MOP	RLA	MCA	MOP		
MS0060FL	60 TONS	Not Available													
MS0075FL	75 TONS														
MS0090FL	90 TONS														
MS0120FL	120 TONS												41.1	93	125
MS0150FL	150 TONS												53.8	122	150
MS0180FL	180 TONS												69.2	156	200
MS0210FL	210 TONS												49.2	160	200
MS0240FL	240 TONS												58.9	192	250
MS0270FL	270 TONS												69.2	225	250
MS0300FL	300 TONS												53.8	229	250
MS0330FL	330 TONS												61.5	262	300
MS0360FL	360 TONS												69.2	295	350

*NOTE: RLA's listed are per compressor. For compressor combinations, see chart on page 15.*

**575 Volt Flooded Chiller Model Data (Short Shells)**

		Frame 1			Frame 2			Frame 3			Frame 4		
Model #	Nominal Capacity	RLA	MCA	MOP	RLA	MCA	MOP	RLA	MCA	MOP	RLA	MCA	MOP
MS0060FS	60 TONS	41.1	52.0	70.0	Not Available								
MS0075FS	75 TONS	53.8	68.0	90.0									
MS0090FS	90 TONS	69.2	87.0	110.0									
MS0120FS	120 TONS	41.1	93.0	125.0									
MS0150FS	150 TONS	53.8	122.0	150.0									
MS0180FS	180 TONS	69.2	156.0	200.0									

*NOTE: RLA's listed are per compressor. For compressor combinations, see chart on page 15.*

**SECTION 15400 MECHANICAL WATER CHILLER WATER COOLED  
Multistack® MagLev™ CENTRIFUGAL CHILLER**

PART 1- GENERAL

1.01 SUMMARY

Section includes design, performance criteria, refrigerants, controls, and installation requirements for Multistack water cooled centrifugal chillers.

1.02 REFERENCES

Comply with the following codes and standards:

- ARI 550/590-2003
- ANSI/ASHRAE 15
- ASME Section VIII
- NEC
- OSHA

1.03 SUBMITTALS

Submittals shall include the following:

- A. Chiller dimensional drawings with elevation overview. Drawings to include required service clearances, location of all field installed piping and electrical connections.
- B. A summary of all auxiliary utility requirements for normal system operation required. Auxiliary utility requirements include: electrical, water, and air. Summary of auxiliary equipment shall include quantity and quality of each specific auxiliary utility required.
- C. Chiller Control documentation to include: Chiller control hardware layout, wiring diagrams depicting factory installed wiring, field installed wiring with points of connection, and points of connection for BAS control/interface points.
- D. Sequence of operation depicting overview of control logic used
- E. Installation and Operating Manuals.
- F. Manufacturer certified performance data at full load in addition to either IPLV or NPLV.

1.04 QUALITY ASSURANCE

- A. Regulatory Requirements: Comply with the codes and standards as defined in Section 1.02 titled REFERENCES
- B. Chiller is required to be run test at manufacturer's facility to job specific requirements, prior to shipment. Report available upon request.

1.05 DELIVERY and HANDLING

- A1. Chillers shall be delivered to the job site completely assembled and charged with complete refrigerant charge.

OR

- A2. Chiller shall be delivered "knocked down" (optional). When "knocked down", chiller to arrive from factory with compressors, control panels, and necessary refrigerant components on skids for reassembly by installing contractor.

- B. Installing contractor to comply with the manufacturer's instructions for transporting, rigging, and assembly of chiller.

1.06 WARRANTY

- A. The manufacturer's equipment warranty shall be for a period of:

(1) One year from date of equipment start up or 18 months from the date of shipment, whichever occurs first.

- B. Extended warranty on parts and labor available by request.

- C. The warranty shall include parts and labor costs for the repair and or replacement of defects in components or workmanship.

1.07 MAINTENANCE

- A. Maintenance of the chiller shall be the sole responsibility of the owner.



**PART 2 - PRODUCTS****2.01 ACCEPTABLE MANUFACTURERS**

- A. Multistack LLC
- B. (Approved Equal)

**2.02 PRODUCT DESCRIPTION**

- A. Provide and install as shown on the plans a factory assembled, charged, and run tested, water-cooled packaged chiller.
- B. Each unit shall include: One or more MagLev<sup>®</sup>, oil-free, magnetic bearing, variable speed two stage centrifugal compressor equipped with inlet guide vanes and load balancing valve. Each compressor to utilize its integrated variable speed drive in conjunction with the compressors inlet guide vanes and load balancing valve, to optimize the chillers part load efficiency.
- C. The chillers evaporator, condenser, and electronic expansion valves shall be common to all compressors. The chiller shall operate with (1) one refrigerant circuit.
- D. Chiller shall utilize R-134A refrigerant only.

**2.03 DESIGN REQUIREMENTS**

- A. Provide a complete factory assembled or knocked down (optional) water cooled, oil free centrifugal chiller equipped with MagLev<sup>®</sup> compressors as specified herein. Chiller to be built in accordance to the standards defined in Section 1.02 of this specification.
- B. Chillers to utilize one of the following compressor arrangements for the specified nominal tonnages found on page 15.
- C. Each chiller shall be equipped with the following: One (1) flooded evaporator heat exchanger, one (1) water cooled condenser heat exchanger, one (1) or more MagLev<sup>®</sup> Compressors (refer to section 2.03 B) with integrated variable speed drive, soft start, magnetic bearings, and inlet guide vanes, two (2) or more electronic expansion valves, one (1) liquid level refrigerant sensor, one (1) load balance valve per compressor, one (1) master chiller control with necessary operating controls and system safeties, while all mechanical pressure safeties to be located at each individual compressor.
- D. Chiller Performance: Refer to performance schedule on the job specific drawings.
- E. Unloading: When utilizing MagLev<sup>®</sup> model TT-300 compressor (90 nominal tons), the chiller shall be capable of unloading to 15 tons. When using a MagLev<sup>®</sup> TT-350 compressor, chiller shall be capable of unloading to 30 tons. When using a MagLev<sup>®</sup> TT-400 compressor, chiller shall be capable of unloading to 35 tons. All unloaded capacity values are without the use of hot gas bypass.
- F. Loading: Chiller shall be able to lead lag compressor(s) without drastically unloading compressors on-line or creating check valve chatter on lag compressors. Total pressure ratio shall not be decreased below 2.4 pressure ratio as observed at the suction and discharge flanges of each individual compressor.
- G. Acoustics: Sound data shall be measured in accordance with ARI 575-87 Standard. Unit sound performance data shall be measured at the highest level recorded at all load points. Unit sound performance shall not exceed a level of 70 DBA measured at a distance of five (5) feet.
- H. Electrical: Chiller shall feature single-point power connection not utilizing adjoining power cabinets as pull boxes.
- I. Minimum Operating Conditions: Lowest evaporator saturated suction temperature shall not be below 34°F. Lowest leaving chilled water temperature shall not be below 38°F. Lowest entering condenser water temperature shall not drop below 55°F. A differential of 12°F between the leaving chilled water temperature and entering condenser water temperature is required to ensure chiller can maintain minimum lift requirements.

**2.04 CHILLER COMPONENTS**

- A. Compressors:
  - 1. Chiller to have one or more MagLev<sup>®</sup>, magnetic bearing, oil-free, two-stage, hermetical centrifugal compressor(s). Each compressor to contain integrated variable speed drive with soft start, movable inlet guide vane assembly, and weigh no more than 300 lbs.
  - 2. Each compressor to be microprocessor controlled. Each compressor to be networked to master controller via Etherbus connection with a refresh rate of 50 microseconds and the micro processor of each compressor to control the variable speed drive and inlet guide vanes on each compressor to maximize unit efficiency.
  - 3. Each compressor shall be capable of coming to a controlled safe stop in the event of a power outage. Unit shall be capable of auto restart in the event of a power outage, once power has been restored.
  - 4. All compressors are required to be mechanically and electrically isolated to facilitate proper maintenance, service, and or removal

### B. Refrigerant, Evaporator and Condenser:

1. All heat exchangers to be built in accordance to Section VIII of the ASME code and carry a manufacturer's name plate certifying ASME compliance.
2. The evaporator to be of shell and tube construction. Evaporator to be constructed of a single shell. Evaporator to be of flooded type with refrigerant surrounding the tubes and water passing through the tubes. Tubes to be enhanced and rifled. Minimum tube velocity of two (2) feet per second required. Design to not exceed a maximum tube velocity of eight (8) feet per second. Internal intermediate tube supports, liquid eliminator baffle plate, pressure relief vent, water drains and vents required. Pressure relief to be spring loaded self seating type in accordance to ASHRAE 15 standard. Evaporator to be pressure tested at a test pressure of 1.1 times the operating pressure however no less than 100 PSIG. Evaporator, water boxes, suction piping, and any other component subject to condensate shall be insulated with a UL recognized  $\frac{3}{4}$  inch or  $1\frac{1}{2}$ " closed cell insulation. All joints and seems to be sealed so a vapor barrier is created. Factory mounted differential pressure transmitters required for flow safety. Flow switches are not acceptable.
3. The condenser to be of shell and tube construction. Condenser to be constructed of a single shell. Condenser to be water cooled type with refrigerant surrounding the tubes and water passing through the tubes. Tubes to be enhanced and rifled. Minimum tube velocity of two (2) feet per second required. Design to not exceed a maximum tube velocity of eight (8) feet per second. Internal intermediate tube supports, pressure relief tree with isolation valves, water drain and vents required. Pressure relief tree to be equipped with isolation/transfer valve to prevent the loss of refrigerant when relief is removed for testing and or replacement. Rupture disks are not acceptable. Condenser to be pressure tested at a test pressure of 1.1 times the operating pressure however no less than 100 PSIG. Factory mounted differential pressure transmitters required for flow safety. Flow switches are no acceptable.
4. Heat Exchangers to feature enhanced and rifled individual tubes. Tubes shall be individually replaceable. Tubes shall be mechanically rolled into steel tube sheets and sealed with Loctite® or equivalent sealant. Tubes shall be supported by intermediate tube supports at a maximum spacing of 18" apart. Waterside to be designed to a minimum of 150 psig or 300 psig, whichever is specified. Heat exchangers to be equipped with either dished heads or marine boxes with drain and vent reports, whichever is specified. Piping connections to be either mechanical grooved connection or flange, whichever is specified.
5. Refrigerant Control: Chiller with multiple compressors to feature dual electronic expansion valves with a step count of 6386 steps to full open. A single compressor machine to have one electronic expansion valve with 6386 steps. Fixed orifices and float controls are not acceptable. The electronic expansion valve to operate from minimum chiller capacity to the full load of the chiller's capacity. A high side refrigerant level sensor, constructed out of stainless steel, with a stainless steel canister with sight glass is to be used to provide feedback to the expansion valves for proper control. This ensures that a proper liquid seal is always present on the compressors power electronics. A refrigerant sight glass is required on the main liquid line feeding the electronic expansion valves. Isolation valves before and after the EXV required for proper service without removing the entire refrigerant charge.

### C. Prime Mover:

1. The prime mover shall be of sufficient size to effectively meet the compressor horsepower requirements. Prime mover shall be a one or more liquid refrigerant cooled, hermetically sealed, permanent magnet synchronous motor. Motor shall be controlled by variable speed drive. Motor shall utilize soft start capabilities with an inrush current no greater than two (2) amps. Motor shall have internal thermal overload protection devices embedded in the winding of each phase of the motor.

### D. Variable Speed Drive:

1. The chiller shall be equipped with multiple variable speed drives unless one compressor is used. Please refer to section 2.03 B for compressor requirements. The variable speed drive to utilize Insulated Gate Bi-Polar Transistors. Variable speed drive to create it's own simulated AC voltage for the motor connected to it. Acceptable applied voltages are: 400 Volt 50 hertz, 460 Volt 60 hertz, and 575 volt 60 hertz. 575 volt applicable to TT-300 only.
2. Variable speed drive in conjunction with the compressors inlet guide vanes will be controlled via compressor microprocessor to optimally match the lift and load requirements.
3. Each compressor circuit is required to have a line reactor and circuit breaker.

#### E. Chiller Controls

The unit shall have an industrial grade cpu with an Intel-based processor. Chiller required to have fail to run mode. All chiller and compressor I/O to be controlled via Etherbus with an update rate of 50 microseconds. Controller to have 15 inch touch screen interface that can be disconnected and chillers still runs properly. Controller to use proprietary control logic to optimize loading, unloading, and control of multiple MagLev compressors. User shall operate chiller via HMI located on touch screen or remote web connection. All system parameters, compressor status, alarms, and faults, trend graphing, fault logging, bas communication window , manuals, wiring diagrams, log book, and control set points shall be viewable. Shall be able to fully commission and adjust all components on the chiller, including the compressors without an auxiliary computer or software.

The chiller controller shall include the following features:

- Hardware
- Two EXV Outputs
- Eight Digital Inputs
- Eight Digital Outputs
- Ten Analog Inputs
- Eight Analog Outputs (0-10 VDC)
- Eight Temperature Inputs
- One Compressor hub per compressor including:
  - Addressable Bus Coupler
  - RS-485 Module
  - RS-232 Module
  - Four Digital Inputs
  - Two Digital Outputs
- Windows®-based industrial PC featuring Intel® Processor for maximum reliability and performance.
- Dual-Hard drives for maximum reliability and redundancy. Hard drives feature no moving parts to ensure nothing mechanically fails. With dual-hard drives there is no need to partition a single drive. One drive handles the operating system while the other handles all data acquisition to ensure no data is corrupted.
- DC Powered to ensure maximum resistance to EMI and RFI noise
- Built in 2-port Ethernet Switch for easy integration to BAS interface and web control feature.
- Features industrial-style battery back-up in the event of a power outage
- On board USB drives to support external peripheral devices including, keyboard, mouse, and printer
- 15" TFT Display featuring 1024 X 768 Resolution.
- All hardware, including I/O is CE and UL Certified
- I/O features modular design to simplify troubleshooting and or replacement if required.
- I/O has LED Indicators for all inputs and outputs to ease the troubleshooting process.
- I/O can be directly connected to without the use of terminal blocks.
- All wiring utilizes spring capture technology to prevent loose connections or wires from falling out.
- Dedicated Ethernet communication at a communication rate of 50 microseconds to all compressors and I/O.
- MagLev hubs feature dedicated inputs for high pressure switch, low pressure switch, dedicated compressor interlocks, and dedicated compressor communications. This allows for each compressor to be handles independently by itself without affecting the rest of the system.

### Software

- Can control one (1) to eight (8) compressors on single or multiple refrigerant circuits
- Applications Include: Water Cooled Flooded Chillers, Water Cooled DX Chillers, Air Cooled Flooded Chillers, Air Cooled DX Chillers, DX Built Up Systems, Liquid Overfeed Systems, Modular Chillers, Heat Recovery Chillers
- Control System can control up to 24 EXVs with proper hardware and network all EXVs to the control system
- Control system capable of controlling different size compressors simultaneously.
- HMI interface is only control system on the market with a user definable points list, tag names, and functions without special software. With this feature, end user can scale an all inputs and outputs, change what controls it, change the functionality, the name of it etc.
- Control system can be field reconfigured through HMI to remap I/O to change functionality on the fly. This allows for customized integration into the end users system.
- Control system can trend graph up to two (2) years of data, without overwriting or decreasing data acquisition time
- Chiller controller utilizes the Danfoss Turbocor Compressor Software on board. This allows for no laptops for a service tech in addition to advanced remote troubleshooting.
- Control System features easy to use web interface. This allows the user to do anything remotely that could be done on sight
- Most advanced trend graphing available on the market. Over 200 data points are recorded in five (5) second intervals. Data can be analyzed with zoom feature. Data stored on separate 32 GB drive. Trend graph images can be exported. Trend graphs can be exported to csv files as well.
- Advanced Fault Logging featuring calendar capability for ease of use. Data can be recalled up to two (2) years. Data can be sorted by alarm type, time stamp, or compressor
- Color coded data. Green data means good, yellow means alarm, red means fault or off
- Controller logs when user makes any type of change
- Controller is loaded with all manuals, wiring diagrams, and supporting data which can be recalled via touch screen
- Controller has onboard maintenance log to store system information
- Controller features e-mail fault notification
- Controller offers real time capacity and efficiency data

### BAS Interfaces include:

- Modbus RTU
- Modbus TCP/IP
- BAC Net IP (optional)
- BACNET MSTP
- Lonworks (optional)
- BAS interface dashboard shown on HMI. This allows the user to view what data is being written to the BAS system. Also, it shows if there is an error, last com, and how many times the data was sent or received.
- Control system uses proprietary optimization logic to perform accurate energy balance on all systems for maximum system performance.
- Control System features an optimum start function to ensure initial lift is always made. This prevents nuisance check valve flutter and compressor faults.

## 2.05 OPTIONS

The following items are deemed optional and available upon request:

### Heat Exchangers-

- Heat exchanger designed for 300 PSI
- Marine water boxes
- Epoxy Coating
  - Tube Sheets
  - Heads
- Insulation
  - 1½ Closed Cell Foam
  - Metal Jacketed Insulation for outdoor use
- Dedicated Heat Recovery Option
- Multiple pass configurations to meet water side design criteria
- Heat exchanger lengths

### Electrical-

- Dual point of electrical connection
- Master chiller breaker
- EMI noise filtration to meet IEE 519 standards

### Controls-

- BACNET MSTP
- BACNET IP
- LONWORKS

### Warranties-

- Compressor warranties available by request.
- Chiller extended and labor warranties available by request.

### Other-

- Lifting Frame
- Vibration Isolation

## PART 3- EXECUTION

### 3.01 INSTALLATION

- A. Chiller must be installed per all of the manufacturer's documentation. This includes: IOM Manual, Submittal documentation, CAD Drawings, other.
- B. All local structural codes must be observed. Chiller to mounted and aligned on chiller pad or mounting rails as specified on CAD drawings.
- C. All local plumbing codes must be observed. Piping must be run in such a way that the proper required clearances for head removal for tube cleaning are observed.
- D. All National and Local Electrical codes must be observed. Installation of the electrical on the chiller must follow the associated documentation from the chiller manufacturer. Electrical installation shall be coordinated with electrical contractor. Controls installation shall be coordinated with the controls contractor.
- F. Provide all material required for a fully operational and functional chiller.

### 3.02 START-UP

- A. Units shall be factory charged with R-134A refrigerant unless unit is knocked down.
- B. Factory Start-Up Services: An authorized factory start agent is required. At minimum, (2) two days shall be spent on-site to ensure proper unit operation.
- C. During the start up period, the factory authorized agent will instruct the owner's representative on proper care and operation of the chiller.

## MagLev Water-Cooled Flooded ABOUT MULTISTACK

**M**ultistack, the modular chiller manufacturer was founded in 1989. Based in the heart of the American midwest, Sparta, Wisconsin, it is a privately held company. The focus of day-to-day business is developing elegant solutions to difficult situations accomplished by applying modular technology. The thought behind modular technology started out simply—design and manufacture chillers that fit through a standard doorway and on a regular freight elevator. This concept saves an incredible amount of labor and money during an installation or a retrofit.

A by-product of the modular concept is energy efficiency. In comparison to the standard centrifugal compressors they are replacing, the scroll-equipped modular units were proving to be much more energy efficient by being able to shut units off during low-demand periods. Additionally the modular Multistack units were saving money by having single point electrical and water connections. Through a period of 20 years, Multistack's modular concept took off and became a strategic part of the air and water cooled chiller market.

However, modular technology was not all that our customers wanted. There are times when a full-sized chiller makes more sense than an array of modules, but energy efficiency still would need to be at the heart of a Multistack full-sized chiller—with clear emphasis on unique features and abilities. Multistack answered our customers' requests with the release of a line of flooded chillers featuring Maglev compressors and FlexSys Control technology.





The FlexSys controller took over two years of development to create and when it was done it gave Multistack the ability to do something no one else in the magnetic levitation compressor market could do—control multiple sized compressors on the same frame. Units could be built with TT-300 and TT-400 compressors on the same chiller allowing for extreme turn down as well as maximum full-load efficiencies.

With sophisticated monitoring systems, the FlexSys controls allow each compressor to be monitored as a separate unit and thus, fine tuned to run at maximum efficiency 24 hours a day. By incorporating a unit mounted 15" touch-screen, a technician can make adjustments and changes to the chiller without having to plug in a laptop. Multistack flooded chillers with FlexSys controls can be monitored and controlled via computer from anywhere in the world, so in many cases a technician can take care of a concern without ever leaving the office. Add in the entire list of features found on page 10 and you have a chiller set to revolutionize the industry.

Every Multistack chiller is run tested in the factory prior to shipping. This verification of systems allows you to rest assured your Multistack chiller will arrive ready to go. And Multistack is more than just a chiller sales company. Our service department travels the world assisting in new chiller start-ups, training technicians to maintain Multistack products and offering service schools in our Sparta, Wisconsin home office.

The final note on Multistack chillers, modular and flooded is AHRI certification. All new chillers manufactured by Multistack meet or exceed the standards set by AHRI, assuring you consistent, repeated quality performance and the comfort of knowing your equipment will do exactly what you paid to have it do.

 **MULTISTACK**<sup>®</sup>  
Originators. Innovators. Never the Imitators.<sup>SM</sup>

1065 Maple Avenue Sparta, WI • P 608-366-2400 • F 608-366-2450

[www.multistack.com](http://www.multistack.com)



F155FUDC0812